



ALL TERRAIN CRANE 210 TONS

LINK-BELT ATC-3210

BOOM LENGTHS:

44 TO 200 FT

JIB LENGTHS:

12 TO 117 FT

JIB OFFSETS:

2 - 15 - 30 - 45



NOTES:

Table of Contents

Page	Contents
2-3	Operating Instructions
4	General Dimensions
4	Pontoon Loadings
4	Tire Inflation
5	Boom Extend Modes
6	Winch Performance
6	Wire Rope Capacity
7	Working Areas
7	Backward Stability
8	Capacity Deductions
8	Wind Speed Restrictions
9	Allowable Counterweight Configurations
10	Allowable Crane Configurations
11	Working Range Diagram - Main Boom
12	Working Range Diagram - Main Boom + Attachments
	<u>Fully Extended Outrigger Capacities</u>
13-15	Lifting Capacities, 0# Counterweight
16-18	Lifting Capacities, 14,000# Counterweight
19-54	Lifting Capacities, 36,000# Counterweight
55-120	Lifting Capacities, 58,000# Counterweight
121-186	Lifting Capacities, 71,500# Counterweight
187-252	Lifting Capacities, 80,000# Counterweight
253-318	Lifting Capacities, 102,000# Counterweight
319-381	Lifting Capacities, 115,500# Counterweight



PORTLAND OFFICE: 503.283.3111
 SEATTLE OFFICE: 206.784.1054
WWW.NESSCAMPBELL.COM

Operating Instructions

General:

1. Rated lifting capacities in pounds as shown on lift charts pertain to this crane as originally manufactured and normally equipped by Link-Belt Construction Equipment Company (LBCE). Modifications to the crane or use of optional equipment other than that specified can result in a reduction in capacity.
2. Construction equipment can be dangerous if improperly operated or maintained. Operation and maintenance of this crane must be in compliance with the information in the Operator's, Parts, and Safety Manuals supplied with this crane. If these manuals are missing, order replacements through the distributor.
3. The operator and other personnel associated with this crane shall read and fully understand the latest applicable American National Standards Institute (ANSI) and American Society of Mechanical Engineers (ASME) safety standards for cranes.
4. All rated lifting capacities listed in this Crane Rating Manual are in compliance with ANSI/ASME B30.5, SAE J1063, and SAE J765 in effect at the time of manufacture.
5. The rated lifting capacities are based on crane standing level on firm supporting surface.

Set Up:

1. The crane shall be leveled on a firm supporting surface. Depending on the nature of the supporting surface, it may be necessary to have structural supports under the outrigger pontoons or tires to spread the load to a larger bearing surface.
2. When making lifts on outriggers, all tires must be free of supporting surface. All outrigger beams must be extended to the same length; fully retracted, intermediate extended, or fully extended.
3. When making lifts on tires, they must be inflated to the recommended pressure. (See "Tire Inflation".)
4. When on tires with 0 lb counterweight, the boom can only be lowered to 0° with boom centered over front. Do not swing with any counterweight installed on upper.
5. When on retracted outriggers, the boom can only be lowered to 0° when over front or over rear.
6. For required parts of line, see "Wire Rope Capacity Chart" and "Winch Performance".
7. Before setting up the crane, refer to "Allowable Crane Configurations" and rated lifting capacities to determine allowable crane configurations.

Operation:

1. Rated lifting capacities at rated radius shall not be exceeded. Do not tip the crane to determine allowable loads.
2. Rated lifting capacities shall be reduced for repetitive lift applications. For concrete bucket operation, weight of bucket and load shall not exceed 80% of rated load. For duty cycle operation, such as loading and unloading, maximum allowable load shall not exceed 70% of rated load. For clamshell and magnet operation, weight of bucket, or magnet, and load shall not exceed 70% of rated load. Lifts with fly erected are prohibited for clamshell and magnet operation.
3. Rated lifting capacities shown on fully extended outriggers do not exceed 85% of the tipping loads. Rated lifting capacities shown on intermediate extended or fully retracted outriggers are determined by the formula, rated load = (tipping load - 0.1 X load factor)/1.25. Rated lifting capacities shown on tires do not exceed 75% of the tipping loads.
4. Rated lifting capacities in the shaded areas are governed by factors other than those that would cause a tipping condition.
5. Rated lifting capacities must deduct the weight of the hook block, hook ball, slings, bucket, magnet, auxiliary lifting devices, etc. to obtain the net load that can be lifted. Their weights are considered part of the lifted load. Rated lifting capacities include the deduct for fly stowed on the base of the boom. For deducts of any fly erected, but not used, see "Capacity Deductions".
6. Rated lifting capacities are based on freely suspended loads. No attempt shall be made to move a load horizontally on the ground in any direction.
7. Rated lifting capacities are for lift crane service only.
8. Do not operate at radii or boom lengths (minimum or maximum) where capacities are not listed. At these positions, the crane can tip or cause boom failure.
9. The maximum loads which can be telescoped are not definable because of variation in loadings and crane maintenance, but it is permissible to attempt retraction and extension within the limits of the applicable load rating chart.



PORTLAND OFFICE: 503.283.3111
SEATTLE OFFICE: 206.784.1054

WWW.NESSCAMPBELL.COM

10. Lifting capacities are based on fixed boom lengths. The rated capacities as shown on the load rating charts are available only when the boom sections are pinned. For boom lengths between those shown, the capacity is determined by the capacity at the shorter boom length, the capacity at the longer boom length, or the unpinned capacity for the longer boom length, whichever is smallest.
11. When the load radius is between those listed, use rating for the next larger radius.
12. The user shall operate at reduced ratings to allow for adverse job conditions such as: soft or uneven ground, out of level conditions, wind, side loads, pendulum action, jerking, or sudden stopping of loads, hazardous conditions, experience of personnel, traveling with loads, electrical wires, etc. Side load on boom and/or fly is dangerous and shall be avoided.
13. Rated lifting capacities do not account for the effects of wind on a suspended load or boom. See "Wind Speed Restrictions" for allowed wind speed operation and appropriate capacity reduction.
14. For cold weather operation, rated capacities should be reduced by the following rule: a 1% reduction in rated capacity should be taken for each 1°F below 0°F. Example: if the temperature is -10°F a 10% reduction in rated capacities should be taken, at -40°F a 40% reduction.
15. Heat from the sun only on one side of the boom may cause a temperature differential in the sides of the boom. The thermal effects may cause the boom to distort (bend to one side) creating a side load on the boom and/or fly. Side loading is dangerous and shall be avoided. Refer to the Operator's Manual for more instructions.
16. For auxiliary lifting sheave capacities, use main boom charts minus auxiliary lifting sheave deduct. (See "Capacity Deductions".) The effective length of the boom increases by 2'.
17. Rated lifting capacities are based on correct reeving. A deduction must be made for excessive reeving. Any reeving over minimum required is considered excessive and must be accounted for when making lifts. Use the Working Range Diagram to estimate the extra length of rope, then deduct the required rope weight (listed on the Wire Rope Capacity Chart) for the extra length of wire rope before attempting to lift a load.
18. The loaded boom angle combined with the boom length gives only an approximation of the operating radius. The boom angle, before loading, should be greater to account for deflection. Some capacities are limited by a maximum obtainable 82.5° boom angle.
19. Rated lifting capacities on tires depend on tire capacity, condition of tires, and tire air pressure. On tire capacities require lifting from main boom head only with the crane supported on a smooth, firm, and level surface. On tire lifting operations

require the travel switch to be in the jobsite position. For pick & carry operation, the boom must be centered over the rear of the crane with two position travel swing lock engaged. Travel is limited to 1.0 mph maximum and the load must be restrained from swinging. Lifts on tires with any fly erected are prohibited. For correct tire pressure, see "Tire Inflation".

20. Rated lifting capacities shown for the 12' offset fly also apply to the 12' hydraulic offset fly.

Definitions:

1. Loaded Boom Angle In Degrees: The angle between the boom base section and horizontal with freely suspended load at the rated radius.
2. Load Radius: Horizontal distance from a projection of the centerline of rotation to the supporting surface, before loading, to the center of the vertical hoist line or tackle with load applied.
3. Working Area: Area measured in a circular arc about the centerline of rotation as shown on the Working Areas Diagram.
4. Freely Suspended Load: Load hanging free with no direct external force applied except by the hoist line.
5. Side Load: Horizontal side force applied to the lifted load either on the ground or in the air.
6. No Load Stability Limit: The radius or boom angle beyond which it is not permitted to position the boom because the crane can overturn without any load on the hook.
7. Load Factor: Load applied at the boom tip which gives the same moment effect as the boom mass.



PORTLAND OFFICE: 503.283.3111
SEATTLE OFFICE: 206.784.1054

WWW.NESSCAMPBELL.COM

General Dimensions

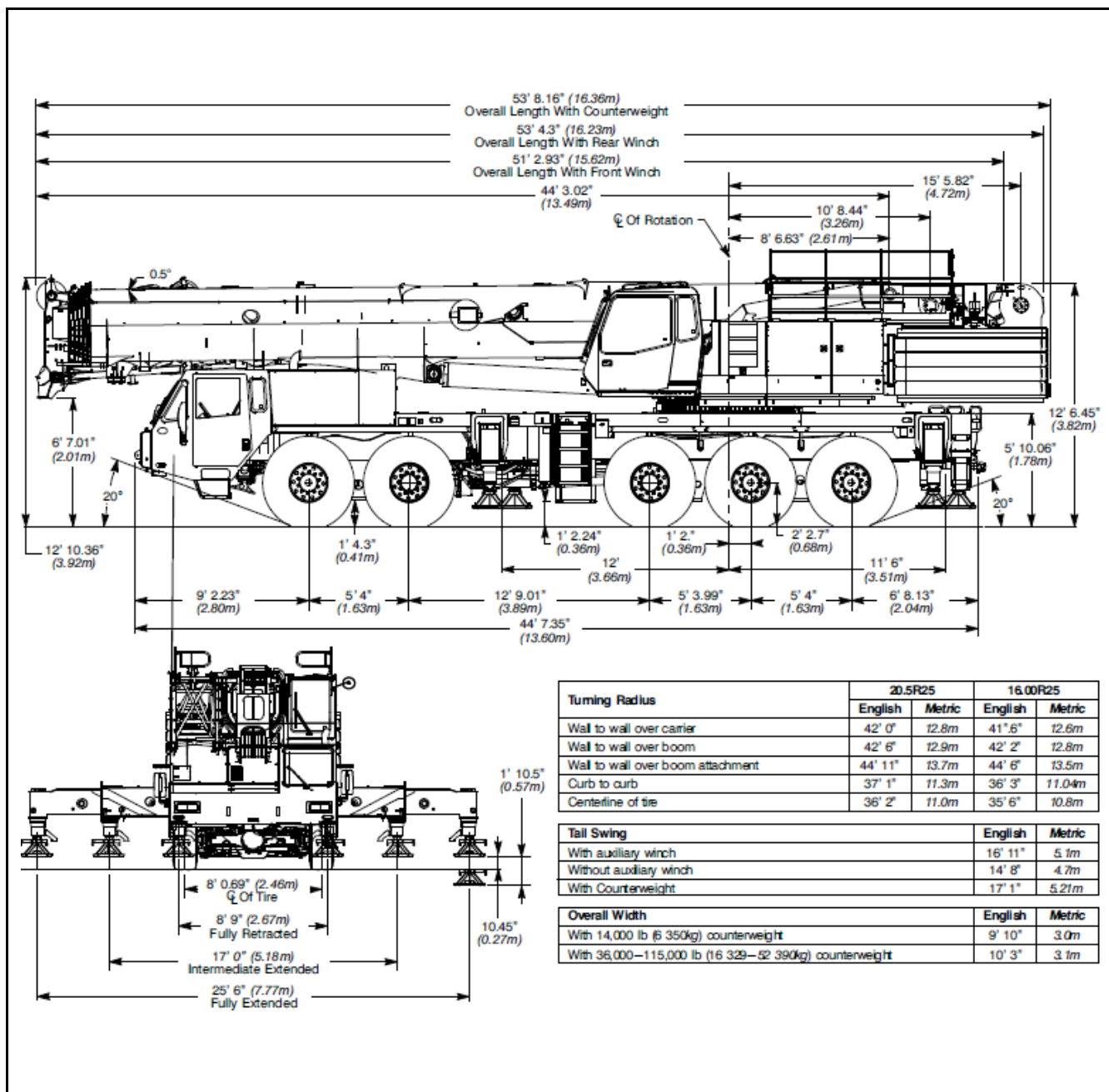

Pontoon Loadings

Maximum Pontoon Load (lb)	Pressure (psi)
200,000 - Base Rating Only	519
175,000	455

Tire Inflation

Tire Size	Operation	Pressure (psi)
525/80 R25	Over Rear 0 to 1 mph 360° Stationary	102
445/95 R25	Over Rear 0 to 1 mph 360° Stationary	131



PORTLAND OFFICE: 503.283.3111
 SEATTLE OFFICE: 206.784.1054
WWW.NESSCAMPBELL.COM

Boom Extend Modes

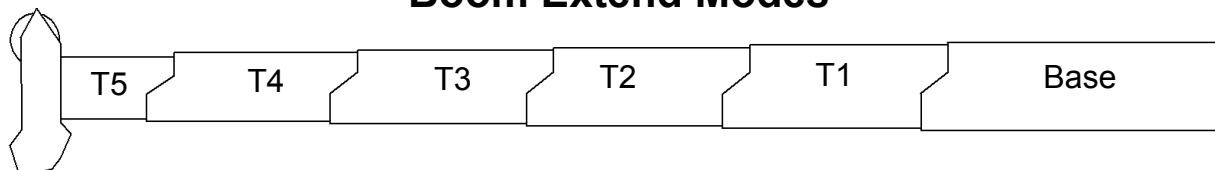

EM 1	Boom Length (ft)					
		T5	T4	T3	T2	T1
	44.3					
	73.5	100%				
	103.8	100%	100%			
	134.9	100%	100%	100%		
	167.1	100%	100%	100%	100%	
	183.6	100%	100%	100%	100%	50%
	200.1	100%	100%	100%	100%	100%

EM 2	Boom Length (ft)					
		T5	T4	T3	T2	T1
	44.3					
	58.9	50%				
	89.1	50%	100%			
	120.3	50%	100%	100%		
	152.4	50%	100%	100%	100%	
	169.0	50%	100%	100%	100%	50%
	185.5	50%	100%	100%	100%	100%

EM 3	Boom Length (ft)					
		T5	T4	T3	T2	T1
	44.3					
	73.5	100%				
	103.8	100%	100%			
	119.4	100%	100%	50%		
	135.4	100%	100%	50%	50%	
	152.0	100%	100%	50%	50%	50%
	168.5	100%	100%	50%	50%	100%

EM 4	Boom Length (ft)					
		T5	T4	T3	T2	T1
	44.3					
	73.5	100%				
	88.6	100%	50%			
	104.2	100%	50%	50%		
	120.3	100%	50%	50%	50%	
	136.8	100%	50%	50%	50%	50%
	153.4	100%	50%	50%	50%	100%

EM 5	Boom Length (ft)					
		T5	T4	T3	T2	T1
	44.3					
	58.9	50%				
	74.0	50%	50%			
	89.6	50%	50%	50%		
	105.7	50%	50%	50%	50%	
	122.2	50%	50%	50%	50%	50%

EM 6	Boom Length (ft)					
		T5	T4	T3	T2	T1
	44.3					
	59.4		50%			
	75.0		50%	50%		
	91.0		50%	50%	50%	
	107.6		50%	50%	50%	50%
	124.1		50%	50%	50%	100%

EM 7	Boom Length (ft)					
		T5	T4	T3	T2	T1
	44.3					
	59.9			50%		
	75.9			50%	50%	
	92.5			50%	50%	50%



PORTLAND OFFICE: 503.283.3111
 SEATTLE OFFICE: 206.784.1054
WWW.NESSCAMPBELL.COM

Winch Performance

Wire Rope Layer	Winch Line Pulls		Drum Rope Capacity (ft)	
	Two Speed Winch			
	Low Speed	High Speed	Layer	Total
	Available (lb*)	Available (lb)		
1	25,955	11,574	125	125
2	23,418	10,443	138	263
3	21,332	9,513	152	414
4	19,588	8,735	165	579
5	18,108	8,075	179	758
6	16,835	7,507	192	950

*Maximum lifting capacity: Type ZB Rope=20,943 lb, Type YB Rope=21,680 lb

Wire Rope Capacity Chart

Maximum Lifting Capacities Based on Wire Rope Strength		
Parts of Line	22 mm	22 mm
	Type ZB	Type YB
1	20,943	21,680
2	41,886	43,360
3	62,829	65,040
4	83,772	86,720
5	104,715	108,400
6	125,658	130,080
7	146,601	151,760
8	167,544	173,440
9	188,487	195,120
10	209,430	216,800
11	230,373	238,480
12	251,316	260,160
13	272,259	281,840
14	293,202	303,520
15	314,145	325,200
16	335,088	346,880
17	356,031	368,560
18	376,974	390,240
19	397,917	411,920
Rope Weight - lbs/ft	1.5	1.6
LBCE Type	Description	
ZB	34 x 7 Non-Rotating, E.I.P.S., Right Regular Lay or Right Lang Lay	
YB	34 x 7 Rotation Resistant - WSC - Compacted Strand - Right Lang Lay	

Notes:

- Capacities shown are in pounds and working loads must not exceed the ratings on the capacity charts in this Crane Rating Manual.
- Capacity deducts for auxiliary lifting devices do not apply for wire rope strength capacities.
- Special reeving is required for more than 14 parts of line. Special equipment is required for greater than 16 parts of line.
- Refer to Operator's Manual for wire rope inspection procedures, single part of line applications, and reeving diagrams.
- Rated lifting capacity of 420,000 lbs requires special handling of load per ASME B30.5 operating practices.



PORTLAND OFFICE: 503.283.3111
SEATTLE OFFICE: 206.784.1054
WWW.NESSCAMPBELL.COM

Working Areas

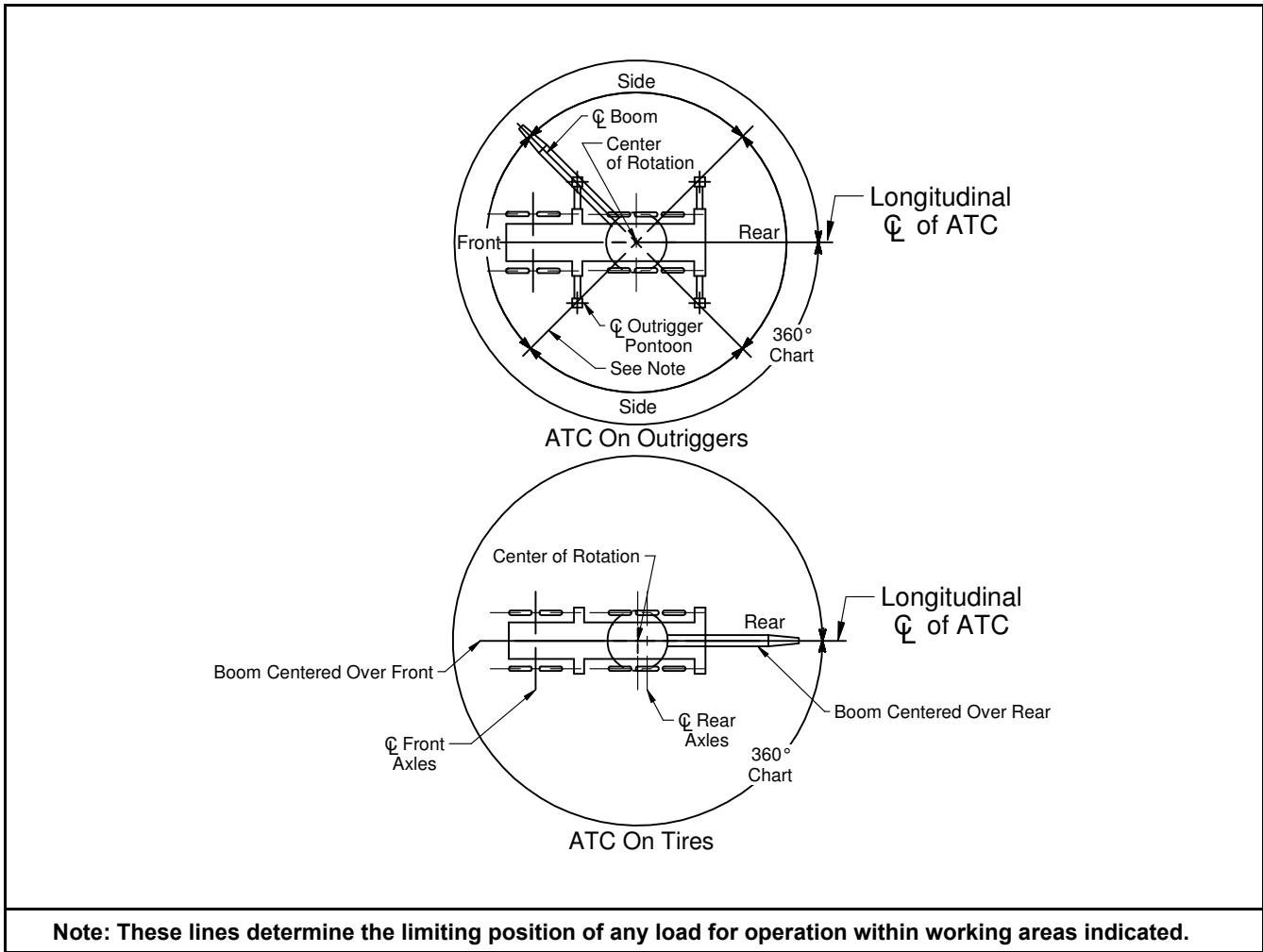

Backward Stability - Maximum Boom Angle

Counterweight (lb)	On Tires	Outrigger Position		
		Retracted	Intermediate	Full
0	71°	82.5°	82.5°	82.5°
14,000	54°	79°		
36,000	0°	62°		
58,000	0°	40°		
71,500	0°	17°	75°	82.5°
80,000	0°	0°	73°	
102,000	0°	0°	61°	
115,500	0°	0°	53°	

Maximum boom angle on outriggers is based on retracted boom at the least stable over side position.

Maximum boom angle on tires is based on retracted boom at the least stable over front position.



PORTLAND OFFICE: 503.283.3111
 SEATTLE OFFICE: 206.784.1054
WWW.NESSCAMPBELL.COM

Capacity Deductions

Load Handling Equipment	Weight (lb)
35 Ton Quick Reeve 1 Sheave Hook Block (See Hook Block For Actual Weight)	1,100
40 Ton Quick Reeve 1 Sheave Hook Block (See Hook Block For Actual Weight)	1,454
66 Ton Quick Reeve 3 Sheave Hook Block (See Hook Block For Actual Weight)	1,916
100 Ton Quick Reeve 5 Sheave Hook Block (See Hook Block For Actual Weight)	2,250
140 Ton Quick Reeve 7 Sheave Hook Block (See Hook Block For Actual Weight)	2,850
200 Ton Quick Reeve 10 Sheave Hook Block (See Hook Block For Actual Weight)	3,446
210 Ton Quick Reeve 10 Sheave Hook Block (See Hook Block For Actual Weight)	3,745
12 Ton Hook Ball (See Hook Ball For Actual Weight)	720
15 Ton Hook Ball (See Hook Ball For Actual Weight)	1,211

Auxiliary Lifting Devices	Weight (lb)	
Auxiliary Lifting Sheave Attached	120	
Lifting From Main Boom With:	Boom Length (ft)	
	44.3 - 134.9	135.0 - 200.1
12', 40', 67' Fly Stowed on Boom Base (See Operation Note 5)	0	0
12' Offset Fly Erected But Not Used	5,500	3,300
40' Offset Fly Erected But Not Used	18,300	6,600
67' Offset Fly Erected But Not Used	36,900	11,300
92' Offset Fly Erected But Not Used	Prohibited	Prohibited
117' Offset Fly Erected But Not Used	Prohibited	Prohibited
Lifting From 12' or 40' Fly With:		
28' Fly Center Erected But Not Used	Prohibited	Prohibited
27' Fly Tip Erected But Not Used	Prohibited	Prohibited
27' Fly Tip Stowed On 40' Fly	Prohibited	Prohibited
Note: Capacity deductions are for Link-Belt supplied equipment only.		

Wind Speed Restrictions

If The Wind Speed Is:	Rated Capacities Must Be Reduced By At Least:
Main Boom	
0-16 mph	Normal Lifting Operations (See Capacity Charts)
17-23 mph	40%
24-31 mph	70%
32 mph or greater	Crane operation must be shutdown and the boom retracted and lowered to horizontal.
12' - 117' Fly	
0-11 mph	Normal Lifting Operations (See Capacity Charts)
12-18 mph	40%
19-24 mph	70%
25 mph or greater	Crane operation must be shutdown and the boom retracted and lowered to horizontal.
<p>* Additional reductions are required for loads with large wind sail area.</p> <p>* These restrictions are based on crane on fully extended outriggers.</p> <p>* When wind speed for normal operation is exceeded, the operator shall add 10° to all minimum boom angles due to no load stability and shall not boom down below that angle.</p>	



PORTLAND OFFICE: 503.283.3111
 SEATTLE OFFICE: 206.784.1054
WWW.NESSCAMPBELL.COM

Allowable Counterweight Configurations

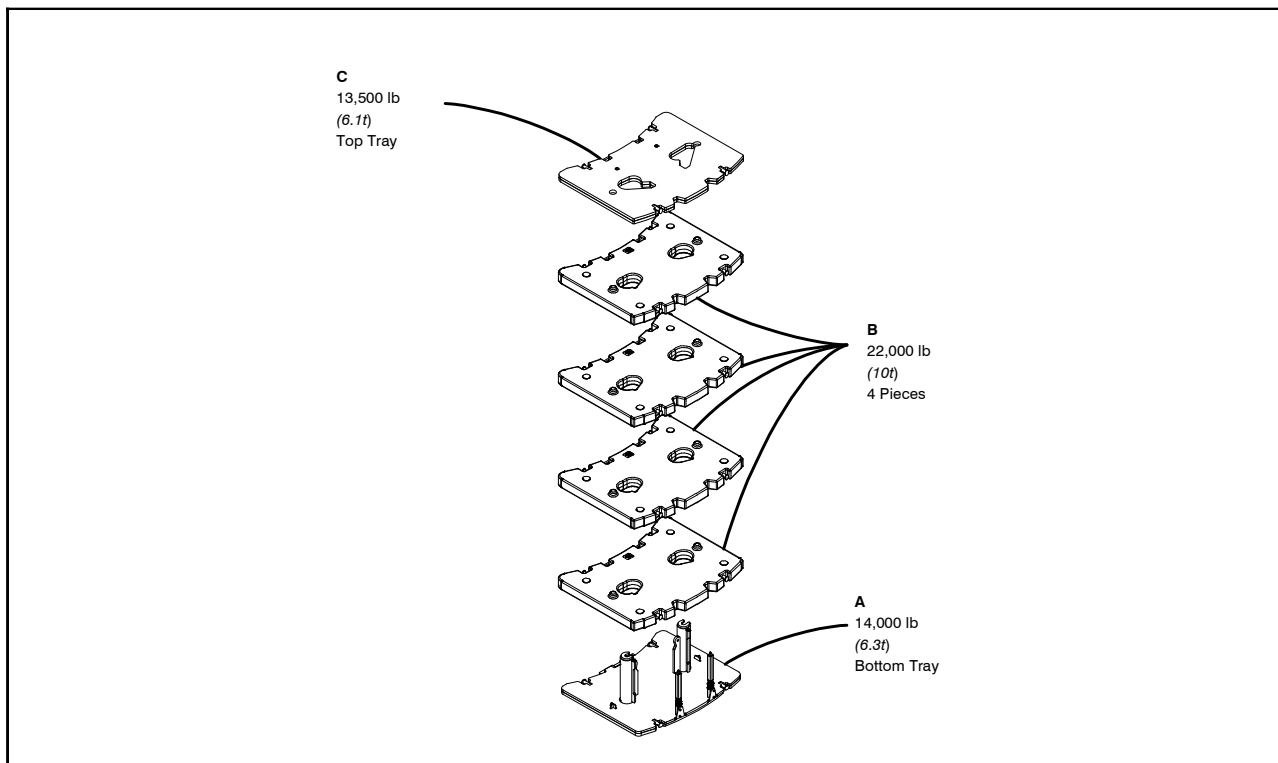

Counterweight Packages			36,000 lb (16.3t) - Standard					
			80,000 lb (36.3t) - Optional					
			115,500 lb (52.4t) - Optional					
Counterweight Modules			A 14,000 lb (6.3t)	B 22,000 lb (10t)	B 22,000 lb (10t)	B 22,000 lb (10t)	B 22,000 lb (10t)	C 13,500 lb (6.1t)
Counterweight Usage Configurations	0	0						
	A	14,000 lb (6.3t)	X					
	A,B	36,000 lb (16.3t)	X	X				
	A,B,B	58,000 lb (26.3t)	X	X	X			
	A,B,B,C	71,500 lb (32.4t)	X	X	X			X
	A,B,B,B	80,000 lb (36.3t)	X	X	X	X		
	A,B,B,B,B	102,000 lb (46.3t)	X	X	X	X	X	
A,B,B,B,B,C	115,500 lb (52.4t)	X	X	X	X	X	X	



PORTLAND OFFICE: 503.283.3111
 SEATTLE OFFICE: 206.784.1054
WWW.NESSCAMPBELL.COM

Allowable Crane Configurations - Main Boom

		Boom Length (ft)							
O/R Position	Ctwt (lb)	EM1	EM2	EM3	EM4	EM5	EM6	EM7	
Full	0	44.3- 134.9	44.3- 120.3	44.3- 152	44.3- 136.8	44.3- 122.2	44.3- 107.6	44.3- 92.5	
	14,000	44.3- 183.6	44.3- 169.0	44.3- 168.5	44.3- 153.4		44.3- 124.1		
	36,000	44.3- 200.1	44.3- 185.5						
	58,000								
	71,500								
	80,000								
	102,000								
115,500									
Intermediate	0	44.3- 103.8	44.3- 89.1	44.3- 119.4	44.3- 104.2	44.3- 89.6	44.3- 75.0	44.3- 75.9	
	14,000	44.3- 134.9	44.3- 120.3	44.3- 151.9	44.3- 136.8	44.3- 122.2	44.3- 105.7	44.3- 91.0	
	36,000						44.3- 107.6		
	58,000						44.3- 124.1	44.3- 92.5	
	71,500								
	80,000								
	102,000						Prohibited		
115,500	44.3								
Retracted	0								
	14,000								44.3- 103.8
	36,000 - 115,500								
On Tires Stationary	0 on Upper 0 -115,000 on Carrier	44.3- 73.5	Prohibited						
On Tires 0 - 1 mph	0 -36,000								
	58,000								
	71,500								44.3- 103.8
	80,000								
	102,000 - 115,500								

Main Boom + Attachments

		Boom Length With Fly (ft)							
O/R Position	Ctwt (lb)	12' Fly	40' Fly	67' Fly	92' Fly	117' Fly			
Full	0 - 14,000	Prohibited							
	36,000	EM1 - EM7	EM1: 44.3 -200.1						
	58,000 - 115,500		EM2: 44.3 -185.5 EM3: 44.3 -168.5						
Intermediate	0 - 58,000								
	71,500-80,000						EM1 - EM7	EM1: 44.3 -200.1 EM2: 44.3 -185.5 EM3: 44.3 -168.5	
	102,000-115,500						Prohibited		
Retracted	0 - 115,500								
On Tires	0 - 115,500								



PORTLAND OFFICE: 503.283.3111
 SEATTLE OFFICE: 206.784.1054
WWW.NESSCAMPBELL.COM

Working Range Diagram Main Boom

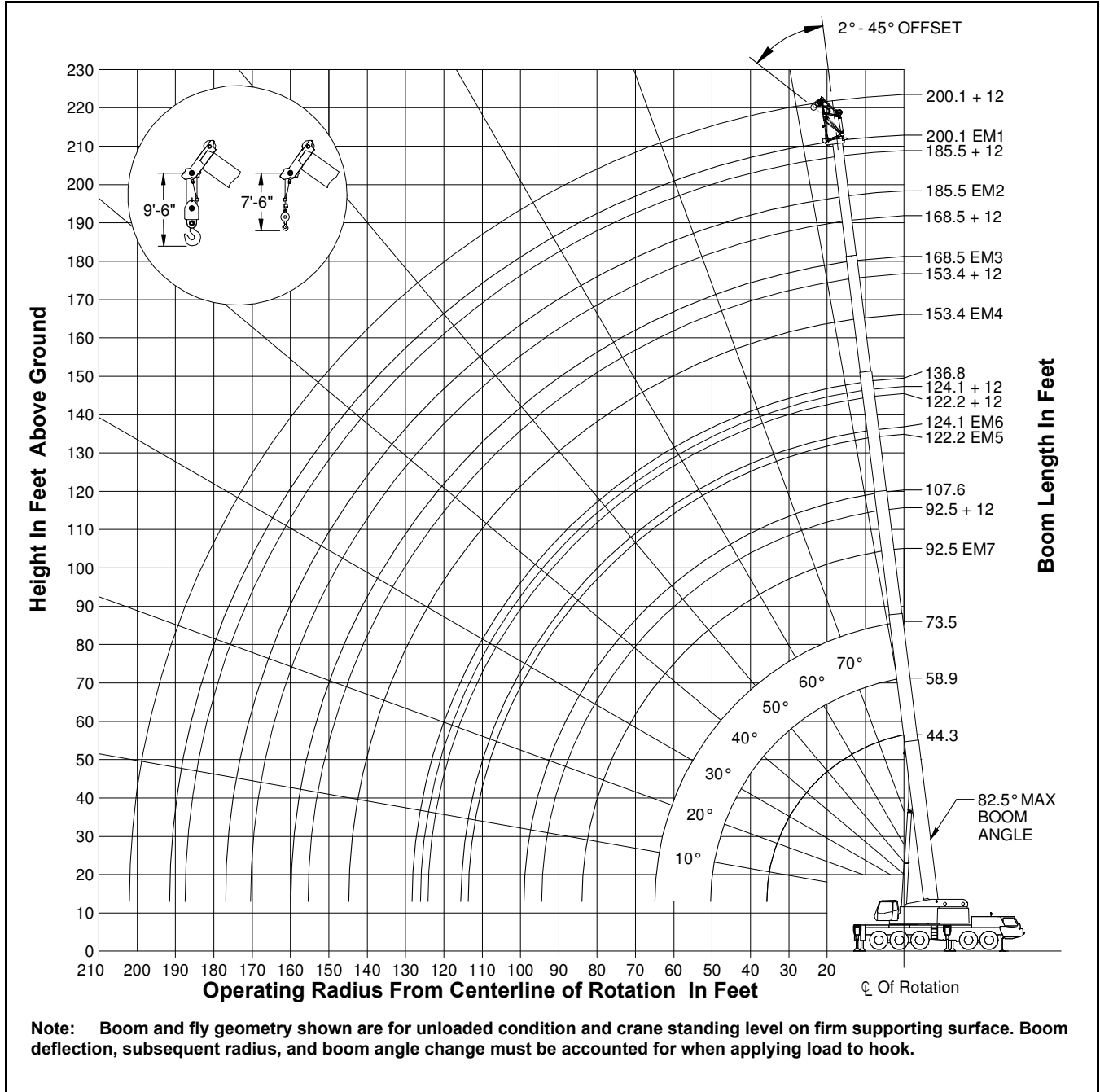

PORTLAND OFFICE: 503.283.3111
 SEATTLE OFFICE: 206.784.1054
WWW.NESSCAMPBELL.COM

Working Range Diagram Main Boom + Attachments

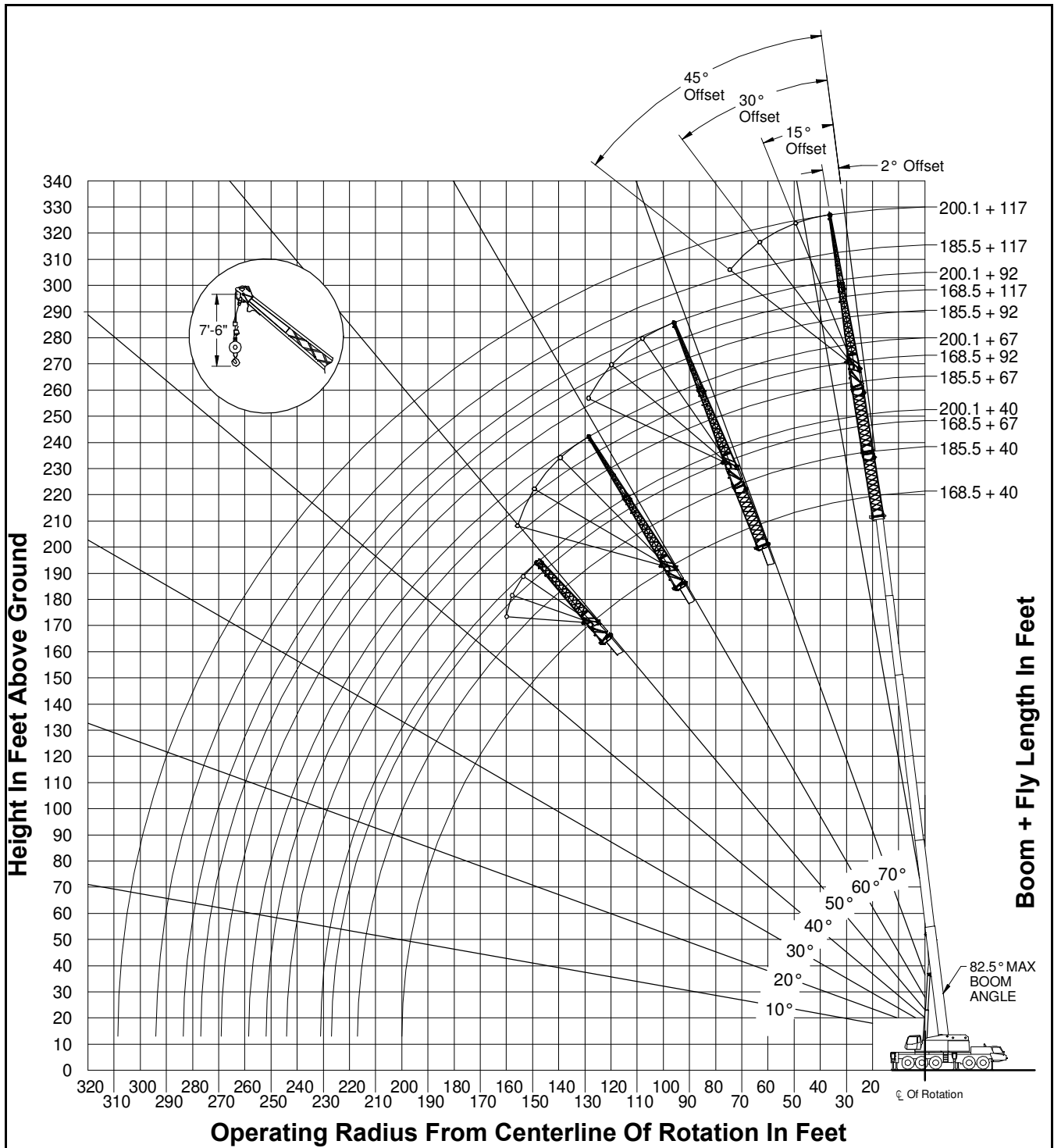

Note: Boom and fly geometry shown are for unloaded condition and crane standing level on firm supporting surface. Boom deflection, subsequent radius, and boom angle change must be accounted for when applying load to hook.



PORTLAND OFFICE: 503.283.3111
 SEATTLE OFFICE: 206.784.1054
WWW.NESSCAMPBELL.COM

Rated Lifting Capacities in Pounds

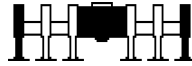

Full



0 lbs



Boom Length (ft)											
Extend Mode											
Radius (ft)	44.3	58.9	59.4	59.9	73.5	74.0	75.0	75.9	88.7	89.1	89.6
	ALL	EM2, EM5	EM6	EM7	EM1, EM3, EM4	EM5	EM6	EM7	EM4	EM2	EM5
10	276,600	195,200	278,200	277,400	134,800	196,100	247,000	262,200	125,300	120,100	168,700
12	244,100	182,900	247,500	246,100	125,600	182,200	228,300	245,100	117,000	112,200	168,700
15	195,400	167,200	199,400	198,000	114,000	164,700	200,100	197,700	106,200	102,000	161,600
20	144,300	146,500	148,500	147,300	98,600	141,800	149,700	147,500	91,900	88,500	140,000
25	86,100	94,600	92,800	90,500	86,700	98,000	94,700	90,600	80,800	78,000	98,700
30	55,200	63,000	61,400	59,500	67,100	65,800	63,100	59,700	68,700	67,700	66,400
35	37,900	45,500	44,200	42,500	49,200	48,100	45,600	42,600	50,700	49,800	48,600
40		34,300	33,100	31,500	37,800	36,800	34,700	31,900	39,200	38,300	37,300
45		26,400	25,200	23,700	30,100	29,100	27,000	24,400	31,400	30,600	29,600
50		20,600	19,400	18,000	24,300	23,400	21,400	18,900	25,600	24,800	23,900
55					19,700	18,900	17,000	14,600	21,200	20,400	19,500
60					16,200	15,400	13,500	11,200	17,600	17,000	16,200
65						12,500	10,600	8,400	14,800	14,100	13,300
70									12,400	11,700	10,900
75									10,400	9,700	8,900
80									8,700	8,000	7,200
Unpinned		101,200	89,600	80,400	55,600	95,600	89,600	72,800	98,200	56,000	83,900
Min Angle	0.0	0.0	0.0	0.0	0.0	0.0	0.0	0.0	0.0	0.0	0.0
Max Rad. Capacity	35.7	50.4	50.8	51.3	65.0	65.5	66.4	67.4	80.1	80.6	81.1
Capacity	35,800	20,200	18,600	16,800	12,200	12,300	9,900	7,200	8,700	7,900	6,900

1010010



PORTLAND OFFICE: 503.283.3111
 SEATTLE OFFICE: 206.784.1054
WWW.NESSCAMPBELL.COM

Rated Lifting Capacities in Pounds

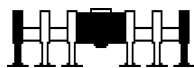

Full



0 lbs



Boom Length (ft)											
Extend Mode											
Radius (ft)	91.0	92.5	103.8	104.2	105.7	107.6	119.4	120.3	120.3	122.2	134.9
	EM6	EM7	EM1, EM3	EM4	EM5	EM6	EM3	EM4	EM2	EM5	EM1
10	212,200	203,700									
12	212,200	203,700									
15	198,500	195,600	84,300	100,600	128,900						
20	149,200	146,000	76,600	97,200	128,900	147,400	66,300	92,800	77,300	120,900	54,700
25	94,000	88,300	67,600	86,600	97,400	91,400	66,300	91,000	69,400	94,600	54,700
30	62,500	57,800	60,300	68,700	65,400	60,400	64,000	67,500	62,100	63,100	54,700
35	45,200	40,900	51,700	50,700	47,700	43,300	51,500	49,600	50,000	45,700	51,400
40	34,200	30,300	40,100	39,200	36,400	32,500	39,900	38,200	38,500	34,600	39,800
45	26,600	22,900	32,300	31,400	28,800	25,000	32,100	30,500	30,800	27,100	32,000
50	21,000	17,500	26,400	25,600	23,100	19,500	26,300	24,700	25,000	21,500	26,200
55	16,900	13,500	22,000	21,200	18,800	15,400	21,800	20,300	20,600	17,200	21,700
60	13,500	10,200	18,400	17,700	15,500	12,100	18,300	17,000	17,300	14,000	18,200
65	10,700	7,500	15,700	15,000	12,800	9,400	15,700	14,200	14,500	11,200	15,600
70	8,400	5,200	13,400	12,700	10,500	7,200	13,300	11,900	12,200	9,000	13,200
75	6,400	3,300	11,300	10,600	8,500	5,300	11,300	9,900	10,200	7,100	11,300
80	4,700		9,600	8,900	6,800	3,600	9,700	8,300	8,600	5,500	9,600
85			8,100	7,400	5,300	2,200	8,200	6,800	7,100	4,100	8,200
90			6,800	6,100	4,100		6,900	5,500	5,800	2,800	6,900
95			5,700	5,000	3,000		5,700	4,400	4,700		5,800
100							4,700	3,400	3,700		4,800
105							3,800	2,500	2,800		3,900
110							3,100				3,100
115											2,300
Unpinned	74,300	60,200	60,700	86,100	75,900	61,400	66,300	77,900	60,700	61,800	54,700
Min Angle	0.0	22.5	0.0	0.0	0.0	31.5	0.0	15.0	13.0	36.0	23.5
Max Rad.	82.5	78.4	95.2	95.7	97.1	85.8	110.8	108.6	110.0	93.6	117.5
Capacity	4,000	0	5,700	4,900	2,600	0	3,000	0	0	0	0

1010010



PORTLAND OFFICE: 503.283.3111
 SEATTLE OFFICE: 206.784.1054
WWW.NESSCAMPBELL.COM

Rated Lifting Capacities in Pounds

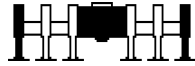

Full



0 lbs



Radius (ft)	Boom Length (ft)		
	Extend Mode		
	135.4	136.8	152.0
	EM3	EM4	EM3
20	65,600	91,400	
25	65,600	91,400	65,300
30	65,600	65,100	65,300
35	50,500	47,500	48,500
40	38,900	36,300	37,100
45	31,200	28,700	29,500
50	25,400	23,000	23,800
55	21,000	18,700	19,400
60	17,500	15,400	16,200
65	14,900	12,700	13,400
70	12,500	10,400	11,100
75	10,600	8,500	9,200
80	8,900	6,800	7,500
85	7,500	5,400	6,100
90	6,200	4,200	4,900
95	5,100	3,100	3,800
100	4,100	2,200	2,900
105	3,200		
110	2,400		
Unpinned	65,600	63,400	65,200
Min Angle	29.0	39.0	44.5
Max Rad.	112.9	101.1	105.0
Capacity	0	0	0

1010030



PORTLAND OFFICE: 503.283.3111
 SEATTLE OFFICE: 206.784.1054
WWW.NESSCAMPBELL.COM

Rated Lifting Capacities in Pounds

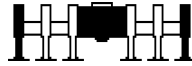

Full



14,000 lbs



Boom Length (ft)											
Extend Mode											
Radius (ft)	44.3	58.9	59.4	59.9	73.5	74.0	75.0	75.9	88.7	89.1	89.6
	ALL	EM2, EM5	EM6	EM7	EM1, EM3, EM4	EM5	EM6	EM7	EM4	EM2	EM5
10	279,600	195,200	281,100	280,300	134,800	196,100	247,000	262,200	125,300	120,100	168,700
12	250,700	182,900	252,700	251,800	125,600	182,200	228,300	250,900	117,000	112,200	168,700
15	205,200	167,200	209,000	207,800	114,000	164,700	205,000	207,400	106,200	102,000	161,600
20	151,800	146,500	156,000	154,800	98,600	141,800	157,100	154,900	91,900	88,500	140,000
25	111,000	119,500	117,700	115,400	86,700	122,800	119,600	115,500	80,800	78,000	123,300
30	72,900	80,600	79,100	77,200	75,900	83,500	80,700	77,300	72,100	69,600	84,000
35	51,600	59,200	57,800	56,100	62,900	61,800	59,300	56,300	64,300	62,800	62,200
40		45,500	44,200	42,700	49,100	48,100	45,800	43,000	50,400	49,600	48,500
45		35,800	34,700	33,200	39,500	38,500	36,400	33,900	40,700	39,900	38,900
50		28,800	27,700	26,300	32,500	31,600	29,600	27,100	33,800	33,000	32,100
55					27,000	26,100	24,200	21,800	28,400	27,700	26,700
60					22,600	21,800	19,900	17,600	24,100	23,400	22,500
65						18,300	16,500	14,200	20,600	19,900	19,000
70									17,700	17,100	16,200
75									15,300	14,600	13,800
80									13,200	12,600	11,700
Unpinned		101,200	89,600	80,400	55,600	95,600	89,600	72,800	98,200	56,000	83,900
Min Angle	0.0	0.0	0.0	0.0	0.0	0.0	0.0	0.0	0.0	0.0	0.0
Max Rad. Capacity	35.7	50.4	50.8	51.3	65.0	65.5	66.4	67.4	80.1	80.6	81.1
Capacity	49,100	22,600	26,700	24,700	12,200	18,100	15,600	12,800	10,700	12,400	11,400

1020010



PORTLAND OFFICE: 503.283.3111
 SEATTLE OFFICE: 206.784.1054
WWW.NESSCAMPBELL.COM

Rated Lifting Capacities in Pounds

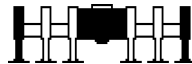

Full



14,000 lbs



		Boom Length (ft)										
		Extend Mode										
Radius (ft)	91.0	92.5	103.8	104.2	105.7	107.6	119.4	120.3	120.3	122.2	124.1	134.9
	EM6	EM7	EM1, EM3	EM4	EM5	EM6	EM3	EM4	EM2	EM5	EM6	EM1
10	212,200	203,700										
12	212,200	203,700										
15	198,500	203,700	84,300	100,600	128,900							
20	156,400	153,400	76,600	97,200	128,900	154,700	66,300	92,800	77,300	120,900	129,700	54,700
25	118,900	113,100	67,600	86,600	122,100	116,300	66,300	91,000	69,400	119,400	112,800	54,700
30	80,200	75,400	60,300	78,100	83,000	78,000	64,000	82,700	62,100	80,600	76,400	54,700
35	58,800	54,600	54,400	64,300	61,300	56,900	58,200	63,200	56,200	59,300	55,500	52,400
40	45,400	41,400	49,500	50,400	47,700	43,600	51,200	49,400	49,800	45,800	42,300	47,800
45	36,000	32,400	41,600	40,700	38,200	34,500	41,500	39,800	40,100	36,400	33,300	41,300
50	29,300	25,700	34,600	33,800	31,400	27,700	34,500	32,900	33,200	29,700	26,500	34,400
55	24,000	20,600	29,200	28,400	26,000	22,500	29,100	27,600	27,900	24,400	21,400	29,000
60	19,900	16,700	24,900	24,200	21,900	18,400	24,800	23,300	23,600	20,300	17,400	24,700
65	16,600	13,400	21,500	20,700	18,500	15,300	21,400	19,900	20,200	17,100	14,300	21,200
70	13,700	10,600	18,600	17,900	15,800	12,600	18,500	17,200	17,400	14,300	11,500	18,400
75	11,300	8,200	16,300	15,600	13,400	10,200	16,300	14,900	15,100	12,000	9,300	16,200
80	9,300	6,200	14,200	13,500	11,300	8,200	14,200	12,900	13,100	10,100	7,300	14,200
85			12,400	11,700	9,600	6,500	12,400	11,100	11,400	8,300	5,700	12,400
90			10,800	10,100	8,000	4,900	10,800	9,500	9,800	6,800	4,200	10,900
95			9,500	8,700	6,700	3,600	9,500	8,100	8,400	5,500	2,900	9,500
100							8,200	6,900	7,200	4,300		8,300
105							7,200	5,900	6,100	3,200		7,200
110							6,200	4,900	5,200			6,200
115												5,300
120												4,600
125												3,900
Unpinned	74,300	60,200	60,700	86,100	75,900	61,400	66,300	77,900	60,700	61,800	44,600	54,700
Min Angle	0.0	0.0	0.0	0.0	0.0	0.0	0.0	0.0	0.0	17.0	33.0	0.0
Max Rad.	82.5	83.9	95.2	95.7	97.1	99.0	110.8	111.7	111.8	110.0	98.8	126.4
Capacity	8,400	4,900	9,400	8,600	6,200	2,700	6,100	4,600	4,900	0	0	3,700

1020010



PORTLAND OFFICE: 503.283.3111
 SEATTLE OFFICE: 206.784.1054
WWW.NESSCAMPBELL.COM

Rated Lifting Capacities in Pounds

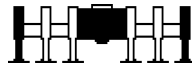

Full



14,000 lbs



		Boom Length (ft)							
		Extend Mode							
Radius (ft)	135.4	136.8	152.0	152.4	153.4	167.1	168.5	169.0	183.6
	EM3	EM4	EM3	EM2	EM4	EM1	EM3	EM2	EM1
20	65,600	91,400							
25	65,600	91,400	65,300	57,200	73,000	41,200			
30	65,600	82,700	65,300	57,200	73,000	41,200	55,000	53,300	38,700
35	61,700	61,100	62,000	54,500	59,400	41,200	55,000	53,300	38,700
40	50,200	47,500	48,400	48,300	46,000	41,200	46,900	46,800	38,700
45	40,500	38,000	38,800	38,700	36,600	39,800	37,400	37,300	38,400
50	33,600	31,200	32,000	31,900	29,900	33,000	30,700	30,600	31,700
55	28,200	25,900	26,700	26,600	24,600	27,600	25,400	25,300	26,300
60	24,000	21,700	22,500	22,400	20,500	23,300	21,200	21,200	22,100
65	20,500	18,300	19,100	19,000	17,100	19,900	17,900	17,800	18,700
70	17,700	15,700	16,500	16,400	14,600	17,100	15,300	15,300	16,200
75	15,500	13,400	14,100	14,000	12,200	15,000	13,000	12,900	13,800
80	13,500	11,400	12,100	12,000	10,300	12,900	11,000	10,900	11,800
85	11,700	9,700	10,400	10,300	8,600	11,200	9,300	9,200	10,100
90	10,200	8,200	8,900	8,800	7,100	9,700	7,800	7,700	8,600
95	8,900	6,900	7,500	7,500	5,800	8,300	6,500	6,400	7,300
100	7,600	5,700	6,400	6,300	4,600	7,200	5,300	5,300	6,100
105	6,600	4,600	5,300	5,300	3,600	6,100	4,300	4,200	5,100
110	5,600	3,600	4,400	4,300	2,700	5,200	3,400	3,300	4,100
115	4,700	2,800	3,500	3,400		4,300	2,500	2,500	3,300
120	3,900		2,700	2,600		3,600			2,500
125	3,200					2,800			
130						2,200			
Unpinned	65,600	63,400	65,200	57,200	63,200	41,200	55,000	53,300	38,700
Min Angle	0.0	22.5	31.5	32.5	39.5	36.0	44.0	44.5	47.0
Max Rad.	126.9	120.0	125.0	124.3	113.9	131.7	118.6	118.1	124.2
Capacity	3,000	0	0	0	0	0	0	0	0

1020010



PORTLAND OFFICE: 503.283.3111
 SEATTLE OFFICE: 206.784.1054
WWW.NESSCAMPBELL.COM

Rated Lifting Capacities in Pounds

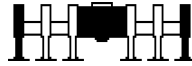

Full



36,000 lbs



Boom Length (ft)											
Extend Mode											
Radius (ft)	44.3	58.9	59.4	59.9	73.5	74.0	75.0	75.9	88.7	89.1	89.6
	ALL	EM2, EM5	EM6	EM7	EM1, EM3, EM4	EM5	EM6	EM7	EM4	EM2	EM5
10	284,500	195,200	285,800	284,900	134,800	196,100	247,000	262,200	125,300	120,100	168,700
12	255,100	182,900	257,000	256,100	125,600	182,200	228,300	255,100	117,000	112,200	168,700
15	220,100	167,200	222,600	221,600	114,000	164,700	205,000	221,100	106,200	102,000	161,600
20	163,600	146,500	167,700	166,500	98,600	141,800	168,800	166,500	91,900	88,500	140,000
25	128,100	130,500	132,400	131,100	86,700	124,400	133,600	131,400	80,800	78,000	123,300
30	100,800	108,400	106,800	104,900	75,900	110,800	108,400	105,000	72,100	69,600	110,000
35	73,200	80,800	79,400	77,700	67,200	83,300	80,800	77,800	65,000	62,800	83,700
40		63,100	61,800	60,300	60,000	65,600	63,400	60,600	59,100	57,100	66,000
45		50,700	49,600	48,100	54,100	53,400	51,300	48,700	54,100	51,700	53,700
50		41,700	40,600	39,100	45,300	44,400	42,400	39,900	46,600	45,800	44,900
55					38,300	37,400	35,500	33,200	39,700	38,900	38,000
60					32,800	32,000	30,100	27,800	34,300	33,600	32,700
65						27,500	25,700	23,400	29,800	29,100	28,200
70									26,100	25,400	24,500
75									23,000	22,300	21,500
80									20,400	19,700	18,900
Unpinned		101,200	89,600	80,400	55,600	95,600	89,600	72,800	98,200	56,000	83,900
Min Angle	0.0	0.0	0.0	0.0	0.0	0.0	0.0	0.0	0.0	0.0	0.0
Max Rad. Capacity	35.7	50.4	50.8	51.3	65.0	65.5	66.4	67.4	80.1	80.6	81.1
Capacity	66,600	22,600	39,300	37,200	12,200	19,400	24,600	21,600	10,700	16,400	16,100

1030010



PORTLAND OFFICE: 503.283.3111
 SEATTLE OFFICE: 206.784.1054
WWW.NESSCAMPBELL.COM

Rated Lifting Capacities in Pounds

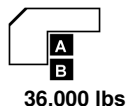
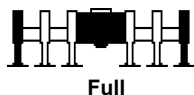

Radius (ft)	Boom Length (ft)											
	Extend Mode											
	91.0	92.5	103.8	104.2	105.7	107.6	119.4	120.3	120.3	122.2	124.1	134.9
	EM6	EM7	EM1, EM3	EM4	EM5	EM6	EM3	EM4	EM2	EM5	EM6	EM1
10	212,200	203,700										
12	212,200	203,700										
15	198,500	203,700	84,300	100,600	128,900							
20	168,100	164,900	76,600	97,200	128,900	166,100	66,300	92,800	77,300	120,900	129,700	54,700
25	133,200	130,100	67,600	86,600	124,700	131,700	66,300	91,000	69,400	120,900	112,800	54,700
30	107,800	103,100	60,300	78,100	110,500	105,600	64,000	82,700	62,100	108,200	99,400	54,700
35	80,300	76,100	54,400	71,000	82,800	78,400	58,200	75,900	56,200	80,700	76,900	52,400
40	62,900	59,000	49,500	65,000	65,200	61,100	53,300	66,900	51,200	63,300	59,800	47,800
45	50,900	47,200	45,300	55,500	52,900	49,300	48,900	54,500	46,900	51,300	48,000	43,800
50	42,100	38,500	41,700	46,600	44,100	40,500	45,100	45,700	43,200	42,400	39,300	40,400
55	35,300	32,000	38,700	39,700	37,300	33,900	40,300	38,800	39,100	35,600	32,800	37,400
60	30,100	26,800	35,000	34,300	32,100	28,600	34,800	33,500	33,800	30,500	27,500	34,700
65	25,700	22,500	30,700	29,900	27,700	24,400	30,600	29,100	29,400	26,200	23,300	30,500
70	22,000	18,900	27,000	26,300	24,100	20,800	26,900	25,500	25,800	22,600	19,800	26,800
75	19,000	16,000	23,900	23,200	21,000	17,800	23,900	22,500	22,700	19,600	17,000	23,700
80	16,400	13,400	21,200	20,500	18,400	15,400	21,200	19,900	20,100	17,200	14,500	21,100
85			18,900	18,200	16,200	13,100	19,000	17,600	17,900	15,000	12,300	18,900
90			17,000	16,300	14,300	11,200	17,100	15,700	16,000	13,000	10,400	17,100
95			15,300	14,600	12,500	9,500	15,300	14,000	14,300	11,300	8,700	15,400
100							13,800	12,500	12,700	9,800	7,200	13,800
105							12,400	11,100	11,300	8,400	5,900	12,400
110							11,200	9,900	10,100	7,200	4,700	11,200
115											3,600	10,000
120												9,000
125												8,100
Unpinned	74,300	60,200	60,700	86,100	75,900	61,400	66,300	77,900	60,700	61,800	44,600	54,700
Min Angle	0.0	0.0	0.0	0.0	0.0	0.0	0.0	0.0	0.0	0.0	0.0	0.0
Max Rad.	82.5	83.9	95.2	95.7	97.1	99.0	110.8	111.7	111.8	113.7	115.6	126.4
Capacity	15,300	11,600	9,400	9,100	11,900	8,300	7,900	7,300	9,800	6,400	3,500	6,700

1030010



PORTLAND OFFICE: 503.283.3111
 SEATTLE OFFICE: 206.784.1054
WWW.NESSCAMPBELL.COM

Rated Lifting Capacities in Pounds

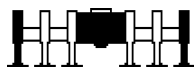

Full



36,000 lbs



Boom Length (ft)											
Extend Mode											
Radius (ft)	135.4	136.8	152.0	152.4	153.4	167.1	168.5	169.0	183.6	185.5	200.1
	EM3	EM4	EM3	EM2	EM4	EM1	EM3	EM2	EM1	EM2	EM1
20	65,600	91,400									
25	65,600	91,400	65,300	57,200	73,000	41,200					
30	65,600	85,500	65,300	57,200	73,000	41,200	55,000	53,300	38,700	41,300	
35	61,700	79,100	64,100	54,500	73,000	41,200	55,000	53,300	38,700	41,300	33,000
40	57,000	65,000	59,600	49,800	63,400	41,200	55,000	52,200	38,700	41,300	33,000
45	52,800	52,700	53,500	45,700	51,500	41,200	52,100	48,200	38,700	41,300	33,000
50	46,400	43,900	44,700	41,900	42,600	40,500	43,400	43,300	38,700	41,300	33,000
55	39,400	37,100	37,800	37,800	35,800	37,600	36,500	36,500	37,400	35,400	33,000
60	34,200	31,900	32,700	32,600	30,700	33,500	31,400	31,400	32,300	30,300	31,300
65	29,800	27,600	28,300	28,200	26,300	29,100	27,100	27,000	27,900	26,000	26,900
70	26,100	24,000	24,700	24,600	22,800	25,500	23,500	23,400	24,300	22,400	23,400
75	23,100	20,900	21,600	21,600	19,800	22,500	20,500	20,400	21,300	19,500	20,300
80	20,500	18,400	19,100	19,000	17,200	19,900	17,900	17,800	18,700	17,200	17,800
85	18,200	16,400	17,000	17,000	15,200	17,600	15,900	15,900	16,800	15,000	15,900
90	16,400	14,400	15,100	15,000	13,300	15,900	14,000	14,000	14,800	13,100	13,900
95	14,700	12,700	13,400	13,300	11,600	14,200	12,300	12,300	13,100	11,400	12,200
100	13,200	11,200	11,900	11,800	10,100	12,700	10,800	10,800	11,600	9,900	10,800
105	11,800	9,800	10,600	10,500	8,800	11,300	9,500	9,400	10,300	8,600	9,400
110	10,500	8,600	9,300	9,300	7,600	10,100	8,300	8,200	9,100	7,400	8,200
115	9,400	7,500	8,200	8,100	6,500	9,100	7,200	7,200	8,000	6,300	7,200
120	8,400	6,500	7,200	7,100	5,500	8,000	6,200	6,200	7,000	5,400	6,200
125	7,500	5,600	6,300	6,200	4,600	7,100	5,300	5,300	6,100	4,500	5,300
130			5,500	5,400	3,800	6,300	4,500	4,400	5,300	3,700	4,500
135			4,700	4,600	3,000	5,500	3,700	3,700	4,600	2,900	3,700
140			4,000	3,900		4,800	3,000	3,000	3,800	2,200	3,000
145						4,100	2,400	2,300	3,200		2,400
150						3,600			2,600		
155						3,000					
Unpinned	65,600	63,400	65,200	57,200	63,200	41,200	55,000	53,300	38,700	41,300	33,000
Min Angle	0.0	0.0	0.0	0.0	17.5	0.0	24.5	25.5	30.5	39.5	42.5
Max Rad.	126.9	128.3	143.4	143.9	140.0	158.5	148.3	147.5	155.0	141.7	148.3
Capacity	6,400	5,100	3,600	3,500	0	2,700	0	0	0	0	0

1030010



PORTLAND OFFICE: 503.283.3111
 SEATTLE OFFICE: 206.784.1054
WWW.NESSCAMPBELL.COM

Rated Lifting Capacities in Pounds

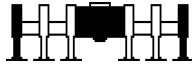

Full

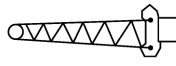

12ft Offset Fly
2° - 45°



36,000 lbs



360°

Boom Length (ft)											
Extend Mode											
Radius (ft)	44.3	58.9	59.4	59.9	73.5	74.0	75.0	75.9	88.7	89.1	89.6
	ALL	EM2, EM5	EM6	EM7	EM1, EM3, EM4	EM5	EM6	EM7	EM4	EM2	EM5
10	69,600	69,500	69,500	69,500	69,400	69,400	69,400	69,400	69,400	69,400	69,300
12	69,600	69,500	69,500	69,500	69,400	69,400	69,400	69,400	69,400	69,400	69,300
15	69,600	69,500	69,500	69,500	69,400	69,400	69,400	69,400	69,400	69,400	69,300
20	69,600	69,500	69,500	69,500	69,400	69,400	69,400	69,400	69,400	69,400	69,300
25	69,600	69,500	69,500	69,500	69,400	69,400	69,400	69,400	69,400	69,400	69,300
30	66,700	69,500	69,500	69,500	64,100	69,400	69,400	69,400	63,700	62,300	69,300
35	61,800	69,400	69,500	69,500	57,500	69,400	69,400	69,400	57,200	56,000	69,300
40	57,700	64,900	63,700	62,300	51,300	66,100	64,000	61,400	51,900	50,700	65,900
45	49,700	52,600	51,700	50,400	46,300	53,800	51,900	49,500	47,400	46,300	53,600
50		43,800	42,800	41,500	42,600	44,900	43,000	40,700	43,900	42,600	44,700
55		37,000	36,100	34,900	38,800	38,000	36,200	34,100	39,400	38,700	37,800
60		31,800	30,900	29,700	33,500	32,700	31,000	28,900	34,100	33,400	32,600
65					29,100	28,400	26,700	24,600	29,600	29,000	28,200
70					25,500	24,800	23,100	21,100	26,000	25,400	24,600
75					22,600	21,900	20,200	18,200	23,000	22,400	21,600
80									20,400	19,800	19,000
85									18,200	17,600	16,900
90									16,400	15,800	15,100
Unpinned		69,500	69,500	69,500	55,600	69,400	69,400	69,400	69,400	56,000	69,300
Min Angle	0.0	0.0	0.0	0.0	0.0	0.0	0.0	0.0	0.0	0.0	0.0
Max Rad.	46.4	61.0	61.5	61.9	75.6	76.1	77.0	78.0	90.7	91.2	91.7
Capacity	30,500	14,600	25,100	24,400	7,900	12,500	19,300	16,800	6,800	10,700	10,400

1033010



PORTLAND OFFICE: 503.283.3111
 SEATTLE OFFICE: 206.784.1054
WWW.NESSCAMPBELL.COM

Rated Lifting Capacities in Pounds

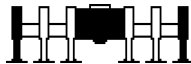

Full

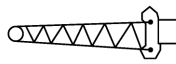

12ft Offset Fly
2° - 45°



36,000 lbs



360°

		Boom Length (ft)										
		Extend Mode										
Radius (ft)	91.0	92.5	103.8	104.2	105.7	107.6	119.4	120.3	120.3	122.2	124.1	134.9
	EM6	EM7	EM1, EM3	EM4	EM5	EM6	EM3	EM4	EM2	EM5	EM6	EM1
10	69,300	69,300										
12	69,300	69,300										
15	69,300	69,300	62,700	69,300	69,300	69,200	54,600	69,200	61,000	69,200	69,100	
20	69,300	69,300	62,700	69,300	69,300	69,200	54,600	69,200	61,000	69,200	69,100	42,600
25	69,300	69,300	61,800	69,300	69,300	69,200	54,600	69,200	61,000	69,200	69,100	42,600
30	69,300	69,300	55,000	68,300	69,300	69,200	54,600	69,200	58,300	69,200	69,100	42,600
35	69,300	69,300	49,400	62,100	69,300	69,200	52,600	66,100	52,500	69,200	69,100	42,600
40	63,000	59,300	45,000	56,700	64,700	60,800	48,000	60,800	47,700	62,600	59,200	42,600
45	51,000	47,500	41,100	52,100	52,500	49,000	44,300	53,700	43,700	50,700	47,500	41,000
50	42,100	38,800	37,700	46,000	43,700	40,200	40,900	44,900	40,100	41,800	38,800	37,700
55	35,300	32,300	34,800	39,000	36,800	33,700	37,900	38,000	37,000	35,000	32,300	34,800
60	30,100	27,100	32,200	33,700	31,600	28,400	34,100	32,700	33,000	29,900	27,100	32,200
65	25,800	22,800	30,000	29,300	27,200	24,100	29,700	28,300	28,600	25,500	22,800	29,400
70	22,300	19,400	26,400	25,700	23,600	20,600	26,100	24,700	25,000	22,000	19,300	25,800
75	19,300	16,600	23,300	22,600	20,600	17,600	23,000	21,700	21,900	19,000	16,600	22,700
80	16,900	14,100	20,700	20,100	18,100	15,300	20,400	19,100	19,300	16,600	14,100	20,100
85	14,700	11,900	18,500	17,800	16,000	13,100	18,200	17,000	17,300	14,400	11,900	17,900
90	12,800	10,100	16,700	16,000	14,100	11,200	16,400	15,100	15,300	12,500	10,000	16,100
95			15,000	14,300	12,400	9,600	14,600	13,400	13,600	10,900	8,400	14,400
100			13,500	12,800	11,000	8,100	13,100	11,900	12,100	9,400	7,000	12,900
105			12,200	11,600	9,700	6,900	11,800	10,600	10,800	8,100	5,700	11,500
110							10,600	9,400	9,600	6,900	4,500	10,300
115							9,500	8,300	8,600	5,900	3,500	9,300
120							8,600	7,400	7,600	4,900	2,600	8,300
125												7,400
130												6,600
135												5,900
Unpinned	69,300	60,200	60,700	69,300	69,300	61,400	54,600	69,200	60,700	61,800	44,600	42,600
Min Angle	0.0	0.0	0.0	0.0	0.0	0.0	0.0	0.0	0.0	0.0	13.0	0.0
Max Rad.	93.1	94.5	105.8	106.3	107.7	109.7	121.4	122.4	122.4	124.3	123.3	137.0
Capacity	11,900	8,700	5,900	5,600	8,100	5,900	4,800	4,200	7,200	4,300	0	3,800

1033010



PORTLAND OFFICE: 503.283.3111
SEATTLE OFFICE: 206.784.1054
WWW.NESSCAMPBELL.COM

Rated Lifting Capacities in Pounds

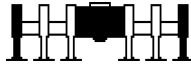

Full

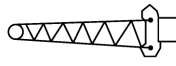

12ft Offset Fly
2° - 45°



36,000 lbs



360°

Boom Length (ft)											
Extend Mode											
Radius (ft)	135.4	136.8	152.0	152.4	153.4	167.1	168.5	169.0	183.6	185.5	200.1
	EM3	EM4	EM3	EM2	EM4	EM1	EM3	EM2	EM1	EM2	EM1
25	55,600	69,100	55,000	49,300	59,000	35,100	43,000	42,100			
30	55,600	69,100	55,000	49,100	59,000	35,100	43,000	42,100	32,900	35,400	
35	55,600	68,900	55,000	49,100	59,000	35,100	43,000	42,100	32,900	35,400	28,100
40	51,100	63,800	53,400	47,200	59,000	35,100	43,000	42,100	32,900	35,400	28,100
45	47,200	51,700	49,600	43,200	50,400	35,100	43,000	42,100	32,900	35,400	28,100
50	43,900	43,000	43,600	39,700	41,500	35,100	42,200	41,800	32,900	35,400	28,100
55	38,400	36,200	36,700	36,600	34,700	35,100	35,300	35,300	32,900	34,100	28,100
60	33,200	31,000	31,600	31,500	29,600	32,300	30,300	30,200	31,000	29,100	28,100
65	28,800	26,700	27,200	27,100	25,300	27,900	25,900	25,800	26,700	24,800	25,600
70	25,100	23,100	23,600	23,500	21,800	24,300	22,300	22,300	23,100	21,200	22,000
75	22,100	20,100	20,600	20,500	18,800	21,200	19,300	19,300	20,000	18,200	19,000
80	19,500	17,500	18,000	17,900	16,500	18,700	17,000	17,000	17,500	16,000	16,800
85	17,300	15,500	16,000	15,900	14,300	16,700	14,800	14,800	15,500	13,800	14,600
90	15,500	13,600	14,100	14,000	12,400	14,700	12,900	12,900	13,600	11,900	12,700
95	13,800	11,900	12,400	12,300	10,700	13,000	11,200	11,200	11,900	10,200	11,000
100	12,300	10,400	10,900	10,800	9,200	11,500	9,800	9,700	10,400	8,800	9,500
105	10,900	9,100	9,600	9,500	7,900	10,200	8,400	8,400	9,100	7,400	8,200
110	9,700	7,900	8,400	8,300	6,700	9,000	7,200	7,200	7,900	6,300	7,000
115	8,700	6,800	7,300	7,200	5,700	7,900	6,200	6,100	6,800	5,200	5,900
120	7,700	5,900	6,300	6,300	4,700	6,900	5,200	5,100	5,900	4,200	4,900
125	6,800	5,000	5,400	5,400	3,800	6,000	4,300	4,300	5,000	3,400	4,100
130	6,000	4,200	4,600	4,600	3,000	5,200	3,500	3,500	4,200	2,600	3,300
135	5,300	3,500	3,900	3,800	2,300	4,500	2,800	2,700	3,400		2,500
140			3,200	3,200		3,800	2,100	2,100	2,700		
145			2,600	2,500		3,200			2,100		
150						2,600					
155						2,100					
Unpinned	55,600	63,400	55,000	49,300	59,000	35,100	43,000	42,100	32,900	35,400	28,100
Min Angle	0.0	0.0	15.0	16.5	30.0	25.5	36.5	36.5	40.5	47.0	49.5
Max Rad.	137.5	138.9	150.0	150.0	137.1	156.0	140.8	140.7	145.8	133.8	138.6
Capacity	3,500	2,600	0	0	0	0	0	0	0	0	0

1033010



PORTLAND OFFICE: 503.283.3111
 SEATTLE OFFICE: 206.784.1054
WWW.NESSCAMPBELL.COM

Rated Lifting Capacities in Pounds

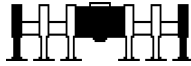

Full

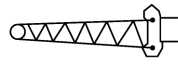

40ft Offset Fly



36,000 lbs



Radius (ft)	Boom Length (ft)											
	Fly Offset											
	44.3				73.5				103.8			
	2°	15°	30°	45°	2°	15°	30°	45°	2°	15°	30°	45°
10	34,700											
12	34,700				34,600							
15	34,700	34,700			34,600							
20	34,700	32,000			34,600	34,600			34,500			
25	33,900	28,800	24,900		34,600	32,900			34,500			
30	30,200	26,200	22,900	20,200	34,600	30,300	25,100		34,500	33,500		
35	27,200	24,000	20,700	19,000	34,500	28,100	23,600	20,300	34,500	31,400	25,200	
40	24,800	21,400	19,400	18,000	31,600	26,200	21,700	19,500	34,500	29,500	24,000	20,400
45	21,900	19,900	18,200	17,200	29,100	24,600	20,700	18,700	34,500	27,800	23,000	19,700
50	20,200	18,600	17,300	16,400	27,000	23,100	19,700	18,000	32,500	26,300	21,500	19,100
55	18,800	17,500	16,400	15,800	25,100	21,200	18,900	17,400	30,400	25,000	20,700	18,500
60	17,500	16,500	15,700	15,300	23,500	20,100	18,100	16,900	28,600	23,800	20,000	18,000
65	16,400	15,600	15,000	14,900	21,400	19,200	17,400	16,400	26,700	22,700	19,300	17,500
70	15,400	14,900	14,600		20,200	18,300	16,800	15,900	24,800	21,200	18,600	17,100
75	14,500	14,300			19,200	17,500	16,200	15,600	23,200	20,400	18,000	16,700
80					18,200	16,800	15,700	15,300	22,000	19,600	17,500	16,400
85					17,300	16,100	15,300	15,000	20,200	18,800	17,000	16,000
90					16,500	15,500	14,900		18,200	18,200	16,600	15,700
95					15,700	15,000	14,600		16,600	17,200	16,200	15,500
100					15,100	14,600			15,100	15,600	15,800	15,300
105					9,500				13,700	14,200	14,600	14,800
110									12,500	12,900	13,200	13,300
115									11,300	11,700	12,000	
120									10,300	10,600	10,800	
125									9,400	9,700	9,800	
130									8,600	8,800		
135									7,900			
Min Angle	0.0	0.0	0.0	0.0	0.0	0.0	0.0	0.0	0.0	0.0	0.0	0.0
Max Rad.	75.9	75.8	74.5	71.9	105.1	104.9	103.2	100.0	135.3	135.1	133.1	129.6
Capacity	11,200	11,400	12,100	13,600	3,700	3,700	3,900	4,200	2,600	2,600	2,700	2,900

1031040



PORTLAND OFFICE: 503.283.3111
 SEATTLE OFFICE: 206.784.1054
WWW.NESSCAMPBELL.COM

Rated Lifting Capacities in Pounds

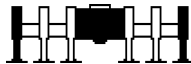

Full

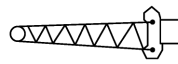

40ft Offset Fly



36,000 lbs



Radius (ft)	Boom Length (ft)											
	Fly Offset											
	134.9				167.1				183.6			
	2°	15°	30°	45°	2°	15°	30°	45°	2°	15°	30°	45°
25	29,700											
30	29,700				19,800							
35	29,700	29,500			19,800				18,600			
40	29,700	29,500			19,800	19,700			18,600			
45	29,700	29,500	24,300		19,800	19,700			18,600	18,500		
50	29,700	29,000	23,400	19,900	19,800	19,700	19,600		18,600	18,500		
55	29,700	27,700	22,100	19,300	19,800	19,700	19,600		18,600	18,500	18,300	
60	29,700	26,400	21,400	18,900	19,800	19,700	19,600	19,300	18,600	18,500	18,300	18,000
65	27,800	25,300	20,700	18,400	19,800	19,700	19,600	19,100	18,600	18,500	18,300	18,000
70	25,800	24,300	20,100	18,000	19,800	19,700	19,600	18,700	18,600	18,500	18,300	18,000
75	24,100	23,400	19,600	17,600	19,800	19,700	19,600	18,400	18,600	18,500	18,300	18,000
80	21,500	22,000	19,000	17,300	19,800	19,700	19,600	18,000	18,600	18,500	18,300	18,000
85	19,200	20,100	18,500	17,000	17,500	18,600	19,600	17,700	16,700	17,500	18,300	18,000
90	17,200	18,000	18,000	16,600	15,900	16,800	17,500	17,400	14,700	15,800	16,900	17,400
95	15,700	16,400	17,100	16,400	14,100	15,000	15,900	16,600	13,000	14,000	15,000	15,800
100	14,100	14,800	15,500	15,900	12,600	13,400	14,200	14,900	11,500	12,400	13,300	14,000
105	12,700	13,400	14,000	14,400	11,200	12,000	12,700	13,300	10,100	10,900	11,800	12,400
110	11,500	12,100	12,600	13,000	10,000	10,700	11,400	11,900	8,900	9,700	10,500	11,000
115	10,400	10,900	11,400	11,700	8,900	9,500	10,200	10,600	7,800	8,500	9,200	9,800
120	9,400	9,800	10,300	10,500	7,900	8,500	9,100	9,500	6,800	7,500	8,100	8,600
125	8,500	8,900	9,300	9,500	7,000	7,500	8,100	8,400	5,900	6,500	7,100	7,600
130	7,600	8,000	8,300	8,500	6,100	6,600	7,100	7,500	5,000	5,600	6,200	6,600
135	6,800	7,200	7,500	7,600	5,400	5,800	6,300	6,600	4,300	4,800	5,400	5,700
140	6,100	6,400	6,700		4,600	5,100	5,500	5,700	3,600	4,100	4,600	4,900
145	5,500	5,800	5,900		4,000	4,400	4,800	5,000	2,900	3,400	3,900	4,100
150	4,900	5,100	5,200		3,400	3,800	4,100	4,300	2,300	2,800	3,200	3,400
155	4,300	4,500	4,600		2,800	3,200	3,500	3,600		2,200	2,600	2,800
160	3,800	4,000			2,300	2,600	2,900	3,000				2,200
165						2,100	2,400					
Min Angle	11.5	13.0	21.5	4.5	38.0	38.5	38.5	38.0	48.0	48.0	48.5	48.5
Max Rad.	165.0	165.0	160.0	158.4	163.0	166.3	168.3	169.0	153.0	157.0	160.0	161.7
Capacity	0	0	0	0	0	0	0	0	0	0	0	0

1031040



PORTLAND OFFICE: 503.283.3111
 SEATTLE OFFICE: 206.784.1054
WWW.NESSCAMPBELL.COM

Rated Lifting Capacities in Pounds

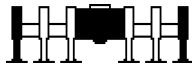

Full

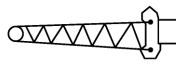

40ft Offset Fly



36,000 lbs



Radius (ft)	Boom Length (ft)			
	Fly Offset			
	200.1			
	2°	15°	30°	45°
40	16,100			
45	16,100			
50	16,100	16,100		
55	16,100	16,100		
60	16,100	16,100	15,900	
65	16,100	16,100	15,900	15,600
70	16,100	16,100	15,900	15,600
75	16,100	16,100	15,900	15,600
80	16,100	16,100	15,900	15,600
85	15,700	16,100	15,900	15,600
90	13,700	14,900	15,900	15,600
95	12,000	13,100	14,200	15,000
100	10,500	11,500	12,500	13,300
105	9,100	10,100	11,000	11,700
110	7,900	8,800	9,600	10,300
115	6,800	7,600	8,400	9,000
120	5,800	6,600	7,300	7,900
125	4,900	5,600	6,300	6,800
130	4,100	4,800	5,400	5,900
135	3,300	4,000	4,600	5,000
140	2,600	3,200	3,800	4,200
145		2,600	3,100	3,400
150			2,400	2,700
155				2,100
Min Angle	54.5	55.0	55.0	55.5
Max Rad.	145.0	149.3	153.3	155.7
Capacity	0	0	0	0

1031040



PORTLAND OFFICE: 503.283.3111
 SEATTLE OFFICE: 206.784.1054
WWW.NESSCAMPBELL.COM

Rated Lifting Capacities in Pounds

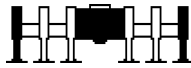

Full

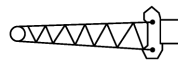

40ft Offset Fly



36,000 lbs



Radius (ft)	Boom Length (ft)											
	Fly Offset											
	44.3				58.9				89.1			
	2°	15°	30°	45°	2°	15°	30°	45°	2°	15°	30°	45°
10	34,700				34,700							
12	34,700				34,700							
15	34,700	34,700			34,700				34,600			
20	34,700	32,000			34,700	34,200			34,600			
25	33,900	28,800	24,900		34,700	31,100	25,900		34,600	34,600		
30	30,200	26,200	22,900	20,200	34,200	28,400	24,100		34,600	32,100	25,900	
35	27,200	24,000	20,700	19,000	31,000	26,200	21,900	19,800	34,600	29,900	24,500	
40	24,800	21,400	19,400	18,000	28,300	24,300	20,700	18,800	34,600	28,000	23,300	20,000
45	21,900	19,900	18,200	17,200	26,000	22,000	19,600	18,000	32,200	26,300	21,700	19,300
50	20,200	18,600	17,300	16,400	24,000	20,600	18,600	17,300	29,900	24,900	20,700	18,600
55	18,800	17,500	16,400	15,800	21,600	19,500	17,800	16,700	27,900	23,600	19,900	18,000
60	17,500	16,500	15,700	15,300	20,200	18,400	17,000	16,100	26,200	21,800	19,100	17,500
65	16,400	15,600	15,000	14,900	19,000	17,500	16,300	15,700	24,600	20,800	18,400	17,000
70	15,400	14,900	14,600		17,900	16,700	15,700	15,300	23,300	19,900	17,800	16,600
75	14,500	14,300			16,900	15,900	15,200	15,000	21,400	19,000	17,200	16,200
80					16,000	15,300	14,800		20,400	18,300	16,700	15,800
85					15,200	14,700	14,500		19,400	17,600	16,200	15,500
90					14,500				17,900	16,900	15,800	15,300
95									16,300	16,400	15,400	15,100
100									14,700	15,200	15,100	14,900
105									13,300	13,700	14,000	
110									12,100	12,400	12,600	
115									11,000	11,200		
120									10,100			
Min Angle	0.0	0.0	0.0	0.0	0.0	0.0	0.0	0.0	0.0	0.0	0.0	0.0
Max Rad. Capacity	75.9	75.8	74.5	71.9	90.5	90.4	88.8	85.9	120.7	120.5	118.6	115.2
Capacity	11,200	11,400	12,100	13,600	6,600	6,700	7,000	7,700	4,900	5,000	5,200	5,700

1031050



PORTLAND OFFICE: 503.283.3111
 SEATTLE OFFICE: 206.784.1054
WWW.NESSCAMPBELL.COM

Rated Lifting Capacities in Pounds

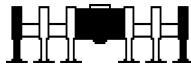

Full

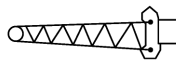

40ft Offset Fly



36,000 lbs



Radius (ft)	Boom Length (ft)											
	Fly Offset											
	120.3				152.4				169.0			
	2°	15°	30°	45°	2°	15°	30°	45°	2°	15°	30°	45°
25	34,500											
30	34,500				31,300							
35	34,500	32,800			31,300							
40	34,500	30,900			31,300				29,200			
45	34,500	29,300	23,700		31,300	31,200			29,200			
50	34,500	27,800	22,800	19,500	31,300	30,300	24,000		29,200	29,100		
55	33,100	26,500	21,500	19,000	31,300	28,900	23,200		29,200	29,100	23,800	
60	31,200	25,300	20,800	18,500	31,300	27,700	22,000	19,300	29,200	28,800	23,100	
65	29,300	24,200	20,100	18,000	28,800	26,600	21,400	18,800	27,500	27,700	22,000	19,200
70	26,900	23,200	19,500	17,600	25,100	25,600	20,800	18,400	23,800	25,400	21,400	18,800
75	23,800	21,700	18,900	17,200	22,000	23,300	20,200	18,100	20,800	22,200	20,800	18,400
80	21,100	20,900	18,300	16,900	19,400	20,600	19,700	17,700	18,200	19,400	20,300	18,100
85	18,800	19,700	17,900	16,500	17,100	18,200	19,200	17,400	16,200	17,100	18,300	17,800
90	17,000	17,600	17,400	16,200	15,400	16,400	17,100	17,100	14,200	15,300	16,400	17,000
95	15,300	16,000	16,700	16,000	13,700	14,600	15,500	16,200	12,500	13,500	14,500	15,300
100	13,700	14,400	15,000	15,400	12,200	13,000	13,800	14,400	11,000	11,900	12,800	13,500
105	12,400	13,000	13,500	13,900	10,800	11,600	12,300	12,800	9,600	10,500	11,300	12,000
110	11,100	11,700	12,200	12,400	9,600	10,300	10,900	11,400	8,400	9,200	10,000	10,600
115	10,000	10,500	10,900	11,200	8,500	9,100	9,700	10,100	7,300	8,100	8,800	9,300
120	9,000	9,400	9,800	10,000	7,500	8,100	8,600	9,000	6,300	7,000	7,700	8,100
125	8,100	8,500	8,800		6,500	7,100	7,600	7,900	5,400	6,100	6,700	7,100
130	7,300	7,600	7,800		5,700	6,200	6,700	7,000	4,600	5,200	5,700	6,100
135	6,500	6,800	7,000		5,000	5,400	5,800	6,100	3,800	4,400	4,900	5,200
140	5,800	6,000	6,100		4,300	4,700	5,000	5,200	3,100	3,600	4,100	4,400
145	5,200	5,300			3,600	4,000	4,300	4,500	2,500	3,000	3,400	3,600
150	4,600	4,700			3,000	3,400	3,600			2,300	2,700	2,900
155					2,500	2,800	3,000				2,100	2,200
160						2,200	2,400					
Min Angle	0.0	0.0	0.0	0.0	33.0	33.0	33.5	33.0	45.0	45.0	45.0	45.0
Max Rad.	151.9	151.6	149.6	145.9	159.2	162.0	163.3	163.3	149.2	152.5	155.8	156.7
Capacity	3,200	3,200	3,400	3,700	0	0	0	0	0	0	0	0

1031050



PORTLAND OFFICE: 503.283.3111
 SEATTLE OFFICE: 206.784.1054
WWW.NESSCAMPBELL.COM

Rated Lifting Capacities in Pounds

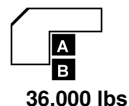
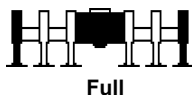

Radius (ft)	Boom Length (ft)			
	Fly Offset			
	185.5			
	2°	15°	30°	45°
40	20,200			
45	20,200			
50	20,200	20,100		
55	20,200	20,100		
60	20,200	20,100	19,900	
65	20,200	20,100	19,900	
70	20,200	20,100	19,900	19,100
75	19,700	20,100	19,900	18,700
80	17,100	18,500	19,900	18,400
85	15,200	16,400	17,400	18,100
90	13,200	14,400	15,600	16,500
95	11,500	12,600	13,700	14,500
100	10,000	11,000	12,000	12,800
105	8,600	9,600	10,500	11,200
110	7,400	8,300	9,200	9,800
115	6,300	7,200	8,000	8,500
120	5,400	6,100	6,900	7,400
125	4,500	5,200	5,900	6,300
130	3,600	4,300	4,900	5,400
135	2,900	3,500	4,100	4,500
140	2,200	2,800	3,300	3,700
145		2,100	2,600	2,900
150				2,200
Min Angle	52.5	52.5	53.0	53.0
Max Rad.	141.4	145.8	149.3	151.4
Capacity	0	0	0	0

1031050



PORTLAND OFFICE: 503.283.3111
 SEATTLE OFFICE: 206.784.1054
WWW.NESSCAMPBELL.COM

Rated Lifting Capacities in Pounds

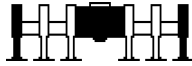

Full

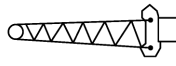

40ft Offset Fly



36,000 lbs



Radius (ft)	Boom Length (ft)											
	Fly Offset											
	44.3				73.5				103.8			
	2°	15°	30°	45°	2°	15°	30°	45°	2°	15°	30°	45°
10	34,700											
12	34,700				34,600							
15	34,700	34,700			34,600							
20	34,700	32,000			34,600	34,600			34,500			
25	33,900	28,800	24,900		34,600	32,900			34,500			
30	30,200	26,200	22,900	20,200	34,600	30,300	25,100		34,500	33,500		
35	27,200	24,000	20,700	19,000	34,500	28,100	23,600	20,300	34,500	31,400	25,200	
40	24,800	21,400	19,400	18,000	31,600	26,200	21,700	19,500	34,500	29,500	24,000	20,400
45	21,900	19,900	18,200	17,200	29,100	24,600	20,700	18,700	34,500	27,800	23,000	19,700
50	20,200	18,600	17,300	16,400	27,000	23,100	19,700	18,000	32,500	26,300	21,500	19,100
55	18,800	17,500	16,400	15,800	25,100	21,200	18,900	17,400	30,400	25,000	20,700	18,500
60	17,500	16,500	15,700	15,300	23,500	20,100	18,100	16,900	28,600	23,800	20,000	18,000
65	16,400	15,600	15,000	14,900	21,400	19,200	17,400	16,400	26,700	22,700	19,300	17,500
70	15,400	14,900	14,600		20,200	18,300	16,800	15,900	24,800	21,200	18,600	17,100
75	14,500	14,300			19,200	17,500	16,200	15,600	23,200	20,400	18,000	16,700
80					18,200	16,800	15,700	15,300	22,000	19,600	17,500	16,400
85					17,300	16,100	15,300	15,000	20,200	18,800	17,000	16,000
90					16,500	15,500	14,900		18,200	18,200	16,600	15,700
95					15,700	15,000	14,600		16,600	17,200	16,200	15,500
100					15,100	14,600			15,100	15,600	15,800	15,300
105					9,500				13,700	14,200	14,600	14,800
110									12,500	12,900	13,200	13,300
115									11,300	11,700	12,000	
120									10,300	10,600	10,800	
125									9,400	9,700	9,800	
130									8,600	8,800		
135									7,900			
Min Angle	0.0	0.0	0.0	0.0	0.0	0.0	0.0	0.0	0.0	0.0	0.0	0.0
Max Rad.	75.9	75.8	74.5	71.9	105.1	104.9	103.2	100.0	135.3	135.1	133.1	129.6
Capacity	11,200	11,400	12,100	13,600	3,700	3,700	3,900	4,200	2,600	2,600	2,700	2,900

1031060



PORTLAND OFFICE: 503.283.3111
 SEATTLE OFFICE: 206.784.1054
WWW.NESSCAMPBELL.COM

Rated Lifting Capacities in Pounds

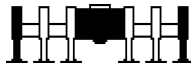

Full

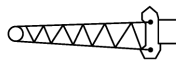

40ft Offset Fly



36,000 lbs



Radius (ft)	Boom Length (ft)											
	Fly Offset											
	119.4				135.4				152.0			
	2°	15°	30°	45°	2°	15°	30°	45°	2°	15°	30°	45°
25	33,900				34,400							
30	33,900				34,400				33,800			
35	33,900	32,700			34,400	33,900			33,800			
40	33,900	30,900	24,700		34,400	32,100			33,800	33,300		
45	33,900	29,200	23,700	20,100	34,400	30,500	24,300		33,800	31,700	24,900	
50	33,900	27,700	22,800	19,500	34,400	29,000	23,400	19,900	33,800	30,200	24,000	20,200
55	33,000	26,400	21,500	19,000	34,400	27,700	22,100	19,400	33,800	28,900	23,200	19,700
60	31,000	25,200	20,700	18,500	33,400	26,500	21,400	18,900	33,400	27,700	22,000	19,200
65	28,900	24,100	20,000	18,000	30,500	25,400	20,700	18,400	28,900	26,600	21,400	18,800
70	27,000	23,100	19,400	17,600	26,700	24,300	20,100	18,000	25,200	25,500	20,800	18,400
75	24,600	21,600	18,800	17,200	23,600	23,400	19,600	17,600	22,100	23,400	20,200	18,000
80	22,000	20,800	18,300	16,900	20,900	22,000	19,000	17,300	19,500	20,600	19,700	17,700
85	19,700	20,100	17,800	16,500	18,700	19,600	18,500	17,000	17,200	18,300	19,200	17,400
90	17,700	18,400	17,300	16,200	16,900	17,500	18,100	16,700	15,500	16,500	17,200	17,100
95	16,100	16,800	16,900	15,900	15,200	15,900	16,700	16,400	13,800	14,700	15,500	16,200
100	14,600	15,200	15,800	15,700	13,600	14,300	15,000	15,500	12,200	13,000	13,900	14,500
105	13,200	13,700	14,200	14,600	12,200	12,900	13,500	13,900	10,900	11,600	12,400	12,900
110	11,900	12,400	12,900	13,100	11,000	11,600	12,200	12,500	9,600	10,300	11,000	11,500
115	10,800	11,300	11,700	11,900	9,900	10,400	10,900	11,200	8,500	9,200	9,800	10,200
120	9,800	10,200	10,500	10,700	8,900	9,400	9,800	10,100	7,500	8,100	8,700	9,000
125	8,900	9,200	9,500		8,000	8,400	8,800	9,000	6,600	7,200	7,700	8,000
130	8,100	8,300	8,600		7,100	7,500	7,900	8,000	5,800	6,300	6,700	7,000
135	7,300	7,500	7,700		6,400	6,700	7,000	7,100	5,000	5,500	5,900	6,100
140	6,600	6,800	6,900		5,700	6,000	6,200		4,300	4,700	5,100	5,300
145	6,000	6,100			5,000	5,300	5,500		3,700	4,100	4,400	4,500
150					4,400	4,600	4,800		3,100	3,400	3,700	
155					3,900	4,100			2,500	2,800	3,100	
160					3,400	3,500				2,300	2,500	
Min Angle	10.0	11.0	0.0	0.0	12.0	13.5	21.5	5.0	32.0	31.5	32.0	32.0
Max Rad.	150.0	150.0	148.6	144.9	165.0	165.0	160.0	158.9	160.0	163.0	164.2	163.6
Capacity	0	0	2,000	2,200	0	0	0	0	0	0	0	0

1031060



PORTLAND OFFICE: 503.283.3111
 SEATTLE OFFICE: 206.784.1054
WWW.NESSCAMPBELL.COM

Rated Lifting Capacities in Pounds

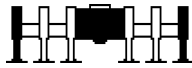

Full

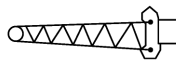

40ft Offset Fly



36,000 lbs



Radius (ft)	Boom Length (ft)			
	Fly Offset			
	168.5			
	2°	15°	30°	45°
35	29,200			
40	29,200			
45	29,200	29,000		
50	29,200	29,000		
55	29,200	29,000	23,800	
60	29,200	28,800	23,100	19,600
65	27,600	27,700	22,000	19,200
70	23,900	25,400	21,400	18,800
75	20,800	22,200	20,800	18,400
80	18,200	19,500	20,300	18,100
85	16,300	17,100	18,300	17,700
90	14,300	15,400	16,500	17,000
95	12,600	13,600	14,600	15,300
100	11,100	12,000	12,900	13,600
105	9,700	10,500	11,400	12,000
110	8,500	9,300	10,000	10,600
115	7,400	8,100	8,800	9,300
120	6,400	7,100	7,700	8,200
125	5,500	6,100	6,700	7,100
130	4,600	5,200	5,800	6,100
135	3,900	4,400	4,900	5,300
140	3,200	3,700	4,200	4,400
145	2,600	3,000	3,400	3,700
150		2,400	2,800	2,900
155			2,100	2,300
Min Angle	44.0	44.5	45.0	44.5
Max Rad.	150.0	153.3	155.8	157.5
Capacity	0	0	0	0

1031060



PORTLAND OFFICE: 503.283.3111
 SEATTLE OFFICE: 206.784.1054
WWW.NESSCAMPBELL.COM

Rated Lifting Capacities in Pounds

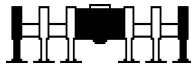

Full

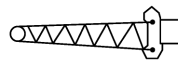

40ft Hydraulic Offset Fly



36,000 lbs



Radius (ft)	Boom Length (ft)											
	Fly Offset											
	44.3			73.5			103.8			134.9		
	2°-15°	15°-30°	30°-45°	2°-15°	15°-30°	30°-45°	2°-15°	15°-30°	30°-45°	2°-15°	15°-30°	30°-45°
10	34,700											
12	34,700	34,700		34,600								
15	34,700	34,700		34,600								
20	32,000	27,100	27,100	34,600	34,600		34,500					
25	28,800	24,900	24,900	32,900	32,900		34,500	34,500		29,700		
30	26,200	22,900	20,200	30,300	25,100	25,100	33,500	33,500		29,700		
35	24,000	20,700	19,000	28,100	23,600	20,300	31,400	25,200	25,200	29,500	29,500	
40	21,400	19,400	18,000	26,200	21,700	19,500	29,500	24,000	20,400	29,500	25,300	25,300
45	19,900	18,200	17,200	24,600	20,700	18,700	27,800	23,000	19,700	29,500	24,300	20,400
50	18,600	17,300	16,400	23,100	19,700	18,000	26,300	21,500	19,100	29,000	23,400	19,900
55	17,500	16,400	15,800	21,200	18,900	17,400	25,000	20,700	18,500	27,700	22,100	19,300
60	16,500	15,700	15,300	20,100	18,100	16,900	23,800	20,000	18,000	26,400	21,400	18,900
65	15,600	15,000	14,900	19,200	17,400	16,400	22,700	19,300	17,500	25,300	20,700	18,400
70	14,900	14,600	14,600	18,300	16,800	15,900	21,200	18,600	17,100	24,300	20,100	18,000
75	14,300	14,300		17,500	16,200	15,600	20,400	18,000	16,700	23,400	19,600	17,600
80				16,800	15,700	15,300	19,600	17,500	16,400	21,500	19,000	17,300
85				16,100	15,300	15,000	18,800	17,000	16,000	19,200	18,500	17,000
90				15,500	14,900	14,900	18,200	16,600	15,700	17,200	18,000	16,600
95				15,000	14,600	14,600	16,600	16,200	15,500	15,700	16,400	16,400
100				14,600	14,500		15,100	15,600	15,300	14,100	14,800	15,500
105				9,500			13,700	14,200	14,600	12,700	13,400	14,000
110							12,500	12,900	13,200	11,500	12,100	12,600
115							11,300	11,700	12,000	10,400	10,900	11,400
120							10,300	10,600	10,800	9,400	9,800	10,300
125							9,400	9,700	9,600	8,500	8,900	9,300
130							8,600	8,800		7,600	8,000	8,300
135							7,900			6,800	7,200	7,500
140										6,100	6,400	6,700
145										5,500	5,800	5,900
150										4,900	5,100	5,200
155										4,300	4,500	4,500
160										3,800		
Min Angle	0.0	0.0	0.0	0.0	0.0	0.0	0.0	0.0	0.0	11.5	21.5	4.5
Max Rad.	75.9	75.8	74.5	105.1	104.9	103.2	135.3	135.1	133.1	165.0	160.0	158.4
Capacity	11,200	11,400	12,100	3,700	3,700	3,900	2,600	2,600	2,700	0	0	0

1032040



PORTLAND OFFICE: 503.283.3111
 SEATTLE OFFICE: 206.784.1054
WWW.NESSCAMPBELL.COM

Rated Lifting Capacities in Pounds

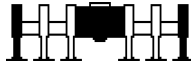

Full

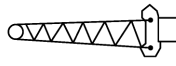

40ft Hydraulic Offset Fly



36,000 lbs



Radius (ft)	Boom Length (ft)								
	Fly Offset								
	167.1			183.6			200.1		
	2°-15°	15°-30°	30°-45°	2°-15°	15°-30°	30°-45°	2°-15°	15°-30°	30°-45°
30	19,800								
35	19,800			18,600					
40	19,700	19,700		18,400	18,400		16,100		
45	19,700	19,500	19,500	18,400	18,400		16,000	16,000	
50	19,700	19,500	19,500	18,400	18,400		16,000	16,000	
55	19,700	19,500	19,200	18,400	18,300	18,300	16,000	15,800	15,800
60	19,700	19,500	19,200	18,400	18,300	18,000	16,000	15,800	15,600
65	19,700	19,500	19,100	18,400	18,300	18,000	16,000	15,800	15,600
70	19,700	19,500	18,700	18,400	18,300	18,000	16,000	15,800	15,600
75	19,700	19,500	18,400	18,400	18,300	18,000	16,000	15,800	15,600
80	19,700	19,500	18,000	18,400	18,300	18,000	16,000	15,800	15,600
85	17,500	18,600	17,700	16,700	17,500	18,000	15,700	15,800	15,600
90	15,900	16,800	17,400	14,700	15,800	16,900	13,700	14,900	15,600
95	14,100	15,000	15,900	13,000	14,000	15,000	12,000	13,100	14,200
100	12,600	13,400	14,200	11,500	12,400	13,300	10,500	11,500	12,500
105	11,200	12,000	12,700	10,100	10,900	11,800	9,100	10,100	11,000
110	10,000	10,700	11,400	8,900	9,700	10,500	7,900	8,800	9,600
115	8,900	9,500	10,200	7,800	8,500	9,200	6,800	7,600	8,400
120	7,900	8,500	9,100	6,800	7,500	8,100	5,800	6,600	7,300
125	7,000	7,500	8,100	5,900	6,500	7,100	4,900	5,600	6,300
130	6,100	6,600	7,100	5,000	5,600	6,200	4,100	4,800	5,400
135	5,400	5,800	6,300	4,300	4,800	5,400	3,300	4,000	4,600
140	4,600	5,100	5,500	3,600	4,100	4,600	2,600	3,200	3,800
145	4,000	4,400	4,800	2,900	3,400	3,900		2,600	3,100
150	3,400	3,800	4,100	2,300	2,800	3,200			2,400
155	2,800	3,200	3,500		2,200	2,600			
160	2,300	2,600	2,900						
165		2,100	2,400						
Min Angle	38.0	38.5	38.5	48.0	48.0	48.5	54.5	55.0	55.0
Max Rad.	163.0	166.3	168.3	153.0	157.0	160.0	145.0	149.3	153.3
Capacity	0	0	0	0	0	0	0	0	0

1032040



PORTLAND OFFICE: 503.283.3111
 SEATTLE OFFICE: 206.784.1054
WWW.NESSCAMPBELL.COM

Rated Lifting Capacities in Pounds

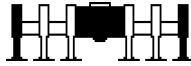

Full

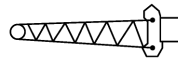

40ft Hydraulic Offset Fly



36,000 lbs



Radius (ft)	Boom Length (ft)											
	Fly Offset											
	44.3			58.9			89.1			120.3		
	2°-15°	15°-30°	30°-45°	2°-15°	15°-30°	30°-45°	2°-15°	15°-30°	30°-45°	2°-15°	15°-30°	30°-45°
10	34,700			34,700								
12	34,700	34,700		34,700								
15	34,700	34,700		34,700	34,700		34,600					
20	32,000	27,100	27,100	34,200	34,200		34,600	34,600				
25	28,800	24,900	24,900	31,100	25,900	25,900	34,600	34,600		34,500		
30	26,200	22,900	20,200	28,400	24,100	20,800	32,100	25,900	25,900	34,500	34,500	
35	24,000	20,700	19,000	26,200	21,900	19,800	29,900	24,500	20,800	32,800	25,800	25,800
40	21,400	19,400	18,000	24,300	20,700	18,800	28,000	23,300	20,000	30,900	24,700	24,700
45	19,900	18,200	17,200	22,000	19,600	18,000	26,300	21,700	19,300	29,300	23,700	20,100
50	18,600	17,300	16,400	20,600	18,600	17,300	24,900	20,700	18,600	27,800	22,800	19,500
55	17,500	16,400	15,800	19,500	17,800	16,700	23,600	19,900	18,000	26,500	21,500	19,000
60	16,500	15,700	15,300	18,400	17,000	16,100	21,800	19,100	17,500	25,300	20,800	18,500
65	15,600	15,000	14,900	17,500	16,300	15,700	20,800	18,400	17,000	24,200	20,100	18,000
70	14,900	14,600	14,600	16,700	15,700	15,300	19,900	17,800	16,600	23,200	19,500	17,600
75	14,300	14,300		15,900	15,200	15,000	19,000	17,200	16,200	21,700	18,900	17,200
80				15,300	14,800	14,800	18,300	16,700	15,800	20,900	18,300	16,900
85				14,700	14,500	14,500	17,600	16,200	15,500	18,800	17,900	16,500
90				14,300			16,900	15,800	15,300	17,000	17,400	16,200
95							16,300	15,400	15,100	15,300	16,000	16,000
100							14,700	15,100	14,900	13,700	14,400	15,000
105							13,300	13,700	14,000	12,400	13,000	13,500
110							12,100	12,400	12,500	11,100	11,700	12,200
115							11,000	11,200		10,000	10,500	10,900
120							10,100			9,000	9,400	9,800
125										8,100	8,500	8,800
130										7,300	7,600	7,800
135										6,500	6,800	6,900
140										5,800	6,000	6,000
145										5,200	5,300	
150										4,600	4,700	
Min Angle	0.0	0.0	0.0	0.0	0.0	0.0	0.0	0.0	0.0	0.0	0.0	0.0
Max Rad.	75.9	75.8	74.5	90.5	90.4	88.8	120.7	120.5	118.6	151.9	151.6	149.6
Capacity	11,200	11,400	12,100	6,600	6,700	7,000	4,900	5,000	5,200	3,200	3,200	3,400

1032050



PORTLAND OFFICE: 503.283.3111
 SEATTLE OFFICE: 206.784.1054
WWW.NESSCAMPBELL.COM

Rated Lifting Capacities in Pounds

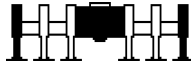

Full

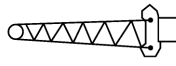

40ft Hydraulic Offset Fly



36,000 lbs



Radius (ft)	Boom Length (ft)								
	Fly Offset								
	152.4			169.0			185.5		
	2°-15°	15°-30°	30°-45°	2°-15°	15°-30°	30°-45°	2°-15°	15°-30°	30°-45°
30	31,300								
35	31,000	31,000							
40	31,000	31,000		29,200			20,200		
45	31,000	24,900	24,900	29,000	29,000		20,100	20,100	
50	30,300	24,000	20,200	29,000	24,500	24,500	20,100	20,100	
55	28,900	23,200	19,700	29,000	23,800	23,800	20,100	19,800	19,800
60	27,700	22,000	19,300	28,800	23,100	19,600	20,100	19,800	19,800
65	26,600	21,400	18,800	27,500	22,000	19,200	20,100	19,800	19,500
70	25,100	20,800	18,400	23,800	21,400	18,800	20,100	19,800	19,100
75	22,000	20,200	18,100	20,800	20,800	18,400	19,700	19,800	18,700
80	19,400	19,700	17,700	18,200	19,400	18,100	17,100	18,500	18,400
85	17,100	18,200	17,400	16,200	17,100	17,800	15,200	16,400	17,400
90	15,400	16,400	17,100	14,200	15,300	16,400	13,200	14,400	15,600
95	13,700	14,600	15,500	12,500	13,500	14,500	11,500	12,600	13,700
100	12,200	13,000	13,800	11,000	11,900	12,800	10,000	11,000	12,000
105	10,800	11,600	12,300	9,600	10,500	11,300	8,600	9,600	10,500
110	9,600	10,300	10,900	8,400	9,200	10,000	7,400	8,300	9,200
115	8,500	9,100	9,700	7,300	8,100	8,800	6,300	7,200	8,000
120	7,500	8,100	8,600	6,300	7,000	7,700	5,400	6,100	6,900
125	6,500	7,100	7,600	5,400	6,100	6,700	4,500	5,200	5,900
130	5,700	6,200	6,700	4,600	5,200	5,700	3,600	4,300	4,900
135	5,000	5,400	5,800	3,800	4,400	4,900	2,900	3,500	4,100
140	4,300	4,700	5,000	3,100	3,600	4,100	2,200	2,800	3,300
145	3,600	4,000	4,300	2,500	3,000	3,400		2,100	2,600
150	3,000	3,400	3,600		2,300	2,700			
155	2,500	2,800	3,000			2,100			
160		2,200	2,400						
Min Angle	33.0	33.0	33.0	45.0	45.0	45.0	52.5	52.5	53.0
Max Rad. Capacity	159.2	162.0	163.3	149.2	152.5	155.8	141.4	145.8	149.3
	0	0	0	0	0	0	0	0	0

1032050



PORTLAND OFFICE: 503.283.3111
 SEATTLE OFFICE: 206.784.1054
WWW.NESSCAMPBELL.COM

Rated Lifting Capacities in Pounds

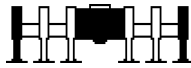

Full

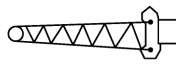

40ft Hydraulic Offset Fly



36,000 lbs



Boom Length (ft)												
Fly Offset												
Radius (ft)	44.3			73.5			103.8			119.4		
	2°-15°	15°-30°	30°-45°	2°-15°	15°-30°	30°-45°	2°-15°	15°-30°	30°-45°	2°-15°	15°-30°	30°-45°
10	34,700											
12	34,700	34,700		34,600								
15	34,700	34,700		34,600								
20	32,000	27,100	27,100	34,600	34,600		34,500					
25	28,800	24,900	24,900	32,900	32,900		34,500	34,500		33,900		
30	26,200	22,900	20,200	30,300	25,100	25,100	33,500	33,500		33,600	33,600	
35	24,000	20,700	19,000	28,100	23,600	20,300	31,400	25,200	25,200	32,700	25,800	25,800
40	21,400	19,400	18,000	26,200	21,700	19,500	29,500	24,000	20,400	30,900	24,700	20,700
45	19,900	18,200	17,200	24,600	20,700	18,700	27,800	23,000	19,700	29,200	23,700	20,100
50	18,600	17,300	16,400	23,100	19,700	18,000	26,300	21,500	19,100	27,700	22,800	19,500
55	17,500	16,400	15,800	21,200	18,900	17,400	25,000	20,700	18,500	26,400	21,500	19,000
60	16,500	15,700	15,300	20,100	18,100	16,900	23,800	20,000	18,000	25,200	20,700	18,500
65	15,600	15,000	14,900	19,200	17,400	16,400	22,700	19,300	17,500	24,100	20,000	18,000
70	14,900	14,600	14,600	18,300	16,800	15,900	21,200	18,600	17,100	23,100	19,400	17,600
75	14,300	14,300		17,500	16,200	15,600	20,400	18,000	16,700	21,600	18,800	17,200
80				16,800	15,700	15,300	19,600	17,500	16,400	20,800	18,300	16,900
85				16,100	15,300	15,000	18,800	17,000	16,000	19,700	17,800	16,500
90				15,500	14,900	14,900	18,200	16,600	15,700	17,700	17,300	16,200
95				15,000	14,600	14,600	16,600	16,200	15,500	16,100	16,800	15,900
100				14,600	14,500		15,100	15,600	15,300	14,600	15,200	15,700
105				9,500			13,700	14,200	14,600	13,200	13,700	14,200
110							12,500	12,900	13,200	11,900	12,400	12,900
115							11,300	11,700	12,000	10,800	11,300	11,700
120							10,300	10,600	10,800	9,800	10,200	10,500
125							9,400	9,700	9,600	8,900	9,200	9,500
130							8,600	8,800		8,100	8,300	8,600
135							7,900			7,300	7,500	7,700
140										6,600	6,800	6,800
145										6,000	6,100	
Min Angle	0.0	0.0	0.0	0.0	0.0	0.0	0.0	0.0	0.0	10.0	11.0	0.0
Max Rad.	75.9	75.8	74.5	105.1	104.9	103.2	135.3	135.1	133.1	150.0	150.0	148.6
Capacity	11,200	11,400	12,100	3,700	3,700	3,900	2,600	2,600	2,700	0	0	2,000

1032060



PORTLAND OFFICE: 503.283.3111
 SEATTLE OFFICE: 206.784.1054
WWW.NESSCAMPBELL.COM

Rated Lifting Capacities in Pounds

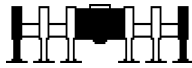

Full

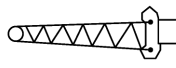

40ft Hydraulic Offset Fly



36,000 lbs



Radius (ft)	Boom Length (ft)								
	Fly Offset								
	135.4			152.0			168.5		
	2°-15°	15°-30°	30°-45°	2°-15°	15°-30°	30°-45°	2°-15°	15°-30°	30°-45°
25	34,400								
30	34,400			33,800					
35	33,900	33,900		33,500	33,500		29,200		
40	32,100	25,300	25,300	33,300	33,300		28,900	28,900	
45	30,500	24,300	20,400	31,700	24,900	24,900	28,900	28,900	
50	29,000	23,400	19,900	30,200	24,000	20,200	28,900	24,500	24,500
55	27,700	22,100	19,400	28,900	23,200	19,700	28,900	23,800	20,000
60	26,500	21,400	18,900	27,700	22,000	19,200	28,800	23,100	19,600
65	25,400	20,700	18,400	26,600	21,400	18,800	27,600	22,000	19,200
70	24,300	20,100	18,000	25,200	20,800	18,400	23,900	21,400	18,800
75	23,400	19,600	17,600	22,100	20,200	18,000	20,800	20,800	18,400
80	20,900	19,000	17,300	19,500	19,700	17,700	18,200	19,500	18,100
85	18,700	18,500	17,000	17,200	18,300	17,400	16,300	17,100	17,700
90	16,900	17,500	16,700	15,500	16,500	17,100	14,300	15,400	16,500
95	15,200	15,900	16,400	13,800	14,700	15,500	12,600	13,600	14,600
100	13,600	14,300	15,000	12,200	13,000	13,900	11,100	12,000	12,900
105	12,200	12,900	13,500	10,900	11,600	12,400	9,700	10,500	11,400
110	11,000	11,600	12,200	9,600	10,300	11,000	8,500	9,300	10,000
115	9,900	10,400	10,900	8,500	9,200	9,800	7,400	8,100	8,800
120	8,900	9,400	9,800	7,500	8,100	8,700	6,400	7,100	7,700
125	8,000	8,400	8,800	6,600	7,200	7,700	5,500	6,100	6,700
130	7,100	7,500	7,900	5,800	6,300	6,700	4,600	5,200	5,800
135	6,400	6,700	7,000	5,000	5,500	5,900	3,900	4,400	4,900
140	5,700	6,000	6,200	4,300	4,700	5,100	3,200	3,700	4,200
145	5,000	5,300	5,500	3,700	4,100	4,400	2,600	3,000	3,400
150	4,400	4,600	4,700	3,100	3,400	3,700		2,400	2,800
155	3,900	4,100		2,500	2,800	3,100			2,100
160	3,400				2,300	2,500			
Min Angle	12.0	21.5	5.0	32.0	31.5	32.0	44.0	44.5	45.0
Max Rad. Capacity	165.0	160.0	158.9	160.0	163.0	163.6	150.0	153.3	155.8
Capacity	0	0	0	0	0	0	0	0	0

1032060



PORTLAND OFFICE: 503.283.3111
 SEATTLE OFFICE: 206.784.1054
WWW.NESSCAMPBELL.COM

Rated Lifting Capacities in Pounds

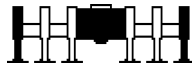

Full

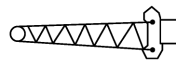

67ft Offset Fly



36,000 lbs



Radius (ft)	Boom Length (ft)											
	Fly Offset											
	44.3				73.5				103.8			
	2°	15°	30°	45°	2°	15°	30°	45°	2°	15°	30°	45°
15	30,000											
20	27,800				27,500							
25	24,600	19,800			27,500				18,200			
30	21,100	18,100			21,400				18,200			
35	19,100	16,600			21,400	18,500			18,200			
40	17,400	15,400	13,700		21,100	17,300			18,200	18,100		
45	16,000	14,300	12,800		19,500	16,200	13,700		18,200	17,700		
50	14,800	13,300	12,100		18,100	15,300	13,100		18,200	16,800		
55	13,800	12,500	11,400	10,600	16,900	14,400	12,400		18,200	15,900	13,200	
60	12,800	11,700	10,800	10,100	15,800	13,600	11,900	10,700	18,200	15,200	12,700	
65	12,000	11,100	10,300	9,700	14,900	12,900	11,400	10,300	17,500	14,500	12,200	10,800
70	11,200	10,500	9,800	9,300	14,000	12,300	10,900	10,000	16,600	13,800	11,800	10,500
75	10,600	9,900	9,300	8,900	13,200	11,700	10,500	9,700	15,700	13,200	11,400	10,200
80	10,000	9,400	8,900	8,600	12,500	11,200	10,100	9,400	14,900	12,700	11,000	9,900
85	9,400	9,000	8,600	8,400	11,900	10,700	9,800	9,100	14,200	12,200	10,600	9,700
90	8,900	8,600	8,300	8,200	11,300	10,300	9,400	8,900	13,500	11,700	10,300	9,400
95	8,500	8,200	8,000		10,800	9,900	9,100	8,700	12,900	11,300	10,000	9,200
100	8,100	7,900			10,300	9,500	8,900	8,500	12,400	10,900	9,700	9,000
105					9,800	9,100	8,600	8,300	11,800	10,500	9,500	8,900
110					9,400	8,800	8,400	8,200	11,400	10,200	9,200	8,700
115					9,000	8,500	8,200	8,200	10,900	9,800	9,000	8,500
120					8,700	8,300	8,000		10,500	9,500	8,800	8,400
125					8,300	8,100	8,000		10,100	9,300	8,600	8,300
130									9,500	9,000	8,400	8,200
135									8,700	8,800	8,300	8,200
140									8,000	8,400	8,200	8,200
145									7,400	7,700	8,000	
150									6,700	7,000	7,200	
155									6,200	6,400		
Min Angle	0.0	0.0	0.0	0.0	14.0	18.5	0.0	0.0	14.0	17.5	26.0	11.5
Max Rad.	102.9	102.7	100.7	96.8	130.0	130.0	128.9	123.9	160.0	160.0	155.0	146.4
Capacity	6,200	6,400	7,000	8,200	0	0	2,000	2,300	0	0	0	0

1031070



PORTLAND OFFICE: 503.283.3111
 SEATTLE OFFICE: 206.784.1054
WWW.NESSCAMPBELL.COM

Rated Lifting Capacities in Pounds

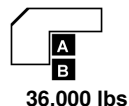
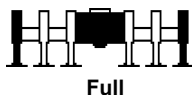

Radius (ft)	Boom Length (ft)											
	Fly Offset											
	134.9				167.1				183.6			
	2°	15°	30°	45°	2°	15°	30°	45°	2°	15°	30°	45°
30	15,900											
35	15,900				13,300							
40	15,900				13,300				12,400			
45	15,900	15,800			13,300				12,400			
50	15,900	15,800			13,300				12,400			
55	15,900	15,800			13,300	13,300			12,400			
60	15,900	15,800	13,300		13,300	13,300			12,400	12,300		
65	15,900	15,800	12,900		13,300	13,300			12,400	12,300		
70	15,900	15,100	12,400		13,300	13,300	13,000		12,400	12,300		
75	15,900	14,500	12,100	10,500	13,300	13,300	12,600		12,400	12,300	12,300	
80	15,900	14,000	11,700	10,300	13,300	13,300	12,300	10,600	12,400	12,300	12,300	
85	15,900	13,500	11,400	10,100	13,300	13,300	12,000	10,400	12,400	12,300	12,200	
90	15,700	13,000	11,100	9,800	13,300	13,300	11,600	10,200	12,400	12,300	11,900	10,300
95	15,000	12,600	10,800	9,600	13,300	13,300	11,400	10,000	12,400	12,300	11,600	10,100
100	14,400	12,100	10,500	9,500	13,300	13,300	11,100	9,800	12,300	12,300	11,400	10,000
105	13,600	11,700	10,200	9,300	12,000	12,900	10,800	9,600	10,900	12,300	11,100	9,800
110	12,400	11,400	10,000	9,100	10,800	12,000	10,600	9,500	9,700	11,100	10,900	9,600
115	11,200	11,000	9,700	9,000	9,600	10,800	10,400	9,300	8,600	9,900	10,600	9,500
120	10,200	10,700	9,500	8,800	8,600	9,700	10,100	9,200	7,500	8,800	10,000	9,300
125	9,300	10,100	9,300	8,700	7,700	8,700	9,800	9,000	6,600	7,800	9,000	9,200
130	8,400	9,200	9,100	8,600	6,800	7,800	8,800	8,900	5,800	6,900	8,000	8,800
135	7,600	8,300	8,900	8,500	6,100	7,000	7,900	8,600	5,000	6,000	7,000	7,800
140	6,900	7,500	8,200	8,400	5,300	6,200	7,000	7,700	4,300	5,200	6,200	6,900
145	6,200	6,800	7,400	7,700	4,700	5,500	6,300	6,800	3,600	4,500	5,400	6,100
150	5,600	6,200	6,700	7,000	4,100	4,800	5,500	6,000	3,000	3,900	4,700	5,300
155	5,000	5,500	6,000	6,200	3,500	4,200	4,900	5,300	2,400	3,200	4,000	4,600
160	4,500	5,000	5,300	5,500	3,000	3,600	4,200	4,600		2,700	3,400	3,900
165	4,000	4,400	4,700		2,500	3,100	3,600	4,000		2,100	2,800	3,300
170	3,600	3,900	4,200			2,600	3,100	3,400			2,300	2,700
175	3,100	3,400	3,600			2,100	2,600	2,800				2,100
180	2,700	3,000	3,100				2,100	2,300				
185	2,400	2,500										
Min Angle	15.5	18.0	24.5	17.0	45.0	45.5	46.0	46.5	53.0	53.5	54.0	54.0
Max Rad.	190.0	190.0	185.0	177.6	170.0	176.3	181.0	182.5	159.0	166.0	172.5	175.8
Capacity	0	0	0	0	0	0	0	0	0	0	0	0

1031070



PORTLAND OFFICE: 503.283.3111
 SEATTLE OFFICE: 206.784.1054
WWW.NESSCAMPBELL.COM

Rated Lifting Capacities in Pounds

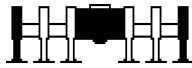

Full

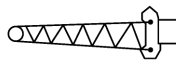

67ft Offset Fly



36,000 lbs



Radius (ft)	Boom Length (ft)			
	Fly Offset			
	200.1			
	2°	15°	30°	45°
45	10,800			
50	10,800			
55	10,800			
60	10,800			
65	10,800	10,800		
70	10,800	10,800		
75	10,800	10,800		
80	10,800	10,800	10,700	
85	10,800	10,800	10,700	
90	10,800	10,800	10,700	
95	10,800	10,800	10,700	10,300
100	10,800	10,800	10,700	10,100
105	9,900	10,800	10,700	9,900
110	8,700	10,200	10,700	9,800
115	7,600	9,000	10,500	9,600
120	6,600	7,900	9,300	9,500
125	5,700	6,900	8,200	9,300
130	4,800	6,000	7,200	8,200
135	4,000	5,200	6,300	7,200
140	3,300	4,400	5,500	6,300
145	2,700	3,700	4,700	5,500
150	2,100	3,000	4,000	4,700
155		2,400	3,300	3,900
160			2,700	3,300
165			2,100	2,600
Min Angle	58.5	59.0	59.5	60.0
Max Rad.	150.8	158.3	165.8	170.0
Capacity	0	0	0	0

1031070



PORTLAND OFFICE: 503.283.3111
 SEATTLE OFFICE: 206.784.1054
WWW.NESSCAMPBELL.COM

Rated Lifting Capacities in Pounds

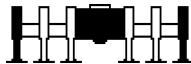

Full

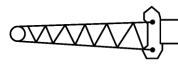

67ft Offset Fly



36,000 lbs



Radius (ft)	Boom Length (ft)											
	Fly Offset											
	44.3				58.9				89.1			
	2°	15°	30°	45°	2°	15°	30°	45°	2°	15°	30°	45°
15	30,000											
20	27,800				30,000				28,400			
25	24,600	19,800			26,900				28,400			
30	21,100	18,100			24,100	19,100			28,100			
35	19,100	16,600			21,100	17,700			25,600	19,300		
40	17,400	15,400	13,700		19,300	16,400			23,500	18,100		
45	16,000	14,300	12,800		17,800	15,300	13,300		21,100	17,000		
50	14,800	13,300	12,100		16,500	14,400	12,600		19,700	16,100	13,400	
55	13,800	12,500	11,400	10,600	15,400	13,500	12,000	10,900	18,400	15,200	12,900	
60	12,800	11,700	10,800	10,100	14,400	12,700	11,400	10,400	17,300	14,500	12,300	10,900
65	12,000	11,100	10,300	9,700	13,500	12,100	10,900	10,000	16,300	13,800	11,800	10,600
70	11,200	10,500	9,800	9,300	12,700	11,400	10,400	9,700	15,300	13,100	11,400	10,300
75	10,600	9,900	9,300	8,900	11,900	10,900	10,000	9,300	14,500	12,500	11,000	10,000
80	10,000	9,400	8,900	8,600	11,300	10,400	9,600	9,000	13,800	12,000	10,600	9,700
85	9,400	9,000	8,600	8,400	10,700	9,900	9,200	8,800	13,100	11,500	10,200	9,400
90	8,900	8,600	8,300	8,200	10,200	9,500	8,900	8,600	12,500	11,100	9,900	9,200
95	8,500	8,200	8,000		9,700	9,100	8,600	8,400	11,900	10,600	9,600	9,000
100	8,100	7,900			9,200	8,700	8,300	8,200	11,400	10,200	9,300	8,800
105					8,800	8,400	8,100		10,900	9,900	9,100	8,600
110					8,400	8,100	8,000		10,400	9,500	8,800	8,500
115					8,100	7,900			10,000	9,200	8,600	8,300
120									9,600	8,900	8,400	8,200
125									9,300	8,700	8,300	8,200
130									8,900	8,400	8,100	
135									8,600	8,200	8,000	
140									8,000	8,000	8,000	
145									7,300	7,500		
Min Angle	0.0	0.0	0.0	0.0	0.0	0.0	0.0	0.0	0.0	0.0	0.0	0.0
Max Rad.	102.9	102.7	100.7	96.8	117.5	117.1	114.7	110.2	147.7	147.1	144.1	138.7
Capacity	6,200	6,400	7,000	8,200	3,600	3,700	4,100	4,700	2,600	2,600	2,900	3,400

1031080



PORTLAND OFFICE: 503.283.3111
 SEATTLE OFFICE: 206.784.1054
WWW.NESSCAMPBELL.COM

Rated Lifting Capacities in Pounds

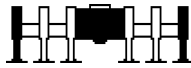

Full

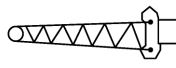

67ft Offset Fly



36,000 lbs



Radius (ft)	Boom Length (ft)											
	Fly Offset											
	120.3				152.4				169.0			
	2°	15°	30°	45°	2°	15°	30°	45°	2°	15°	30°	45°
25	19,500											
30	19,500											
35	19,500				16,600				15,500			
40	19,500				16,600				15,500			
45	19,500	18,400			16,600				15,500			
50	19,500	17,500			16,600	16,500			15,500			
55	19,500	16,600	13,500		16,600	16,500			15,500	15,500		
60	19,500	15,900	13,000		16,600	16,500			15,500	15,500		
65	18,900	15,200	12,600		16,600	16,400	13,100		15,500	15,500		
70	17,900	14,500	12,200	10,700	16,600	15,800	12,700		15,500	15,500	13,000	
75	17,000	14,000	11,800	10,400	16,600	15,200	12,400	10,700	15,500	15,500	12,600	
80	16,100	13,400	11,400	10,100	16,600	14,600	12,000	10,500	15,500	15,200	12,300	
85	15,400	12,900	11,100	9,900	16,600	14,100	11,700	10,200	15,500	14,700	12,000	10,400
90	14,700	12,400	10,700	9,700	16,500	13,600	11,400	10,000	15,300	14,200	11,700	10,200
95	14,000	12,000	10,400	9,500	14,700	13,200	11,100	9,800	13,600	13,700	11,400	10,000
100	13,400	11,600	10,200	9,300	13,200	12,800	10,800	9,700	12,000	13,300	11,100	9,800
105	12,900	11,200	9,900	9,100	11,800	12,400	10,600	9,500	10,600	12,100	10,900	9,700
110	12,200	10,800	9,600	8,900	10,500	11,800	10,300	9,300	9,400	10,800	10,600	9,500
115	11,100	10,500	9,400	8,800	9,400	10,600	10,100	9,200	8,300	9,600	10,400	9,300
120	10,000	10,200	9,200	8,600	8,400	9,500	9,900	9,000	7,300	8,500	9,700	9,200
125	9,100	9,900	9,000	8,500	7,500	8,500	9,500	8,900	6,300	7,500	8,700	9,100
130	8,200	9,000	8,800	8,400	6,600	7,600	8,500	8,800	5,500	6,600	7,700	8,500
135	7,500	8,100	8,600	8,300	5,800	6,700	7,600	8,200	4,700	5,700	6,700	7,500
140	6,700	7,300	7,900	8,200	5,100	5,900	6,800	7,300	4,000	5,000	5,900	6,600
145	6,100	6,600	7,100	7,300	4,400	5,200	6,000	6,500	3,300	4,200	5,100	5,700
150	5,500	5,900	6,400	6,500	3,800	4,600	5,200	5,700	2,700	3,600	4,400	5,000
155	4,900	5,300	5,700		3,300	3,900	4,600	4,900	2,200	3,000	3,700	4,200
160	4,400	4,700	5,000		2,700	3,400	3,900	4,200		2,400	3,100	3,500
165	3,900	4,200	4,400		2,200	2,800	3,300	3,600			2,500	2,900
170	3,400	3,700				2,300	2,800	3,000				2,200
175							2,200	2,400				
Min Angle	15.5	18.5	26.0	3.5	41.0	42.0	42.0	41.5	50.0	50.5	51.5	51.0
Max Rad.	175.0	175.0	170.0	163.0	167.5	173.0	177.0	178.3	156.7	163.3	169.2	172.0
Capacity	0	0	0	0	0	0	0	0	0	0	0	0

1031080



PORTLAND OFFICE: 503.283.3111
 SEATTLE OFFICE: 206.784.1054
WWW.NESSCAMPBELL.COM

Rated Lifting Capacities in Pounds

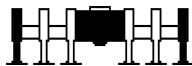

Full

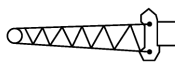

67ft Offset Fly



36,000 lbs



Radius (ft)	Boom Length (ft)			
	Fly Offset			
	185.5			
	2°	15°	30°	45°
40	13,500			
45	13,500			
50	13,500			
55	13,500			
60	13,500	13,500		
65	13,500	13,500		
70	13,500	13,500		
75	13,500	13,500	12,900	
80	13,500	13,500	12,500	
85	13,500	13,500	12,200	
90	13,500	13,500	11,900	10,300
95	12,500	13,500	11,700	10,100
100	11,000	12,800	11,400	10,000
105	9,600	11,300	11,100	9,800
110	8,400	9,900	10,900	9,600
115	7,300	8,700	10,200	9,500
120	6,300	7,600	9,000	9,400
125	5,300	6,600	7,900	8,900
130	4,500	5,700	6,900	7,900
135	3,700	4,900	6,000	6,900
140	3,000	4,100	5,200	6,000
145	2,400	3,400	4,400	5,100
150		2,700	3,600	4,300
155		2,100	3,000	3,600
160			2,300	2,900
165				2,200
Min Angle	56.5	57.0	57.5	58.0
Max Rad.	148.3	155.8	162.5	166.7
Capacity	0	0	0	0

1031080



PORTLAND OFFICE: 503.283.3111
 SEATTLE OFFICE: 206.784.1054
WWW.NESSCAMPBELL.COM

Rated Lifting Capacities in Pounds

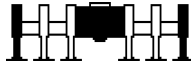

Full

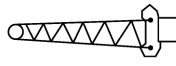

67ft Offset Fly



36,000 lbs



Radius (ft)	Boom Length (ft)											
	Fly Offset											
	44.3				73.5				103.8			
	2°	15°	30°	45°	2°	15°	30°	45°	2°	15°	30°	45°
15	30,000											
20	27,800				27,500							
25	24,600	19,800			27,500							
30	21,100	18,100			21,400				18,200			
35	19,100	16,600			21,400	18,500			18,200			
40	17,400	15,400	13,700		21,100	17,300			18,200			
45	16,000	14,300	12,800		19,500	16,200	13,700		18,200	17,700		
50	14,800	13,300	12,100		18,100	15,300	13,100		18,200	16,800		
55	13,800	12,500	11,400	10,600	16,900	14,400	12,400		18,200	15,900	13,200	
60	12,800	11,700	10,800	10,100	15,800	13,600	11,900	10,700	18,200	15,200	12,700	
65	12,000	11,100	10,300	9,700	14,900	12,900	11,400	10,300	17,500	14,500	12,200	10,800
70	11,200	10,500	9,800	9,300	14,000	12,300	10,900	10,000	16,600	13,800	11,800	10,500
75	10,600	9,900	9,300	8,900	13,200	11,700	10,500	9,700	15,700	13,200	11,400	10,200
80	10,000	9,400	8,900	8,600	12,500	11,200	10,100	9,400	14,900	12,700	11,000	9,900
85	9,400	9,000	8,600	8,400	11,900	10,700	9,800	9,100	14,200	12,200	10,600	9,700
90	8,900	8,600	8,300	8,200	11,300	10,300	9,400	8,900	13,500	11,700	10,300	9,400
95	8,500	8,200	8,000		10,800	9,900	9,100	8,700	12,900	11,300	10,000	9,200
100	8,100	7,900			10,300	9,500	8,900	8,500	12,400	10,900	9,700	9,000
105					9,800	9,100	8,600	8,300	11,800	10,500	9,500	8,900
110					9,400	8,800	8,400	8,200	11,400	10,200	9,200	8,700
115					9,000	8,500	8,200	8,200	10,900	9,800	9,000	8,500
120					8,700	8,300	8,000		10,500	9,500	8,800	8,400
125					8,300	8,100	8,000		10,100	9,300	8,600	8,300
130									9,500	9,000	8,400	8,200
135									8,700	8,800	8,300	8,200
140									8,000	8,400	8,200	8,200
145									7,400	7,700	8,000	
150									6,700	7,000	7,200	
155									6,200	6,400		
Min Angle	0.0	0.0	0.0	0.0	14.0	18.5	0.0	0.0	14.0	17.5	26.0	11.5
Max Rad.	102.9	102.7	100.7	96.8	130.0	130.0	128.9	123.9	160.0	160.0	155.0	146.4
Capacity	6,200	6,400	7,000	8,200	0	0	2,000	2,300	0	0	0	0

1031090



PORTLAND OFFICE: 503.283.3111
 SEATTLE OFFICE: 206.784.1054
WWW.NESSCAMPBELL.COM

Rated Lifting Capacities in Pounds

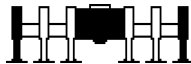

Full

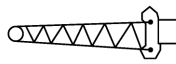

67ft Offset Fly



36,000 lbs



Radius (ft)	Boom Length (ft)											
	Fly Offset											
	119.4				135.4				152.0			
	2°	15°	30°	45°	2°	15°	30°	45°	2°	15°	30°	45°
30	17,800											
35	17,800				18,100				17,400			
40	17,800				18,100				17,400			
45	17,800				18,100	18,000			17,400			
50	17,800	17,400			18,100	18,000			17,400	17,300		
55	17,800	16,600			18,100	17,200			17,400	17,300		
60	17,800	15,800	13,000		18,100	16,500	13,300		17,400	17,100		
65	17,800	15,200	12,600		18,100	15,800	12,900		17,400	16,400	13,100	
70	17,800	14,500	12,100	10,600	18,100	15,100	12,500		17,400	15,700	12,700	
75	16,900	13,900	11,700	10,400	18,000	14,500	12,100	10,500	17,400	15,200	12,400	10,700
80	16,100	13,400	11,400	10,100	17,200	14,000	11,700	10,300	17,400	14,600	12,000	10,500
85	15,300	12,900	11,000	9,900	16,400	13,500	11,400	10,100	17,400	14,100	11,700	10,200
90	14,600	12,400	10,700	9,700	15,700	13,000	11,100	9,900	16,600	13,600	11,400	10,000
95	14,000	12,000	10,400	9,400	15,000	12,600	10,800	9,600	14,800	13,200	11,100	9,800
100	13,400	11,500	10,100	9,300	14,400	12,200	10,500	9,500	13,200	12,700	10,800	9,600
105	12,800	11,200	9,900	9,100	13,200	11,800	10,200	9,300	11,800	12,400	10,600	9,500
110	12,300	10,800	9,600	8,900	11,900	11,400	10,000	9,100	10,600	11,800	10,300	9,300
115	11,700	10,500	9,400	8,800	10,800	11,100	9,700	9,000	9,500	10,600	10,100	9,200
120	10,700	10,200	9,200	8,600	9,800	10,700	9,500	8,800	8,400	9,500	9,900	9,000
125	9,800	9,900	9,000	8,500	8,800	9,700	9,300	8,700	7,500	8,500	9,600	8,900
130	8,900	9,600	8,800	8,400	8,000	8,800	9,100	8,600	6,700	7,600	8,600	8,800
135	8,100	8,700	8,600	8,300	7,200	7,900	8,700	8,500	5,900	6,800	7,700	8,300
140	7,400	8,000	8,500	8,200	6,500	7,200	7,800	8,200	5,200	6,000	6,800	7,400
145	6,700	7,200	7,700	7,900	5,800	6,400	7,000	7,400	4,500	5,300	6,000	6,500
150	6,100	6,600	7,000	7,100	5,200	5,800	6,300	6,600	3,900	4,600	5,300	5,700
155	5,600	5,900	6,300		4,600	5,100	5,600	5,800	3,300	4,000	4,600	5,000
160	5,000	5,400	5,600		4,100	4,600	5,000	5,100	2,800	3,400	4,000	4,300
165	4,500	4,800	5,000		3,600	4,000	4,400		2,300	2,900	3,400	3,600
170	4,100	4,300			3,100	3,500	3,800			2,400	2,800	3,000
175					2,700	3,000	3,200				2,300	2,400
180					2,300	2,600	2,700					
185						2,100						
Min Angle	14.5	17.5	25.0	13.0	22.0	22.5	24.5	17.0	40.0	41.0	41.0	41.0
Max Rad.	175.0	175.0	170.0	162.0	183.8	186.3	185.0	178.1	168.0	174.0	178.0	178.3
Capacity	0	0	0	0	0	0	0	0	0	0	0	0

1031090



PORTLAND OFFICE: 503.283.3111
 SEATTLE OFFICE: 206.784.1054
WWW.NESSCAMPBELL.COM

Rated Lifting Capacities in Pounds

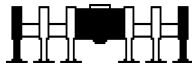

Full

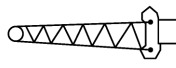

67ft Offset Fly



36,000 lbs



Radius (ft)	Boom Length (ft)			
	Fly Offset			
	168.5			
	2°	15°	30°	45°
35	15,300			
40	15,300			
45	15,300			
50	15,300			
55	15,300	15,200		
60	15,300	15,200		
65	15,300	15,200		
70	15,300	15,200	13,000	
75	15,300	15,200	12,600	
80	15,300	15,200	12,300	
85	15,300	14,600	12,000	10,400
90	15,300	14,200	11,700	10,200
95	13,600	13,700	11,400	10,000
100	12,100	13,300	11,100	9,800
105	10,700	12,200	10,900	9,600
110	9,400	10,800	10,600	9,500
115	8,300	9,600	10,400	9,300
120	7,300	8,500	9,800	9,200
125	6,400	7,500	8,700	9,100
130	5,500	6,600	7,700	8,500
135	4,800	5,800	6,800	7,500
140	4,000	5,000	5,900	6,600
145	3,400	4,300	5,200	5,800
150	2,800	3,600	4,400	5,000
155	2,200	3,000	3,700	4,200
160		2,400	3,100	3,600
165			2,500	2,900
170				2,300
Min Angle	49.5	50.5	50.5	51.0
Max Rad.	157.0	164.0	170.0	172.5
Capacity	0	0	0	0

1031090



PORTLAND OFFICE: 503.283.3111
 SEATTLE OFFICE: 206.784.1054
WWW.NESSCAMPBELL.COM

Rated Lifting Capacities in Pounds

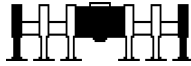

Full

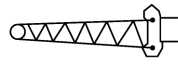

67ft Hydraulic Offset Fly



36,000 lbs



Radius (ft)	Boom Length (ft)											
	Fly Offset											
	44.3			73.5			103.8			134.9		
	2°-15°	15°-30°	30°-45°	2°-15°	15°-30°	30°-45°	2°-15°	15°-30°	30°-45°	2°-15°	15°-30°	30°-45°
15	30,000											
20	27,800			27,500								
25	19,800	19,800		27,500			18,200					
30	18,100	18,100		19,900	19,900		18,200			15,900		
35	16,600	16,600		18,500	18,500		18,200			15,900		
40	15,400	13,700	13,700	17,300	17,300		18,100	18,100		15,900		
45	14,300	12,800	12,800	16,200	13,700	13,700	17,700	17,700		15,800	15,800	
50	13,300	12,100	11,100	15,300	13,100	13,100	16,800	13,800	13,800	15,800	15,800	
55	12,500	11,400	10,600	14,400	12,400	11,100	15,900	13,200	13,200	15,800	15,800	
60	11,700	10,800	10,100	13,600	11,900	10,700	15,200	12,700	12,700	15,800	13,300	13,300
65	11,100	10,300	9,700	12,900	11,400	10,300	14,500	12,200	10,800	15,800	12,900	12,900
70	10,500	9,800	9,300	12,300	10,900	10,000	13,800	11,800	10,500	15,100	12,400	10,800
75	9,900	9,300	8,900	11,700	10,500	9,700	13,200	11,400	10,200	14,500	12,100	10,500
80	9,400	8,900	8,600	11,200	10,100	9,400	12,700	11,000	9,900	14,000	11,700	10,300
85	9,000	8,600	8,400	10,700	9,800	9,100	12,200	10,600	9,700	13,500	11,400	10,100
90	8,600	8,300	8,200	10,300	9,400	8,900	11,700	10,300	9,400	13,000	11,100	9,800
95	8,200	8,000	8,000	9,900	9,100	8,700	11,300	10,000	9,200	12,600	10,800	9,600
100	7,900	7,900		9,500	8,900	8,500	10,900	9,700	9,000	12,100	10,500	9,500
105				9,100	8,600	8,300	10,500	9,500	8,900	11,700	10,200	9,300
110				8,800	8,400	8,200	10,200	9,200	8,700	11,400	10,000	9,100
115				8,500	8,200	8,200	9,800	9,000	8,500	11,000	9,700	9,000
120				8,300	8,000	8,000	9,500	8,800	8,400	10,200	9,500	8,800
125				8,100	8,000	8,000	9,300	8,600	8,300	9,300	9,300	8,700
130							9,000	8,400	8,200	8,400	9,100	8,600
135							8,700	8,300	8,200	7,600	8,300	8,500
140							8,000	8,200	8,200	6,900	7,500	8,200
145							7,400	7,700	8,000	6,200	6,800	7,400
150							6,700	7,000		5,600	6,200	6,700
155							6,200			5,000	5,500	6,000
160										4,500	5,000	5,300
165										4,000	4,400	4,700
170										3,600	3,900	4,200
175										3,100	3,400	3,500
180										2,700	3,000	
185										2,400		
Min Angle	0.0	0.0	0.0	14.0	18.5	0.0	14.0	26.0	11.5	15.5	24.5	17.0
Max Rad.	102.9	102.7	100.7	130.0	130.0	128.9	160.0	155.0	146.4	190.0	185.0	177.6
Capacity	6,200	6,400	7,000	0	0	2,000	0	0	0	0	0	0

1032070



PORTLAND OFFICE: 503.283.3111
 SEATTLE OFFICE: 206.784.1054
WWW.NESSCAMPBELL.COM

Rated Lifting Capacities in Pounds

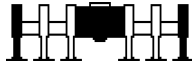

Full

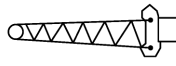

67ft Hydraulic Offset Fly



36,000 lbs



Radius (ft)	Boom Length (ft)								
	Fly Offset								
	167.1			183.6			200.1		
	2°-15°	15°-30°	30°-45°	2°-15°	15°-30°	30°-45°	2°-15°	15°-30°	30°-45°
35	13,300								
40	13,300			12,400					
45	13,300			12,400			10,800		
50	13,200	13,200		12,400			10,800		
55	13,200	13,200		12,300	12,300		10,800		
60	13,200	13,200		12,300	12,300		10,800	10,800	
65	13,200	13,200	13,200	12,300	12,300		10,800	10,800	
70	13,200	13,000	13,000	12,300	12,200	12,200	10,800	10,800	
75	13,200	12,600	12,600	12,300	12,200	12,200	10,800	10,700	10,700
80	13,200	12,300	10,600	12,300	12,200	12,200	10,800	10,700	10,700
85	13,200	12,000	10,400	12,300	12,200	10,500	10,800	10,700	10,700
90	13,200	11,600	10,200	12,300	11,900	10,300	10,800	10,700	10,400
95	13,200	11,400	10,000	12,300	11,600	10,100	10,800	10,700	10,300
100	13,200	11,100	9,800	12,300	11,400	10,000	10,800	10,700	10,100
105	12,000	10,800	9,600	10,900	11,100	9,800	9,900	10,700	9,900
110	10,800	10,600	9,500	9,700	10,900	9,600	8,700	10,200	9,800
115	9,600	10,400	9,300	8,600	9,900	9,500	7,600	9,000	9,600
120	8,600	9,700	9,200	7,500	8,800	9,300	6,600	7,900	9,300
125	7,700	8,700	9,000	6,600	7,800	9,000	5,700	6,900	8,200
130	6,800	7,800	8,800	5,800	6,900	8,000	4,800	6,000	7,200
135	6,100	7,000	7,900	5,000	6,000	7,000	4,000	5,200	6,300
140	5,300	6,200	7,000	4,300	5,200	6,200	3,300	4,400	5,500
145	4,700	5,500	6,300	3,600	4,500	5,400	2,700	3,700	4,700
150	4,100	4,800	5,500	3,000	3,900	4,700	2,100	3,000	4,000
155	3,500	4,200	4,900	2,400	3,200	4,000		2,400	3,300
160	3,000	3,600	4,200		2,700	3,400			2,700
165	2,500	3,100	3,600		2,100	2,800			2,100
170		2,600	3,100			2,300			
175		2,100	2,600						
180			2,100						
Min Angle	45.0	45.5	46.0	53.0	53.5	54.0	58.5	59.0	59.5
Max Rad. Capacity	170.0	176.3	181.0	159.0	166.0	172.5	150.8	158.3	165.8
	0	0	0	0	0	0	0	0	0

1032070



PORTLAND OFFICE: 503.283.3111
 SEATTLE OFFICE: 206.784.1054
WWW.NESSCAMPBELL.COM

Rated Lifting Capacities in Pounds

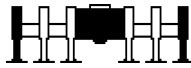

Full

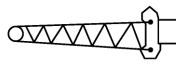

67ft Hydraulic Offset Fly



36,000 lbs



Boom Length (ft)												
Fly Offset												
Radius (ft)	44.3			58.9			89.1			120.3		
	2°-15°	15°-30°	30°-45°	2°-15°	15°-30°	30°-45°	2°-15°	15°-30°	30°-45°	2°-15°	15°-30°	30°-45°
15	30,000											
20	27,800			30,300			28,400					
25	19,800	19,800		26,900			28,400			19,500		
30	18,100	18,100		19,100	19,100		28,100			19,500		
35	16,600	16,600		17,700	17,700		19,300	19,300		19,500		
40	15,400	13,700	13,700	16,400	14,100	14,100	18,100	18,100		19,400	19,400	
45	14,300	12,800	12,800	15,300	13,300	13,300	17,000	14,100	14,100	18,400	18,400	
50	13,300	12,100	11,100	14,400	12,600	12,600	16,100	13,400	13,400	17,500	17,500	
55	12,500	11,400	10,600	13,500	12,000	10,900	15,200	12,900	12,900	16,600	13,500	13,500
60	11,700	10,800	10,100	12,700	11,400	10,400	14,500	12,300	10,900	15,900	13,000	13,000
65	11,100	10,300	9,700	12,100	10,900	10,000	13,800	11,800	10,600	15,200	12,600	10,900
70	10,500	9,800	9,300	11,400	10,400	9,700	13,100	11,400	10,300	14,500	12,200	10,700
75	9,900	9,300	8,900	10,900	10,000	9,300	12,500	11,000	10,000	14,000	11,800	10,400
80	9,400	8,900	8,600	10,400	9,600	9,000	12,000	10,600	9,700	13,400	11,400	10,100
85	9,000	8,600	8,400	9,900	9,200	8,800	11,500	10,200	9,400	12,900	11,100	9,900
90	8,600	8,300	8,200	9,500	8,900	8,600	11,100	9,900	9,200	12,400	10,700	9,700
95	8,200	8,000	8,000	9,100	8,600	8,400	10,600	9,600	9,000	12,000	10,400	9,500
100	7,900	7,900		8,700	8,300	8,200	10,200	9,300	8,800	11,600	10,200	9,300
105				8,400	8,100	8,100	9,900	9,100	8,600	11,200	9,900	9,100
110				8,100	8,000	8,000	9,500	8,800	8,500	10,800	9,600	8,900
115				7,900	7,900		9,200	8,600	8,300	10,500	9,400	8,800
120							8,900	8,400	8,200	10,000	9,200	8,600
125							8,700	8,300	8,200	9,100	9,000	8,500
130							8,400	8,100	8,100	8,200	8,800	8,400
135							8,200	8,000	8,000	7,500	8,100	8,300
140							8,000	8,000	8,000	6,700	7,300	7,900
145							7,300	7,500		6,100	6,600	7,100
150										5,500	5,900	6,400
155										4,900	5,300	5,700
160										4,400	4,700	4,900
165										3,900	4,200	
170										3,400		
Min Angle	0.0	0.0	0.0	0.0	0.0	0.0	0.0	0.0	0.0	15.5	26.0	3.5
Max Rad.	102.9	102.7	100.7	117.5	117.1	114.7	147.7	147.1	144.1	175.0	170.0	163.0
Capacity	6,200	6,400	7,000	3,600	3,700	4,100	2,600	2,600	2,900	0	0	0

1032080



PORTLAND OFFICE: 503.283.3111
 SEATTLE OFFICE: 206.784.1054
WWW.NESSCAMPBELL.COM

Rated Lifting Capacities in Pounds

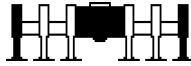

Full

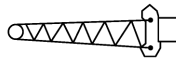

67ft Hydraulic Offset Fly



36,000 lbs



Radius (ft)	Boom Length (ft)								
	Fly Offset								
	152.4			169.0			185.5		
	2°-15°	15°-30°	30°-45°	2°-15°	15°-30°	30°-45°	2°-15°	15°-30°	30°-45°
35	16,600			15,500					
40	16,600			15,500			13,500		
45	16,600			15,500			13,500		
50	16,500	16,500		15,400	15,400		13,500		
55	16,500	16,500		15,400	15,400		13,500	13,500	
60	16,500	16,500		15,400	15,400		13,500	13,500	
65	16,400	13,100	13,100	15,400	13,400	13,400	13,500	13,500	
70	15,800	12,700	12,700	15,400	13,000	13,000	13,500	13,200	13,200
75	15,200	12,400	10,700	15,400	12,600	12,600	13,500	12,900	12,900
80	14,600	12,000	10,500	15,200	12,300	10,600	13,500	12,500	12,500
85	14,100	11,700	10,200	14,700	12,000	10,400	13,500	12,200	10,500
90	13,600	11,400	10,000	14,200	11,700	10,200	13,500	11,900	10,300
95	13,200	11,100	9,800	13,600	11,400	10,000	12,500	11,700	10,100
100	12,800	10,800	9,700	12,000	11,100	9,800	11,000	11,400	10,000
105	11,800	10,600	9,500	10,600	10,900	9,700	9,600	11,100	9,800
110	10,500	10,300	9,300	9,400	10,600	9,500	8,400	9,900	9,600
115	9,400	10,100	9,200	8,300	9,600	9,300	7,300	8,700	9,500
120	8,400	9,500	9,000	7,300	8,500	9,200	6,300	7,600	9,000
125	7,500	8,500	8,900	6,300	7,500	8,700	5,300	6,600	7,900
130	6,600	7,600	8,500	5,500	6,600	7,700	4,500	5,700	6,900
135	5,800	6,700	7,600	4,700	5,700	6,700	3,700	4,900	6,000
140	5,100	5,900	6,800	4,000	5,000	5,900	3,000	4,100	5,200
145	4,400	5,200	6,000	3,300	4,200	5,100	2,400	3,400	4,400
150	3,800	4,600	5,200	2,700	3,600	4,400		2,700	3,600
155	3,300	3,900	4,600	2,200	3,000	3,700		2,100	3,000
160	2,700	3,400	3,900		2,400	3,100			2,300
165	2,200	2,800	3,300			2,500			
170		2,300	2,800						
175			2,200						
Min Angle	41.0	42.0	42.0	50.0	50.5	51.5	56.5	57.0	57.5
Max Rad.	167.5	173.0	177.0	156.7	163.3	169.2	148.3	155.8	162.5
Capacity	0	0	0	0	0	0	0	0	0

1032080



PORTLAND OFFICE: 503.283.3111
 SEATTLE OFFICE: 206.784.1054
WWW.NESSCAMPBELL.COM

Rated Lifting Capacities in Pounds

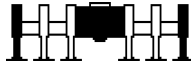

Full

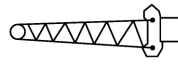

67ft Hydraulic Offset Fly



36,000 lbs



Boom Length (ft)												
Fly Offset												
Radius (ft)	44.3			73.5			103.8			119.4		
	2°-15°	15°-30°	30°-45°	2°-15°	15°-30°	30°-45°	2°-15°	15°-30°	30°-45°	2°-15°	15°-30°	30°-45°
15	30,000											
20	27,800			27,500								
25	19,800	19,800		27,500			18,200					
30	18,100	18,100		19,900	19,900		18,200			17,800		
35	16,600	16,600		18,500	18,500		18,200			17,800		
40	15,400	13,700	13,700	17,300	17,300		18,100	18,100		17,700	17,700	
45	14,300	12,800	12,800	16,200	13,700	13,700	17,700	17,700		17,700	17,700	
50	13,300	12,100	11,100	15,300	13,100	13,100	16,800	13,800	13,800	17,400	17,400	
55	12,500	11,400	10,600	14,400	12,400	11,100	15,900	13,200	13,200	16,600	13,500	13,500
60	11,700	10,800	10,100	13,600	11,900	10,700	15,200	12,700	12,700	15,800	13,000	13,000
65	11,100	10,300	9,700	12,900	11,400	10,300	14,500	12,200	10,800	15,200	12,600	12,600
70	10,500	9,800	9,300	12,300	10,900	10,000	13,800	11,800	10,500	14,500	12,100	10,600
75	9,900	9,300	8,900	11,700	10,500	9,700	13,200	11,400	10,200	13,900	11,700	10,400
80	9,400	8,900	8,600	11,200	10,100	9,400	12,700	11,000	9,900	13,400	11,400	10,100
85	9,000	8,600	8,400	10,700	9,800	9,100	12,200	10,600	9,700	12,900	11,000	9,900
90	8,600	8,300	8,200	10,300	9,400	8,900	11,700	10,300	9,400	12,400	10,700	9,700
95	8,200	8,000	8,000	9,900	9,100	8,700	11,300	10,000	9,200	12,000	10,400	9,400
100	7,900	7,900		9,500	8,900	8,500	10,900	9,700	9,000	11,500	10,100	9,300
105				9,100	8,600	8,300	10,500	9,500	8,900	11,200	9,900	9,100
110				8,800	8,400	8,200	10,200	9,200	8,700	10,800	9,600	8,900
115				8,500	8,200	8,200	9,800	9,000	8,500	10,500	9,400	8,800
120				8,300	8,000	8,000	9,500	8,800	8,400	10,200	9,200	8,600
125				8,100	8,000	8,000	9,300	8,600	8,300	9,800	9,000	8,500
130							9,000	8,400	8,200	8,900	8,800	8,400
135							8,700	8,300	8,200	8,100	8,600	8,300
140							8,000	8,200	8,200	7,400	8,000	8,200
145							7,400	7,700	8,000	6,700	7,200	7,700
150							6,700	7,000		6,100	6,600	7,000
155							6,200			5,600	5,900	6,300
160										5,000	5,400	5,500
165										4,500	4,800	
170										4,100		
Min Angle	0.0	0.0	0.0	14.0	18.5	0.0	14.0	26.0	11.5	14.5	25.0	13.0
Max Rad.	102.9	102.7	100.7	130.0	130.0	128.9	160.0	155.0	146.4	175.0	170.0	162.0
Capacity	6,200	6,400	7,000	0	0	2,000	0	0	0	0	0	0

1032090



PORTLAND OFFICE: 503.283.3111
 SEATTLE OFFICE: 206.784.1054
WWW.NESSCAMPBELL.COM

Rated Lifting Capacities in Pounds

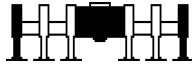

Full

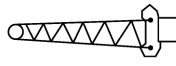

67ft Hydraulic Offset Fly



36,000 lbs



Boom Length (ft)									
Fly Offset									
Radius (ft)	135.4			152.0			168.5		
	2°-15°	15°-30°	30°-45°	2°-15°	15°-30°	30°-45°	2°-15°	15°-30°	30°-45°
35	18,100			17,400			15,300		
40	18,100			17,400			15,300		
45	18,000	18,000		17,400			15,300		
50	18,000	18,000		17,300	17,300		15,200	15,200	
55	17,200	17,200		17,300	17,300		15,200	15,200	
60	16,500	13,300	13,300	17,100	17,100		15,200	15,200	
65	15,800	12,900	12,900	16,400	13,100	13,100	15,200	15,200	
70	15,100	12,500	12,500	15,700	12,700	10,900	15,200	13,000	13,000
75	14,500	12,100	10,500	15,200	12,400	10,700	15,200	12,600	12,600
80	14,000	11,700	10,300	14,600	12,000	10,500	15,200	12,300	10,600
85	13,500	11,400	10,100	14,100	11,700	10,200	14,600	12,000	10,400
90	13,000	11,100	9,900	13,600	11,400	10,000	14,200	11,700	10,200
95	12,600	10,800	9,600	13,200	11,100	9,800	13,600	11,400	10,000
100	12,200	10,500	9,500	12,700	10,800	9,600	12,100	11,100	9,800
105	11,800	10,200	9,300	11,800	10,600	9,500	10,700	10,900	9,600
110	11,400	10,000	9,100	10,600	10,300	9,300	9,400	10,600	9,500
115	10,800	9,700	9,000	9,500	10,100	9,200	8,300	9,600	9,300
120	9,800	9,500	8,800	8,400	9,500	9,000	7,300	8,500	9,200
125	8,800	9,300	8,700	7,500	8,500	8,900	6,400	7,500	8,700
130	8,000	8,800	8,600	6,700	7,600	8,600	5,500	6,600	7,700
135	7,200	7,900	8,500	5,900	6,800	7,700	4,800	5,800	6,800
140	6,500	7,200	7,800	5,200	6,000	6,800	4,000	5,000	5,900
145	5,800	6,400	7,000	4,500	5,300	6,000	3,400	4,300	5,200
150	5,200	5,800	6,300	3,900	4,600	5,300	2,800	3,600	4,400
155	4,600	5,100	5,600	3,300	4,000	4,600	2,200	3,000	3,700
160	4,100	4,600	5,000	2,800	3,400	4,000		2,400	3,100
165	3,600	4,000	4,400	2,300	2,900	3,400			2,500
170	3,100	3,500	3,800		2,400	2,800			
175	2,700	3,000	3,200			2,300			
180	2,300	2,600							
Min Angle	22.0	24.5	17.0	40.0	41.0	41.0	49.5	50.5	50.5
Max Rad. Capacity	183.8	185.0	178.1	168.0	174.0	178.0	157.0	164.0	170.0
	0	0	0	0	0	0	0	0	0

1032090



PORTLAND OFFICE: 503.283.3111
 SEATTLE OFFICE: 206.784.1054
WWW.NESSCAMPBELL.COM

Rated Lifting Capacities in Pounds

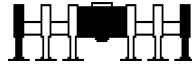

Full



58,000 lbs



Boom Length (ft)											
Extend Mode											
Radius (ft)	44.3	58.9	59.4	59.9	73.5	74.0	75.0	75.9	88.7	89.1	89.6
	ALL	EM2, EM5	EM6	EM7	EM1, EM3, EM4	EM5	EM6	EM7	EM4	EM2	EM5
10	288,300	195,200	289,400	288,500	134,800	196,100	247,000	262,200	125,300	120,100	168,700
12	259,500	182,900	261,200	260,400	125,600	182,200	228,300	256,800	117,000	112,200	168,700
15	224,000	167,200	226,300	225,500	114,000	164,700	205,000	224,900	106,200	102,000	161,600
20	175,400	146,500	179,400	178,100	98,600	141,800	175,200	178,100	91,900	88,500	140,000
25	137,700	130,500	141,900	140,600	86,700	124,400	143,100	140,900	80,800	78,000	123,300
30	111,900	117,200	116,200	115,000	75,900	110,800	117,600	115,400	72,100	69,600	110,000
35	93,100	98,500	97,500	96,300	67,200	99,800	98,900	96,800	65,000	62,800	99,200
40		80,700	79,400	77,900	60,000	83,200	80,900	78,100	59,100	57,100	83,600
45		65,600	64,400	63,000	54,100	68,300	66,200	63,500	54,100	51,700	68,700
50		54,600	53,400	52,100	49,300	57,300	55,300	52,800	49,900	47,100	57,700
55					45,200	48,800	46,900	44,500	46,200	43,300	49,400
60					41,900	42,100	40,200	37,900	43,100	39,900	42,800
65						36,700	34,900	32,600	38,900	37,000	37,400
70									34,500	33,800	33,000
75									30,700	30,000	29,200
80									25,000	26,900	26,000
Unpinned		101,200	89,600	80,400	55,600	95,600	89,600	72,800	98,200	56,000	83,900
Min Angle	0.0	0.0	0.0	0.0	0.0	0.0	0.0	0.0	0.0	0.0	0.0
Max Rad. Capacity	35.7	50.4	50.8	51.3	65.0	65.5	66.4	67.4	80.1	80.6	81.1
Capacity	66,600	22,600	48,400	47,000	12,200	19,400	33,600	30,400	10,700	16,400	16,100

1040010



PORTLAND OFFICE: 503.283.3111
 SEATTLE OFFICE: 206.784.1054
WWW.NESSCAMPBELL.COM

Rated Lifting Capacities in Pounds

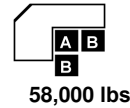
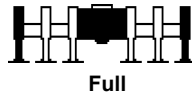

Radius (ft)	Boom Length (ft)											
	Extend Mode											
	91.0	92.5	103.8	104.2	105.7	107.6	119.4	120.3	120.3	122.2	124.1	134.9
	EM6	EM7	EM1, EM3	EM4	EM5	EM6	EM3	EM4	EM2	EM5	EM6	EM1
10	212,200	203,700										
12	212,200	203,700										
15	198,500	203,700	84,300	100,600	128,900							
20	169,700	176,400	76,600	97,200	128,900	172,300	66,300	92,800	77,300	120,900	129,700	54,700
25	142,600	139,500	67,600	86,600	124,700	140,900	66,300	91,000	69,400	120,900	112,800	54,700
30	117,300	114,200	60,300	78,100	111,500	115,800	64,000	82,700	62,100	117,400	99,400	54,700
35	98,700	95,700	54,400	71,000	100,600	97,400	58,200	75,900	56,200	99,100	88,400	52,400
40	80,400	76,500	49,500	65,000	82,700	78,600	53,300	70,000	51,200	80,800	77,300	47,800
45	65,700	62,000	45,300	60,000	67,900	64,000	48,900	64,900	46,900	66,100	62,800	43,800
50	54,900	51,500	41,700	55,700	56,900	53,200	45,100	58,400	43,200	55,200	52,000	40,400
55	46,700	43,300	38,700	51,100	48,700	45,200	41,800	50,200	40,000	47,000	44,000	37,400
60	40,200	36,900	36,000	44,400	42,100	38,700	38,900	43,500	37,200	40,500	37,600	34,800
65	34,800	31,700	33,400	39,000	36,800	33,600	36,400	38,200	34,700	35,200	32,500	32,400
70	30,400	27,300	31,000	34,700	32,500	29,200	34,100	33,900	32,500	31,000	28,200	30,400
75	26,700	23,600	28,900	30,900	28,800	25,600	31,600	30,200	30,500	27,300	24,600	28,500
80	23,500	20,500	27,100	27,700	25,600	22,400	28,400	27,000	27,300	24,200	21,500	26,800
85			25,400	24,900	22,800	19,700	25,600	24,300	24,500	21,500	18,900	25,300
90			23,200	22,500	20,400	17,300	23,200	21,900	22,100	19,100	16,600	23,200
95			21,100	20,400	18,300	15,300	21,100	19,700	20,000	17,200	14,600	21,100
100							19,200	17,900	18,100	15,300	12,700	19,200
105							17,500	16,300	16,600	13,600	11,100	17,500
110							16,100	14,800	15,100	12,200	9,600	16,100
115											8,300	14,800
120												13,500
125												12,400
Unpinned	74,300	60,200	60,700	86,100	75,900	61,400	66,300	77,900	60,700	61,800	44,600	54,700
Min Angle	0.0	0.0	0.0	0.0	0.0	0.0	0.0	0.0	0.0	0.0	0.0	0.0
Max Rad.	82.5	83.9	95.2	95.7	97.1	99.0	110.8	111.7	111.8	113.7	115.6	126.4
Capacity	22,200	18,400	9,400	9,100	12,800	13,800	7,900	7,300	11,300	9,500	8,200	6,700

1040010



PORTLAND OFFICE: 503.283.3111
 SEATTLE OFFICE: 206.784.1054
WWW.NESSCAMPBELL.COM

Rated Lifting Capacities in Pounds

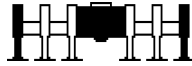

Full



58,000 lbs



Boom Length (ft)											
Extend Mode											
Radius (ft)	135.4	136.8	152.0	152.4	153.4	167.1	168.5	169.0	183.6	185.5	200.1
	EM3	EM4	EM3	EM2	EM4	EM1	EM3	EM2	EM1	EM2	EM1
20	65,600	91,400									
25	65,600	91,400	65,300	57,200	73,000	41,200					
30	65,600	85,500	65,300	57,200	73,000	41,200	55,000	53,300	38,700	41,300	
35	61,700	79,100	64,100	54,500	73,000	41,200	55,000	53,300	38,700	41,300	33,000
40	57,000	73,500	59,600	49,800	69,700	41,200	55,000	52,200	38,700	41,300	33,000
45	52,800	67,600	55,600	45,700	63,800	41,200	55,000	48,200	38,700	41,300	33,000
50	49,100	56,700	52,100	41,900	55,300	40,500	53,500	44,300	38,700	41,300	33,000
55	45,800	48,500	48,900	38,800	47,200	37,600	47,900	41,300	38,700	41,300	33,000
60	42,700	41,900	42,600	36,000	40,600	34,900	41,400	38,500	37,200	40,200	33,000
65	38,800	36,600	37,300	33,600	35,300	32,500	36,000	36,000	34,800	35,000	33,000
70	34,500	32,400	33,100	31,300	31,200	30,400	31,900	31,800	32,700	30,900	31,800
75	30,800	28,700	29,400	29,300	27,500	28,500	28,200	28,100	29,000	27,200	28,100
80	27,600	25,500	26,200	26,100	24,400	26,700	25,100	25,000	25,900	24,100	24,900
85	24,900	22,800	23,500	23,400	21,700	24,300	22,400	22,300	23,200	21,400	22,200
90	22,500	20,500	21,100	21,100	19,300	21,900	20,000	20,000	20,800	19,000	19,900
95	20,400	18,400	19,100	19,000	17,300	19,800	18,000	17,900	18,700	17,000	17,800
100	18,500	16,700	17,200	17,200	15,700	18,000	16,400	16,300	17,100	15,400	16,300
105	17,000	15,000	15,800	15,700	14,000	16,600	14,700	14,700	15,500	13,800	14,600
110	15,500	13,500	14,300	14,200	12,600	15,100	13,300	13,200	14,100	12,300	13,200
115	14,100	12,200	12,900	12,900	11,200	13,800	11,900	11,900	12,700	11,000	11,900
120	12,900	11,000	11,700	11,600	10,000	12,500	10,700	10,700	11,500	9,800	10,700
125	11,800	9,900	10,600	10,500	8,900	11,400	9,600	9,600	10,400	8,800	9,600
130			9,600	9,500	7,900	10,400	8,600	8,500	9,400	7,800	8,600
135			8,600	8,600	7,000	9,400	7,700	7,600	8,500	6,800	7,700
140			7,800	7,700	6,100	8,600	6,800	6,800	7,600	6,000	6,800
145						7,800	6,000	6,000	6,800	5,200	6,000
150						7,100	5,300	5,200	6,100	4,500	5,300
155						6,400	4,600	4,600	5,400	3,800	4,600
160								4,000	4,800	3,200	4,000
165									4,200	2,600	3,400
170									3,700		2,800
175											2,300
Unpinned	65,600	63,400	65,200	57,200	63,200	41,200	55,000	53,300	38,700	41,300	33,000
Min Angle	0.0	0.0	0.0	0.0	0.0	0.0	0.0	0.0	0.0	20.0	25.0
Max Rad.	126.9	128.3	143.4	143.9	144.8	158.5	159.9	160.4	175.1	170.0	178.8
Capacity	6,400	5,300	4,500	7,000	3,500	4,000	2,900	3,900	2,500	0	0

1040010



PORTLAND OFFICE: 503.283.3111
 SEATTLE OFFICE: 206.784.1054
WWW.NESSCAMPBELL.COM

Rated Lifting Capacities in Pounds

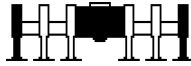

Full

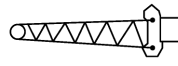

12ft Offset Fly
2° - 45°



58,000 lbs



360°

Boom Length (ft)											
Extend Mode											
Radius (ft)	44.3	58.9	59.4	59.9	73.5	74.0	75.0	75.9	88.7	89.1	89.6
	ALL	EM2, EM5	EM6	EM7	EM1, EM3, EM4	EM5	EM6	EM7	EM4	EM2	EM5
10	69,600	69,500	69,500	69,500	69,400	69,400	69,400	69,400	69,400	69,400	69,300
12	69,600	69,500	69,500	69,500	69,400	69,400	69,400	69,400	69,400	69,400	69,300
15	69,600	69,500	69,500	69,500	69,400	69,400	69,400	69,400	69,400	69,400	69,300
20	69,600	69,500	69,500	69,500	69,400	69,400	69,400	69,400	69,400	69,400	69,300
25	69,600	69,500	69,500	69,500	69,400	69,400	69,400	69,400	69,400	69,400	69,300
30	66,700	69,500	69,500	69,500	64,100	69,400	69,400	69,400	63,700	62,300	69,300
35	61,800	69,400	69,500	69,500	57,500	69,400	69,400	69,400	57,200	56,000	69,300
40	57,700	66,200	69,500	69,500	51,300	69,400	69,400	69,400	51,900	50,700	69,300
45	54,700	62,300	65,800	65,200	46,300	68,600	66,700	64,300	47,400	46,300	68,500
50		56,700	55,600	54,400	42,600	57,700	55,800	53,500	43,900	42,600	57,500
55		48,400	47,500	46,300	39,000	49,400	47,600	45,400	40,600	38,900	49,200
60		42,000	41,000	39,800	35,900	42,800	41,100	39,000	37,700	35,800	42,600
65					33,200	37,500	35,800	33,800	35,100	33,000	37,300
70					30,900	33,200	31,500	29,500	32,900	30,600	33,000
75					28,900	29,600	27,900	25,900	30,700	28,500	29,300
80									27,600	26,600	26,200
85									24,900	24,300	23,500
90									22,600	22,000	21,200
Unpinned		69,500	69,500	69,500	55,600	69,400	69,400	69,400	69,400	56,000	69,300
Min Angle	0.0	0.0	0.0	0.0	0.0	0.0	0.0	0.0	0.0	0.0	0.0
Max Rad.	46.4	61.0	61.5	61.9	75.6	76.1	77.0	78.0	90.7	91.2	91.7
Capacity	30,500	14,600	25,100	24,400	7,900	12,500	20,600	19,300	6,800	10,700	10,400

1043010



PORTLAND OFFICE: 503.283.3111
 SEATTLE OFFICE: 206.784.1054
WWW.NESSCAMPBELL.COM

Rated Lifting Capacities in Pounds

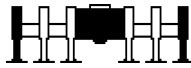

Full

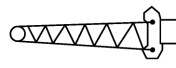

12ft Offset Fly
2° - 45°



58,000 lbs



360°

Radius (ft)	Boom Length (ft)											
	Extend Mode											
	91.0	92.5	103.8	104.2	105.7	107.6	119.4	120.3	120.3	122.2	124.1	134.9
	EM6	EM7	EM1, EM3	EM4	EM5	EM6	EM3	EM4	EM2	EM5	EM6	EM1
10	69,300	69,300										
12	69,300	69,300										
15	69,300	69,300	62,700	69,300	69,300	69,200	54,600	69,200	61,000	69,200	69,100	
20	69,300	69,300	62,700	69,300	69,300	69,200	54,600	69,200	61,000	69,200	69,100	42,600
25	69,300	69,300	61,800	69,300	69,300	69,200	54,600	69,200	61,000	69,200	69,100	42,600
30	69,300	69,300	55,000	68,300	69,300	69,200	54,600	69,200	58,300	69,200	69,100	42,600
35	69,300	69,300	49,400	62,100	69,300	69,200	52,600	66,100	52,500	69,200	69,100	42,600
40	69,300	69,300	45,000	56,700	69,300	69,200	48,000	60,800	47,700	69,200	69,100	42,600
45	65,700	62,300	41,100	52,100	67,400	63,700	44,300	56,200	43,700	65,400	62,200	41,000
50	54,900	51,700	37,700	48,200	56,400	53,000	40,900	52,200	40,100	54,500	51,700	37,700
55	46,700	43,600	34,800	45,000	48,200	44,900	37,900	48,700	37,000	46,400	43,500	34,800
60	40,200	37,100	32,200	42,000	41,600	38,400	35,300	42,700	34,300	39,800	37,100	32,200
65	34,900	32,100	30,000	38,400	36,300	33,300	33,000	37,400	31,900	34,600	32,000	29,900
70	30,700	27,800	27,900	34,100	32,100	29,000	31,000	33,100	29,700	30,400	27,700	27,900
75	27,000	24,200	25,900	30,400	28,400	25,400	29,100	29,400	27,800	26,700	24,100	26,000
80	23,900	21,100	24,200	27,200	25,200	22,300	27,400	26,300	26,000	23,600	21,100	24,400
85	21,300	18,500	22,600	24,500	22,600	19,600	24,800	23,500	23,800	20,900	18,400	22,900
90	19,000	16,300	21,500	22,100	20,200	17,300	22,400	21,200	21,400	18,600	16,300	21,700
95			20,100	20,100	18,200	15,400	20,400	19,100	19,400	16,700	14,300	20,100
100			18,900	18,300	16,500	13,700	18,500	17,300	17,500	14,900	12,500	18,200
105			17,400	16,800	14,900	12,100	17,000	15,800	16,000	13,300	10,900	16,800
110							15,600	14,300	14,600	11,900	9,500	15,300
115							14,200	13,000	13,300	10,600	8,200	14,000
120							13,100	11,900	12,100	9,400	7,100	12,800
125											6,000	11,700
130												10,700
135												9,800
Unpinned	69,300	60,200	60,700	69,300	69,300	61,400	54,600	69,200	60,700	61,800	44,600	42,600
Min Angle	0.0	0.0	0.0	0.0	0.0	0.0	0.0	0.0	0.0	0.0	0.0	0.0
Max Rad.	93.1	94.5	105.8	106.3	107.7	109.7	121.4	122.4	122.4	124.3	126.2	137.0
Capacity	16,000	14,000	5,900	5,600	8,100	10,900	4,800	4,200	7,200	5,700	5,900	3,800

1043010



PORTLAND OFFICE: 503.283.3111
SEATTLE OFFICE: 206.784.1054
WWW.NESSCAMPBELL.COM

Rated Lifting Capacities in Pounds

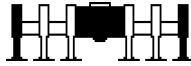

Full

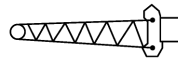

12ft Offset Fly
2° - 45°



58,000 lbs



360°

Boom Length (ft)											
Extend Mode											
Radius (ft)	135.4	136.8	152.0	152.4	153.4	167.1	168.5	169.0	183.6	185.5	200.1
	EM3	EM4	EM3	EM2	EM4	EM1	EM3	EM2	EM1	EM2	EM1
25	55,600	69,100	55,000	49,300	59,000	35,100	43,000	42,100			
30	55,600	69,100	55,000	49,100	59,000	35,100	43,000	42,100	32,900	35,400	
35	55,600	68,900	55,000	49,100	59,000	35,100	43,000	42,100	32,900	35,400	28,100
40	51,100	63,800	53,400	47,200	59,000	35,100	43,000	42,100	32,900	35,400	28,100
45	47,200	59,300	49,600	43,200	59,000	35,100	43,000	42,100	32,900	35,400	28,100
50	43,900	55,400	46,300	39,700	54,200	35,100	43,000	41,800	32,900	35,400	28,100
55	40,900	47,600	43,300	36,600	46,100	35,100	43,000	38,800	32,900	35,400	28,100
60	38,200	41,000	40,700	33,900	39,600	32,800	40,200	36,100	32,900	35,400	28,100
65	35,900	35,700	36,200	31,400	34,300	30,400	34,900	33,700	32,500	34,000	28,100
70	33,500	31,500	32,000	29,300	30,200	28,300	30,700	30,700	30,400	29,600	28,100
75	29,800	27,800	28,300	27,300	26,500	26,400	27,100	27,000	27,800	26,000	26,800
80	26,600	24,700	25,200	25,100	23,400	24,700	23,900	23,900	24,600	22,900	23,600
85	23,900	22,000	22,500	22,400	20,700	23,100	21,300	21,200	21,900	20,200	20,900
90	21,500	19,600	20,100	20,000	18,400	20,700	18,900	18,800	19,600	17,900	18,600
95	19,500	17,600	18,000	18,000	16,600	18,700	17,000	17,000	17,500	16,100	16,800
100	17,600	15,900	16,400	16,300	14,700	17,100	15,300	15,200	16,000	14,300	15,000
105	16,200	14,300	14,800	14,700	13,100	15,400	13,700	13,600	14,300	12,700	13,400
110	14,700	12,900	13,300	13,200	11,700	13,900	12,200	12,100	12,900	11,200	11,900
115	13,400	11,500	12,000	11,900	10,400	12,600	10,900	10,800	11,500	9,900	10,600
120	12,200	10,400	10,800	10,700	9,200	11,400	9,700	9,600	10,300	8,700	9,400
125	11,100	9,300	9,700	9,700	8,100	10,300	8,600	8,600	9,300	7,600	8,400
130	10,100	8,300	8,700	8,700	7,100	9,300	7,600	7,600	8,300	6,700	7,400
135	9,200	7,400	7,800	7,800	6,200	8,400	6,700	6,700	7,400	5,800	6,500
140			7,000	6,900	5,400	7,600	5,900	5,800	6,500	4,900	5,600
145			6,300	6,200	4,700	6,800	5,100	5,100	5,700	4,200	4,900
150				5,500	4,000	6,100	4,400	4,400	5,000	3,500	4,100
155						5,400	3,800	3,700	4,400	2,800	3,500
160						4,800	3,200	3,100	3,800	2,200	2,900
165							2,600	2,600	3,200		2,300
170								2,100	2,700		
175									2,200		
Unpinned	55,600	63,400	55,000	49,300	59,000	35,100	43,000	42,100	32,900	35,400	28,100
Min Angle	0.0	0.0	17.5	0.0	10.0	16.5	10.0	0.0	21.0	33.5	37.5
Max Rad.	137.5	138.9	150.0	154.5	155.0	165.0	170.0	171.0	177.0	161.7	168.0
Capacity	3,500	2,600	0	3,900	0	0	0	2,000	0	0	0

1043010



PORTLAND OFFICE: 503.283.3111
SEATTLE OFFICE: 206.784.1054
WWW.NESSCAMPBELL.COM

Rated Lifting Capacities in Pounds

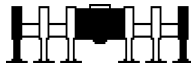

Full

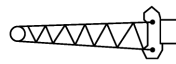

40ft Offset Fly



58,000 lbs



Radius (ft)	Boom Length (ft)											
	Fly Offset											
	44.3				73.5				103.8			
	2°	15°	30°	45°	2°	15°	30°	45°	2°	15°	30°	45°
10	34,700											
12	34,700				34,600							
15	34,700	34,700			34,600							
20	34,700	32,000			34,600	34,600			34,500			
25	33,900	28,800	24,900		34,600	32,900			34,500			
30	30,200	26,200	22,900	20,200	34,600	30,300	25,100		34,500	33,500		
35	27,200	24,000	20,700	19,000	34,500	28,100	23,600	20,300	34,500	31,400	25,200	
40	24,800	21,400	19,400	18,000	31,600	26,200	21,700	19,500	34,500	29,500	24,000	20,400
45	21,900	19,900	18,200	17,200	29,100	24,600	20,700	18,700	34,500	27,800	23,000	19,700
50	20,200	18,600	17,300	16,400	27,000	23,100	19,700	18,000	32,500	26,300	21,500	19,100
55	18,800	17,500	16,400	15,800	25,100	21,200	18,900	17,400	30,400	25,000	20,700	18,500
60	17,500	16,500	15,700	15,300	23,500	20,100	18,100	16,900	28,600	23,800	20,000	18,000
65	16,400	15,600	15,000	14,900	21,400	19,200	17,400	16,400	26,700	22,700	19,300	17,500
70	15,400	14,900	14,600		20,200	18,300	16,800	15,900	24,800	21,200	18,600	17,100
75	14,500	14,300			19,200	17,500	16,200	15,600	23,200	20,400	18,000	16,700
80					18,200	16,800	15,700	15,300	22,000	19,600	17,500	16,400
85					17,300	16,100	15,300	15,000	20,600	18,800	17,000	16,000
90					16,500	15,500	14,900		19,400	18,200	16,600	15,700
95					15,700	15,000	14,600		18,100	17,600	16,200	15,500
100					15,100	14,600			17,000	17,000	15,800	15,300
105					9,500				16,000	16,000	15,400	15,100
110									15,100	15,100	15,100	14,900
115									14,300	14,300	14,300	
120									13,500	13,500	13,500	
125									12,800	12,800	12,800	
130									12,200	12,200		
135									8,800			
Min Angle	0.0	0.0	0.0	0.0	0.0	0.0	0.0	0.0	0.0	0.0	0.0	0.0
Max Rad.	75.9	75.8	74.5	71.9	105.1	104.9	103.2	100.0	135.3	135.1	133.1	129.6
Capacity	11,200	11,400	12,100	13,600	3,700	3,700	3,900	4,200	2,600	2,600	2,700	2,900

1041040



PORTLAND OFFICE: 503.283.3111
 SEATTLE OFFICE: 206.784.1054
WWW.NESSCAMPBELL.COM

Rated Lifting Capacities in Pounds

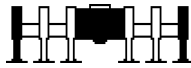

Full

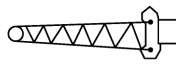

40ft Offset Fly



58,000 lbs



Radius (ft)	Boom Length (ft)											
	Fly Offset											
	134.9				167.1				183.6			
	2°	15°	30°	45°	2°	15°	30°	45°	2°	15°	30°	45°
25	29,700											
30	29,700				19,800							
35	29,700	29,500			19,800				18,600			
40	29,700	29,500			19,800	19,700			18,600			
45	29,700	29,500	24,300		19,800	19,700			18,600	18,500		
50	29,700	29,000	23,400	19,900	19,800	19,700	19,600		18,600	18,500		
55	29,700	27,700	22,100	19,300	19,800	19,700	19,600		18,600	18,500	18,300	
60	29,700	26,400	21,400	18,900	19,800	19,700	19,600	19,300	18,600	18,500	18,300	18,000
65	27,800	25,300	20,700	18,400	19,800	19,700	19,600	19,100	18,600	18,500	18,300	18,000
70	25,800	24,300	20,100	18,000	19,800	19,700	19,600	18,700	18,600	18,500	18,300	18,000
75	24,100	23,400	19,600	17,600	19,800	19,700	19,600	18,400	18,600	18,500	18,300	18,000
80	22,500	22,000	19,000	17,300	19,800	19,700	19,600	18,000	18,600	18,500	18,300	18,000
85	21,300	21,200	18,500	17,000	19,800	19,700	19,600	17,700	18,600	18,500	18,300	18,000
90	20,000	19,900	18,000	16,600	19,800	19,700	19,300	17,400	18,600	18,500	18,300	17,700
95	18,800	18,800	17,600	16,400	19,300	19,400	18,900	17,100	18,500	18,500	18,300	17,500
100	17,700	17,700	17,200	16,100	17,800	18,300	18,300	16,900	17,000	17,600	18,300	17,200
105	16,700	16,700	16,700	15,800	16,400	16,900	17,300	16,600	15,300	16,200	17,000	16,900
110	15,800	15,800	15,800	15,600	14,900	15,600	16,300	16,400	13,800	14,600	15,400	16,000
115	15,000	15,000	15,000	15,000	13,600	14,200	14,900	15,300	12,500	13,200	13,900	14,500
120	13,900	14,200	14,200	14,200	12,400	13,000	13,600	14,000	11,300	12,000	12,600	13,100
125	12,700	13,200	13,500	13,500	11,200	11,800	12,300	12,700	10,200	10,800	11,400	11,900
130	11,700	12,100	12,400	12,600	10,200	10,800	11,200	11,600	9,100	9,700	10,300	10,700
135	10,800	11,100	11,400	11,500	9,300	9,800	10,200	10,500	8,200	8,800	9,300	9,700
140	9,900	10,200	10,500		8,400	8,900	9,300	9,500	7,400	7,900	8,400	8,700
145	9,100	9,400	9,600		7,600	8,100	8,400	8,600	6,600	7,100	7,500	7,800
150	8,400	8,600	8,800		6,900	7,300	7,600	7,800	5,800	6,300	6,700	6,900
155	7,700	7,900	8,000		6,200	6,600	6,900	7,000	5,200	5,600	6,000	6,200
160	7,100	7,200			5,600	5,900	6,200	6,300	4,500	4,900	5,300	5,400
165					5,000	5,300	5,500		3,900	4,300	4,600	4,700
170					4,500	4,700	4,900		3,400	3,700	4,000	4,100
175					3,900	4,200	4,300		2,900	3,200	3,400	3,500
180					3,500	3,700	3,800		2,400	2,700	2,900	
185					3,000	3,200	3,200			2,200	2,400	
190					2,600	2,700						
Min Angle	12.5	14.0	22.5	4.0	15.5	17.0	14.5	19.0	35.5	35.5	35.5	35.5
Max Rad. Capacity	165.0	165.0	160.0	158.4	195.0	195.0	195.0	190.0	184.0	187.0	189.0	188.3
	0	0	0	0	0	0	0	0	0	0	0	0

1041040



PORTLAND OFFICE: 503.283.3111
 SEATTLE OFFICE: 206.784.1054
WWW.NESSCAMPBELL.COM

Rated Lifting Capacities in Pounds

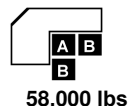
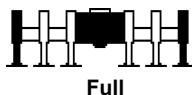

Radius (ft)	Boom Length (ft)			
	Fly Offset			
	200.1			
	2°	15°	30°	45°
40	16,100			
45	16,100			
50	16,100	16,100		
55	16,100	16,100		
60	16,100	16,100	15,900	
65	16,100	16,100	15,900	15,600
70	16,100	16,100	15,900	15,600
75	16,100	16,100	15,900	15,600
80	16,100	16,100	15,900	15,600
85	16,100	16,100	15,900	15,600
90	16,100	16,100	15,900	15,600
95	16,100	16,100	15,900	15,600
100	16,000	16,100	15,900	15,600
105	14,400	15,300	15,900	15,600
110	12,900	13,700	14,600	15,300
115	11,500	12,300	13,100	13,700
120	10,300	11,100	11,800	12,400
125	9,200	9,900	10,600	11,100
130	8,200	8,900	9,500	10,000
135	7,300	7,900	8,500	8,900
140	6,400	7,000	7,600	8,000
145	5,600	6,200	6,700	7,100
150	4,900	5,400	5,900	6,200
155	4,200	4,700	5,200	5,400
160	3,600	4,100	4,500	4,700
165	3,000	3,400	3,800	4,000
170	2,500	2,900	3,200	3,400
175		2,300	2,600	2,800
180			2,100	2,200
Min Angle	45.5	46.0	46.0	46.0
Max Rad.	175.0	178.0	181.0	182.0
Capacity	0	0	0	0

1041040



PORTLAND OFFICE: 503.283.3111
 SEATTLE OFFICE: 206.784.1054
WWW.NESSCAMPBELL.COM

Rated Lifting Capacities in Pounds

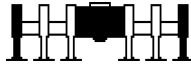

Full

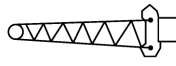

40ft Offset Fly



58,000 lbs



Radius (ft)	Boom Length (ft)											
	Fly Offset											
	44.3				58.9				89.1			
	2°	15°	30°	45°	2°	15°	30°	45°	2°	15°	30°	45°
10	34,700				34,700							
12	34,700				34,700							
15	34,700	34,700			34,700				34,600			
20	34,700	32,000			34,700	34,200			34,600			
25	33,900	28,800	24,900		34,700	31,100	25,900		34,600	34,600		
30	30,200	26,200	22,900	20,200	34,200	28,400	24,100		34,600	32,100	25,900	
35	27,200	24,000	20,700	19,000	31,000	26,200	21,900	19,800	34,600	29,900	24,500	
40	24,800	21,400	19,400	18,000	28,300	24,300	20,700	18,800	34,600	28,000	23,300	20,000
45	21,900	19,900	18,200	17,200	26,000	22,000	19,600	18,000	32,200	26,300	21,700	19,300
50	20,200	18,600	17,300	16,400	24,000	20,600	18,600	17,300	29,900	24,900	20,700	18,600
55	18,800	17,500	16,400	15,800	21,600	19,500	17,800	16,700	27,900	23,600	19,900	18,000
60	17,500	16,500	15,700	15,300	20,200	18,400	17,000	16,100	26,200	21,800	19,100	17,500
65	16,400	15,600	15,000	14,900	19,000	17,500	16,300	15,700	24,600	20,800	18,400	17,000
70	15,400	14,900	14,600		17,900	16,700	15,700	15,300	23,300	19,900	17,800	16,600
75	14,500	14,300			16,900	15,900	15,200	15,000	21,400	19,000	17,200	16,200
80					16,000	15,300	14,800		20,400	18,300	16,700	15,800
85					15,200	14,700	14,500		19,400	17,600	16,200	15,500
90					14,500				18,500	16,900	15,800	15,300
95									17,700	16,400	15,400	15,100
100									17,000	15,800	15,100	14,900
105									16,300	15,300	14,800	
110									15,700	14,900	14,600	
115									15,100	14,600		
120									14,500			
Min Angle	0.0	0.0	0.0	0.0	0.0	0.0	0.0	0.0	0.0	0.0	0.0	0.0
Max Rad. Capacity	75.9	75.8	74.5	71.9	90.5	90.4	88.8	85.9	120.7	120.5	118.6	115.2
	11,200	11,400	12,100	13,600	6,600	6,700	7,000	7,700	4,900	5,000	5,200	5,700

1041050



PORTLAND OFFICE: 503.283.3111
 SEATTLE OFFICE: 206.784.1054
WWW.NESSCAMPBELL.COM

Rated Lifting Capacities in Pounds

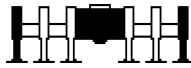

Full

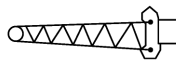

40ft Offset Fly



58,000 lbs



Boom Length (ft)												
Fly Offset												
Radius (ft)	120.3				152.4				169.0			
	2°	15°	30°	45°	2°	15°	30°	45°	2°	15°	30°	45°
25	34,500											
30	34,500				31,300							
35	34,500	32,800			31,300							
40	34,500	30,900			31,300				29,200			
45	34,500	29,300	23,700		31,300	31,200			29,200			
50	34,500	27,800	22,800	19,500	31,300	30,300	24,000		29,200	29,100		
55	33,100	26,500	21,500	19,000	31,300	28,900	23,200		29,200	29,100	23,800	
60	31,200	25,300	20,800	18,500	31,300	27,700	22,000	19,300	29,200	28,800	23,100	
65	29,300	24,200	20,100	18,000	29,700	26,600	21,400	18,800	29,200	27,700	22,000	19,200
70	27,300	23,200	19,500	17,600	27,600	25,600	20,800	18,400	29,200	26,700	21,400	18,800
75	25,500	21,700	18,900	17,200	25,700	24,600	20,200	18,100	27,500	25,700	20,800	18,400
80	23,800	20,900	18,300	16,900	24,000	23,700	19,700	17,700	25,300	24,800	20,300	18,100
85	22,500	20,200	17,900	16,500	22,500	22,500	19,200	17,400	22,600	23,700	19,800	17,800
90	21,100	19,500	17,400	16,200	21,100	21,200	18,800	17,100	20,200	21,300	19,400	17,400
95	19,900	18,800	17,000	16,000	19,300	19,900	18,300	16,800	18,100	19,100	18,900	17,200
100	18,800	18,200	16,600	15,700	17,400	18,200	17,900	16,500	16,500	17,100	18,100	16,900
105	17,400	17,700	16,200	15,500	16,000	16,800	17,300	16,300	14,900	15,700	16,600	16,600
110	16,100	16,600	15,800	15,300	14,500	15,200	15,900	16,000	13,400	14,200	14,900	15,500
115	14,700	15,200	15,600	15,100	13,200	13,800	14,400	14,900	12,000	12,800	13,500	14,000
120	13,500	13,900	14,300	14,500	11,900	12,500	13,100	13,500	10,800	11,500	12,200	12,600
125	12,400	12,800	13,100	13,200	10,800	11,400	11,900	12,200	9,700	10,300	11,000	11,400
130	11,400	11,700	11,900		9,800	10,300	10,800	11,100	8,700	9,300	9,800	10,200
135	10,400	10,700	10,900		8,900	9,400	9,800	10,000	7,800	8,300	8,800	9,100
140	9,600	9,800	9,900		8,000	8,500	8,800	9,000	6,900	7,400	7,900	8,200
145	8,800	9,000			7,200	7,600	8,000	8,100	6,100	6,600	7,000	7,300
150	8,100	8,200			6,500	6,900	7,100	7,200	5,400	5,800	6,200	6,400
155					5,800	6,200	6,400		4,700	5,100	5,500	5,600
160					5,200	5,500	5,700		4,100	4,500	4,800	4,900
165					4,600	4,900	5,000		3,500	3,900	4,100	
170					4,100	4,300	4,400		3,000	3,300	3,500	
175					3,600	3,700			2,500	2,700	2,900	
180									2,200	2,300		
Min Angle	0.0	0.0	0.0	0.0	16.0	17.5	16.0	20.5	30.0	30.5	30.5	30.0
Max Rad.	151.9	151.6	149.6	145.9	180.0	180.0	180.0	175.0	180.0	182.0	183.0	182.5
Capacity	3,200	3,200	3,400	3,700	0	0	0	0	0	0	0	0

1041050



PORTLAND OFFICE: 503.283.3111
 SEATTLE OFFICE: 206.784.1054
WWW.NESSCAMPBELL.COM

Rated Lifting Capacities in Pounds

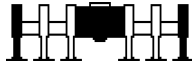

Full

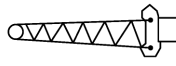

40ft Offset Fly



58,000 lbs



Radius (ft)	Boom Length (ft)			
	Fly Offset			
	185.5			
	2°	15°	30°	45°
40	20,200			
45	20,200			
50	20,200	20,100		
55	20,200	20,100		
60	20,200	20,100	19,900	
65	20,200	20,100	19,900	
70	20,200	20,100	19,900	19,100
75	20,200	20,100	19,900	18,700
80	20,200	20,100	19,900	18,400
85	20,200	20,100	19,900	18,100
90	19,100	20,100	19,900	17,800
95	17,000	18,100	19,200	17,500
100	15,500	16,500	17,200	17,200
105	13,900	14,800	15,700	16,400
110	12,400	13,300	14,100	14,800
115	11,100	11,900	12,700	13,300
120	9,800	10,600	11,300	11,900
125	8,700	9,500	10,100	10,600
130	7,700	8,400	9,000	9,500
135	6,800	7,400	8,000	8,400
140	6,000	6,600	7,100	7,400
145	5,200	5,700	6,200	6,500
150	4,500	5,000	5,400	5,700
155	3,800	4,300	4,700	4,900
160	3,200	3,600	4,000	4,200
165	2,600	3,000	3,300	3,500
170		2,400	2,700	2,800
175			2,100	2,200
Min Angle	42.5	42.5	43.0	43.0
Max Rad.	170.0	174.0	176.0	176.7
Capacity	0	0	0	0

1041050



PORTLAND OFFICE: 503.283.3111
 SEATTLE OFFICE: 206.784.1054
WWW.NESSCAMPBELL.COM

Rated Lifting Capacities in Pounds

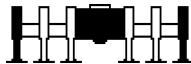

Full

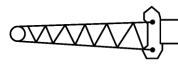

40ft Offset Fly



58,000 lbs



Radius (ft)	Boom Length (ft)											
	Fly Offset											
	44.3				73.5				103.8			
	2°	15°	30°	45°	2°	15°	30°	45°	2°	15°	30°	45°
10	34,700											
12	34,700				34,600							
15	34,700	34,700			34,600							
20	34,700	32,000			34,600	34,600			34,500			
25	33,900	28,800	24,900		34,600	32,900			34,500			
30	30,200	26,200	22,900	20,200	34,600	30,300	25,100		34,500	33,500		
35	27,200	24,000	20,700	19,000	34,500	28,100	23,600	20,300	34,500	31,400	25,200	
40	24,800	21,400	19,400	18,000	31,600	26,200	21,700	19,500	34,500	29,500	24,000	20,400
45	21,900	19,900	18,200	17,200	29,100	24,600	20,700	18,700	34,500	27,800	23,000	19,700
50	20,200	18,600	17,300	16,400	27,000	23,100	19,700	18,000	32,500	26,300	21,500	19,100
55	18,800	17,500	16,400	15,800	25,100	21,200	18,900	17,400	30,400	25,000	20,700	18,500
60	17,500	16,500	15,700	15,300	23,500	20,100	18,100	16,900	28,600	23,800	20,000	18,000
65	16,400	15,600	15,000	14,900	21,400	19,200	17,400	16,400	26,700	22,700	19,300	17,500
70	15,400	14,900	14,600		20,200	18,300	16,800	15,900	24,800	21,200	18,600	17,100
75	14,500	14,300			19,200	17,500	16,200	15,600	23,200	20,400	18,000	16,700
80					18,200	16,800	15,700	15,300	22,000	19,600	17,500	16,400
85					17,300	16,100	15,300	15,000	20,600	18,800	17,000	16,000
90					16,500	15,500	14,900		19,400	18,200	16,600	15,700
95					15,700	15,000	14,600		18,100	17,600	16,200	15,500
100					15,100	14,600			17,000	17,000	15,800	15,300
105					9,500				16,000	16,000	15,400	15,100
110									15,100	15,100	15,100	14,900
115									14,300	14,300	14,300	
120									13,500	13,500	13,500	
125									12,800	12,800	12,800	
130									12,200	12,200		
135									8,800			
Min Angle	0.0	0.0	0.0	0.0	0.0	0.0	0.0	0.0	0.0	0.0	0.0	0.0
Max Rad.	75.9	75.8	74.5	71.9	105.1	104.9	103.2	100.0	135.3	135.1	133.1	129.6
Capacity	11,200	11,400	12,100	13,600	3,700	3,700	3,900	4,200	2,600	2,600	2,700	2,900

1041060



PORTLAND OFFICE: 503.283.3111
 SEATTLE OFFICE: 206.784.1054
WWW.NESSCAMPBELL.COM

Rated Lifting Capacities in Pounds

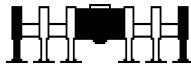

Full

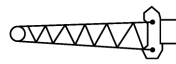

40ft Offset Fly



58,000 lbs



Radius (ft)	Boom Length (ft)											
	Fly Offset											
	119.4				135.4				152.0			
	2°	15°	30°	45°	2°	15°	30°	45°	2°	15°	30°	45°
25	33,900				34,400							
30	33,900				34,400				33,800			
35	33,900	32,700			34,400	33,900			33,800			
40	33,900	30,900	24,700		34,400	32,100			33,800	33,300		
45	33,900	29,200	23,700	20,100	34,400	30,500	24,300		33,800	31,700	24,900	
50	33,900	27,700	22,800	19,500	34,400	29,000	23,400	19,900	33,800	30,200	24,000	20,200
55	33,000	26,400	21,500	19,000	34,400	27,700	22,100	19,400	33,800	28,900	23,200	19,700
60	31,000	25,200	20,700	18,500	33,400	26,500	21,400	18,900	33,800	27,700	22,000	19,200
65	28,900	24,100	20,000	18,000	31,200	25,400	20,700	18,400	33,100	26,600	21,400	18,800
70	27,000	23,100	19,400	17,600	29,200	24,300	20,100	18,000	31,100	25,500	20,800	18,400
75	25,300	21,600	18,800	17,200	27,400	23,400	19,600	17,600	29,300	24,600	20,200	18,000
80	23,800	20,800	18,300	16,900	25,800	22,000	19,000	17,300	26,600	23,700	19,700	17,700
85	22,500	20,100	17,800	16,500	24,400	21,300	18,500	17,000	23,900	22,900	19,200	17,400
90	21,300	19,400	17,300	16,200	22,900	20,600	18,100	16,700	21,500	21,700	18,700	17,100
95	20,100	18,800	16,900	15,900	20,800	19,900	17,600	16,400	19,300	20,200	18,300	16,800
100	19,100	18,200	16,500	15,700	18,900	19,300	17,200	16,100	17,500	18,300	17,900	16,500
105	18,000	17,600	16,100	15,500	17,200	17,900	16,800	15,900	16,100	16,800	17,300	16,300
110	16,900	16,800	15,800	15,300	16,000	16,500	16,500	15,600	14,600	15,300	16,000	16,000
115	15,500	16,000	15,500	15,100	14,600	15,100	15,600	15,500	13,200	13,900	14,500	14,900
120	14,300	14,700	15,000	15,000	13,400	13,900	14,300	14,600	12,000	12,600	13,200	13,500
125	13,200	13,500	13,800	13,900	12,300	12,700	13,100	13,300	10,900	11,500	12,000	12,300
130	12,200	12,500	12,700		11,200	11,600	12,000	12,100	9,900	10,400	10,800	11,100
135	11,200	11,500	11,600		10,300	10,700	11,000	11,100	9,000	9,400	9,800	10,000
140	10,400	10,600	10,700		9,400	9,800	10,000		8,100	8,500	8,900	9,100
145	9,600	9,700			8,700	8,900	9,100		7,300	7,700	8,000	8,100
150					7,900	8,200	8,300		6,600	6,900	7,200	
155					7,300	7,400	7,500		5,900	6,200	6,400	
160					6,600	6,800			5,300	5,500	5,700	
165									4,700	4,900	5,100	
170									4,200	4,300	4,400	
175									3,700	3,800		
Min Angle	11.0	12.0	0.0	0.0	13.0	14.5	22.5	4.0	14.5	16.0	14.0	19.5
Max Rad.	150.0	150.0	148.6	144.9	165.0	165.0	160.0	158.9	180.0	180.0	180.0	175.0
Capacity	0	0	2,000	2,200	0	0	0	0	0	0	0	0

1041060



PORTLAND OFFICE: 503.283.3111
 SEATTLE OFFICE: 206.784.1054
WWW.NESSCAMPBELL.COM

Rated Lifting Capacities in Pounds

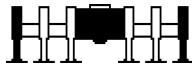

Full

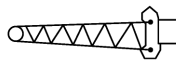

40ft Offset Fly



58,000 lbs



Radius (ft)	Boom Length (ft)			
	Fly Offset			
	168.5			
	2°	15°	30°	45°
35	29,200			
40	29,200			
45	29,200	29,000		
50	29,200	29,000		
55	29,200	29,000	23,800	
60	29,200	28,800	23,100	19,600
65	29,200	27,700	22,000	19,200
70	29,200	26,600	21,400	18,800
75	28,600	25,700	20,800	18,400
80	25,400	24,800	20,300	18,100
85	22,600	23,800	19,800	17,700
90	20,200	21,300	19,300	17,400
95	18,100	19,100	18,900	17,100
100	16,600	17,200	18,100	16,900
105	14,900	15,800	16,600	16,600
110	13,400	14,200	15,000	15,600
115	12,100	12,800	13,500	14,000
120	10,900	11,600	12,200	12,700
125	9,800	10,400	11,000	11,400
130	8,800	9,300	9,900	10,300
135	7,800	8,400	8,900	9,200
140	7,000	7,500	7,900	8,200
145	6,200	6,700	7,100	7,300
150	5,500	5,900	6,300	6,500
155	4,800	5,200	5,500	5,700
160	4,200	4,500	4,800	4,900
165	3,600	3,900	4,200	
170	3,000	3,300	3,500	
175	2,500	2,800	3,000	
180		2,300	2,400	
Min Angle	29.0	29.0	29.0	29.0
Max Rad.	180.0	183.0	184.0	183.0
Capacity	0	0	0	0

1041060



PORTLAND OFFICE: 503.283.3111
 SEATTLE OFFICE: 206.784.1054
WWW.NESSCAMPBELL.COM

Rated Lifting Capacities in Pounds

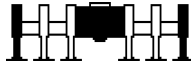

Full

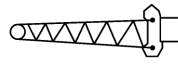

40ft Hydraulic Offset Fly



58,000 lbs



Radius (ft)	Boom Length (ft)											
	Fly Offset											
	44.3			73.5			103.8			134.9		
	2°-15°	15°-30°	30°-45°	2°-15°	15°-30°	30°-45°	2°-15°	15°-30°	30°-45°	2°-15°	15°-30°	30°-45°
10	34,700											
12	34,700	34,700		34,600								
15	34,700	34,700		34,600								
20	32,000	27,100	27,100	34,600	34,600		34,500					
25	28,800	24,900	24,900	32,900	32,900		34,500	34,500		29,700		
30	26,200	22,900	20,200	30,300	25,100	25,100	33,500	33,500		29,700		
35	24,000	20,700	19,000	28,100	23,600	20,300	31,400	25,200	25,200	29,500	29,500	
40	21,400	19,400	18,000	26,200	21,700	19,500	29,500	24,000	20,400	29,500	25,300	25,300
45	19,900	18,200	17,200	24,600	20,700	18,700	27,800	23,000	19,700	29,500	24,300	20,400
50	18,600	17,300	16,400	23,100	19,700	18,000	26,300	21,500	19,100	29,000	23,400	19,900
55	17,500	16,400	15,800	21,200	18,900	17,400	25,000	20,700	18,500	27,700	22,100	19,300
60	16,500	15,700	15,300	20,100	18,100	16,900	23,800	20,000	18,000	26,400	21,400	18,900
65	15,600	15,000	14,900	19,200	17,400	16,400	22,700	19,300	17,500	25,300	20,700	18,400
70	14,900	14,600	14,600	18,300	16,800	15,900	21,200	18,600	17,100	24,300	20,100	18,000
75	14,300	14,300		17,500	16,200	15,600	20,400	18,000	16,700	23,400	19,600	17,600
80				16,800	15,700	15,300	19,600	17,500	16,400	22,000	19,000	17,300
85				16,100	15,300	15,000	18,800	17,000	16,000	21,200	18,500	17,000
90				15,500	14,900	14,900	18,200	16,600	15,700	19,900	18,000	16,600
95				15,000	14,600	14,600	17,600	16,200	15,500	18,800	17,600	16,400
100				14,600	14,500		17,000	15,800	15,300	17,700	17,200	16,100
105				9,500			16,000	15,400	15,100	16,700	16,700	15,800
110							15,100	15,100	14,900	15,800	15,800	15,600
115							14,300	14,300	14,300	15,000	15,000	15,000
120							13,500	13,500	13,500	13,900	14,200	14,200
125							12,800	12,800	12,800	12,700	13,200	13,500
130							12,200	12,200		11,700	12,100	12,400
135							8,800			10,800	11,100	11,400
140										9,900	10,200	10,500
145										9,100	9,400	9,600
150										8,400	8,600	8,700
155										7,700	7,900	7,900
160										7,100		
Min Angle	0.0	0.0	0.0	0.0	0.0	0.0	0.0	0.0	0.0	12.5	22.5	4.0
Max Rad.	75.9	75.8	74.5	105.1	104.9	103.2	135.3	135.1	133.1	165.0	160.0	158.4
Capacity	11,200	11,400	12,100	3,700	3,700	3,900	2,600	2,600	2,700	0	0	0

1042040



PORTLAND OFFICE: 503.283.3111
 SEATTLE OFFICE: 206.784.1054
WWW.NESSCAMPBELL.COM

Rated Lifting Capacities in Pounds

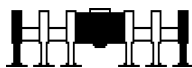

Full

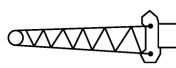

40ft Hydraulic Offset Fly



58,000 lbs



Radius (ft)	Boom Length (ft)								
	Fly Offset								
	167.1			183.6			200.1		
	2°-15°	15°-30°	30°-45°	2°-15°	15°-30°	30°-45°	2°-15°	15°-30°	30°-45°
30	19,800								
35	19,800			18,600					
40	19,700	19,700		18,400	18,400		16,100		
45	19,700	19,500	19,500	18,400	18,400		16,000	16,000	
50	19,700	19,500	19,500	18,400	18,400		16,000	16,000	
55	19,700	19,500	19,200	18,400	18,300	18,300	16,000	15,800	15,800
60	19,700	19,500	19,200	18,400	18,300	18,000	16,000	15,800	15,600
65	19,700	19,500	19,100	18,400	18,300	18,000	16,000	15,800	15,600
70	19,700	19,500	18,700	18,400	18,300	18,000	16,000	15,800	15,600
75	19,700	19,500	18,400	18,400	18,300	18,000	16,000	15,800	15,600
80	19,700	19,500	18,000	18,400	18,300	18,000	16,000	15,800	15,600
85	19,700	19,500	17,700	18,400	18,300	18,000	16,000	15,800	15,600
90	19,700	19,300	17,400	18,400	18,300	17,700	16,000	15,800	15,600
95	19,300	18,900	17,100	18,400	18,300	17,500	16,000	15,800	15,600
100	17,800	18,300	16,900	17,000	17,600	17,200	16,000	15,800	15,600
105	16,400	16,900	16,600	15,300	16,200	16,900	14,400	15,300	15,600
110	14,900	15,600	16,300	13,800	14,600	15,400	12,900	13,700	14,600
115	13,600	14,200	14,900	12,500	13,200	13,900	11,500	12,300	13,100
120	12,400	13,000	13,600	11,300	12,000	12,600	10,300	11,100	11,800
125	11,200	11,800	12,300	10,200	10,800	11,400	9,200	9,900	10,600
130	10,200	10,800	11,200	9,100	9,700	10,300	8,200	8,900	9,500
135	9,300	9,800	10,200	8,200	8,800	9,300	7,300	7,900	8,500
140	8,400	8,900	9,300	7,400	7,900	8,400	6,400	7,000	7,600
145	7,600	8,100	8,400	6,600	7,100	7,500	5,600	6,200	6,700
150	6,900	7,300	7,600	5,800	6,300	6,700	4,900	5,400	5,900
155	6,200	6,600	6,900	5,200	5,600	6,000	4,200	4,700	5,200
160	5,600	5,900	6,200	4,500	4,900	5,300	3,600	4,100	4,500
165	5,000	5,300	5,500	3,900	4,300	4,600	3,000	3,400	3,800
170	4,500	4,700	4,900	3,400	3,700	4,000	2,500	2,900	3,200
175	3,900	4,200	4,300	2,900	3,200	3,400		2,300	2,600
180	3,500	3,700	3,700	2,400	2,700	2,900			2,100
185	3,000	3,200	3,100		2,200	2,400			
190	2,600	2,700							
Min Angle	15.5	14.5	19.0	35.5	35.5	35.5	45.5	46.0	46.0
Max Rad.	195.0	195.0	190.0	184.0	187.0	188.3	175.0	178.0	181.0
Capacity	0	0	0	0	0	0	0	0	0

1042040



PORTLAND OFFICE: 503.283.3111
 SEATTLE OFFICE: 206.784.1054
WWW.NESSCAMPBELL.COM

Rated Lifting Capacities in Pounds

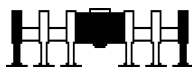

Full

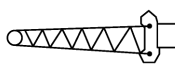

40ft Hydraulic Offset Fly



58,000 lbs



Radius (ft)	Boom Length (ft)											
	Fly Offset											
	44.3			58.9			89.1			120.3		
	2°-15°	15°-30°	30°-45°	2°-15°	15°-30°	30°-45°	2°-15°	15°-30°	30°-45°	2°-15°	15°-30°	30°-45°
10	34,700			34,700								
12	34,700	34,700		34,700								
15	34,700	34,700		34,700	34,700		34,600					
20	32,000	27,100	27,100	34,200	34,200		34,600	34,600				
25	28,800	24,900	24,900	31,100	25,900	25,900	34,600	34,600		34,500		
30	26,200	22,900	20,200	28,400	24,100	20,800	32,100	25,900	25,900	34,500	34,500	
35	24,000	20,700	19,000	26,200	21,900	19,800	29,900	24,500	20,800	32,800	25,800	25,800
40	21,400	19,400	18,000	24,300	20,700	18,800	28,000	23,300	20,000	30,900	24,700	24,700
45	19,900	18,200	17,200	22,000	19,600	18,000	26,300	21,700	19,300	29,300	23,700	20,100
50	18,600	17,300	16,400	20,600	18,600	17,300	24,900	20,700	18,600	27,800	22,800	19,500
55	17,500	16,400	15,800	19,500	17,800	16,700	23,600	19,900	18,000	26,500	21,500	19,000
60	16,500	15,700	15,300	18,400	17,000	16,100	21,800	19,100	17,500	25,300	20,800	18,500
65	15,600	15,000	14,900	17,500	16,300	15,700	20,800	18,400	17,000	24,200	20,100	18,000
70	14,900	14,600	14,600	16,700	15,700	15,300	19,900	17,800	16,600	23,200	19,500	17,600
75	14,300	14,300		15,900	15,200	15,000	19,000	17,200	16,200	21,700	18,900	17,200
80				15,300	14,800	14,800	18,300	16,700	15,800	20,900	18,300	16,900
85				14,700	14,500	14,500	17,600	16,200	15,500	20,200	17,900	16,500
90				14,300			16,900	15,800	15,300	19,500	17,400	16,200
95							16,400	15,400	15,100	18,800	17,000	16,000
100							15,800	15,100	14,900	18,200	16,600	15,700
105							15,300	14,800	14,800	17,400	16,200	15,500
110							14,900	14,600	14,600	16,100	15,800	15,300
115							14,600	14,500		14,700	15,200	15,100
120							14,400			13,500	13,900	14,300
125										12,400	12,800	13,100
130										11,400	11,700	11,900
135										10,400	10,700	10,900
140										9,600	9,800	9,800
145										8,800	9,000	
150										8,100	8,200	
Min Angle	0.0	0.0	0.0	0.0	0.0	0.0	0.0	0.0	0.0	0.0	0.0	0.0
Max Rad.	75.9	75.8	74.5	90.5	90.4	88.8	120.7	120.5	118.6	151.9	151.6	149.6
Capacity	11,200	11,400	12,100	6,600	6,700	7,000	4,900	5,000	5,200	3,200	3,200	3,400

1042050



PORTLAND OFFICE: 503.283.3111
 SEATTLE OFFICE: 206.784.1054
WWW.NESSCAMPBELL.COM

Rated Lifting Capacities in Pounds

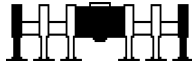

Full

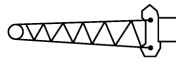

40ft Hydraulic Offset Fly



58,000 lbs



Boom Length (ft)									
Fly Offset									
Radius (ft)	152.4			169.0			185.5		
	2°-15°	15°-30°	30°-45°	2°-15°	15°-30°	30°-45°	2°-15°	15°-30°	30°-45°
30	31,300								
35	31,000	31,000							
40	31,000	31,000		29,200			20,200		
45	31,000	24,900	24,900	29,000	29,000		20,100	20,100	
50	30,300	24,000	20,200	29,000	24,500	24,500	20,100	20,100	
55	28,900	23,200	19,700	29,000	23,800	23,800	20,100	19,800	19,800
60	27,700	22,000	19,300	28,800	23,100	19,600	20,100	19,800	19,800
65	26,600	21,400	18,800	27,700	22,000	19,200	20,100	19,800	19,500
70	25,600	20,800	18,400	26,700	21,400	18,800	20,100	19,800	19,100
75	24,600	20,200	18,100	25,700	20,800	18,400	20,100	19,800	18,700
80	23,700	19,700	17,700	24,800	20,300	18,100	20,100	19,800	18,400
85	22,500	19,200	17,400	22,600	19,800	17,800	20,100	19,800	18,100
90	21,100	18,800	17,100	20,200	19,400	17,400	19,100	19,800	17,800
95	19,300	18,300	16,800	18,100	18,900	17,200	17,000	18,100	17,500
100	17,400	17,900	16,500	16,500	17,100	16,900	15,500	16,500	17,200
105	16,000	16,800	16,300	14,900	15,700	16,600	13,900	14,800	15,700
110	14,500	15,200	15,900	13,400	14,200	14,900	12,400	13,300	14,100
115	13,200	13,800	14,400	12,000	12,800	13,500	11,100	11,900	12,700
120	11,900	12,500	13,100	10,800	11,500	12,200	9,800	10,600	11,300
125	10,800	11,400	11,900	9,700	10,300	11,000	8,700	9,500	10,100
130	9,800	10,300	10,800	8,700	9,300	9,800	7,700	8,400	9,000
135	8,900	9,400	9,800	7,800	8,300	8,800	6,800	7,400	8,000
140	8,000	8,500	8,800	6,900	7,400	7,900	6,000	6,600	7,100
145	7,200	7,600	8,000	6,100	6,600	7,000	5,200	5,700	6,200
150	6,500	6,900	7,100	5,400	5,800	6,200	4,500	5,000	5,400
155	5,800	6,200	6,400	4,700	5,100	5,500	3,800	4,300	4,700
160	5,200	5,500	5,700	4,100	4,500	4,800	3,200	3,600	4,000
165	4,600	4,900	5,000	3,500	3,900	4,100	2,600	3,000	3,300
170	4,100	4,300	4,300	3,000	3,300	3,500		2,400	2,700
175	3,600	3,700		2,500	2,700	2,900			2,100
180					2,200	2,300			
Min Angle	16.0	16.0	20.5	30.0	30.5	30.0	42.5	42.5	43.0
Max Rad.	180.0	180.0	175.0	180.0	182.0	182.5	170.0	174.0	176.0
Capacity	0	0	0	0	0	0	0	0	0

1042050



PORTLAND OFFICE: 503.283.3111
 SEATTLE OFFICE: 206.784.1054
WWW.NESSCAMPBELL.COM

Rated Lifting Capacities in Pounds

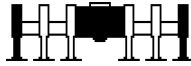

Full

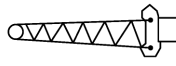

40ft Hydraulic Offset Fly



58,000 lbs



Boom Length (ft)												
Fly Offset												
Radius (ft)	44.3			73.5			103.8			119.4		
	2°-15°	15°-30°	30°-45°	2°-15°	15°-30°	30°-45°	2°-15°	15°-30°	30°-45°	2°-15°	15°-30°	30°-45°
10	34,700											
12	34,700	34,700		34,600								
15	34,700	34,700		34,600								
20	32,000	27,100	27,100	34,600	34,600		34,500					
25	28,800	24,900	24,900	32,900	32,900		34,500	34,500		33,900		
30	26,200	22,900	20,200	30,300	25,100	25,100	33,500	33,500		33,600	33,600	
35	24,000	20,700	19,000	28,100	23,600	20,300	31,400	25,200	25,200	32,700	25,800	25,800
40	21,400	19,400	18,000	26,200	21,700	19,500	29,500	24,000	20,400	30,900	24,700	20,700
45	19,900	18,200	17,200	24,600	20,700	18,700	27,800	23,000	19,700	29,200	23,700	20,100
50	18,600	17,300	16,400	23,100	19,700	18,000	26,300	21,500	19,100	27,700	22,800	19,500
55	17,500	16,400	15,800	21,200	18,900	17,400	25,000	20,700	18,500	26,400	21,500	19,000
60	16,500	15,700	15,300	20,100	18,100	16,900	23,800	20,000	18,000	25,200	20,700	18,500
65	15,600	15,000	14,900	19,200	17,400	16,400	22,700	19,300	17,500	24,100	20,000	18,000
70	14,900	14,600	14,600	18,300	16,800	15,900	21,200	18,600	17,100	23,100	19,400	17,600
75	14,300	14,300		17,500	16,200	15,600	20,400	18,000	16,700	21,600	18,800	17,200
80				16,800	15,700	15,300	19,600	17,500	16,400	20,800	18,300	16,900
85				16,100	15,300	15,000	18,800	17,000	16,000	20,100	17,800	16,500
90				15,500	14,900	14,900	18,200	16,600	15,700	19,400	17,300	16,200
95				15,000	14,600	14,600	17,600	16,200	15,500	18,800	16,900	15,900
100				14,600	14,500		17,000	15,800	15,300	18,200	16,500	15,700
105				9,500			16,000	15,400	15,100	17,600	16,100	15,500
110							15,100	15,100	14,900	16,800	15,800	15,300
115							14,300	14,300	14,300	15,500	15,500	15,100
120							13,500	13,500	13,500	14,300	14,700	15,000
125							12,800	12,800	12,800	13,200	13,500	13,800
130							12,200	12,200		12,200	12,500	12,700
135							8,800			11,200	11,500	11,600
140										10,400	10,600	10,500
145										9,600	9,700	
Min Angle	0.0	0.0	0.0	0.0	0.0	0.0	0.0	0.0	0.0	11.0	12.0	0.0
Max Rad.	75.9	75.8	74.5	105.1	104.9	103.2	135.3	135.1	133.1	150.0	150.0	148.6
Capacity	11,200	11,400	12,100	3,700	3,700	3,900	2,600	2,600	2,700	0	0	2,000

1042060



PORTLAND OFFICE: 503.283.3111
 SEATTLE OFFICE: 206.784.1054
WWW.NESSCAMPBELL.COM

Rated Lifting Capacities in Pounds

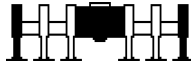

Full

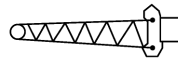

40ft Hydraulic Offset Fly



58,000 lbs



Radius (ft)	Boom Length (ft)								
	Fly Offset								
	135.4			152.0			168.5		
	2°-15°	15°-30°	30°-45°	2°-15°	15°-30°	30°-45°	2°-15°	15°-30°	30°-45°
25	34,400								
30	34,400			33,800					
35	33,900	33,900		33,500	33,500		29,200		
40	32,100	25,300	25,300	33,300	33,300		28,900	28,900	
45	30,500	24,300	20,400	31,700	24,900	24,900	28,900	28,900	
50	29,000	23,400	19,900	30,200	24,000	20,200	28,900	24,500	24,500
55	27,700	22,100	19,400	28,900	23,200	19,700	28,900	23,800	20,000
60	26,500	21,400	18,900	27,700	22,000	19,200	28,800	23,100	19,600
65	25,400	20,700	18,400	26,600	21,400	18,800	27,700	22,000	19,200
70	24,300	20,100	18,000	25,500	20,800	18,400	26,600	21,400	18,800
75	23,400	19,600	17,600	24,600	20,200	18,000	25,700	20,800	18,400
80	22,000	19,000	17,300	23,700	19,700	17,700	24,800	20,300	18,100
85	21,300	18,500	17,000	22,900	19,200	17,400	22,600	19,800	17,700
90	20,600	18,100	16,700	21,500	18,700	17,100	20,200	19,300	17,400
95	19,900	17,600	16,400	19,300	18,300	16,800	18,100	18,900	17,100
100	18,900	17,200	16,100	17,500	17,900	16,500	16,600	17,200	16,900
105	17,200	16,800	15,900	16,100	16,800	16,300	14,900	15,800	16,600
110	16,000	16,500	15,600	14,600	15,300	16,000	13,400	14,200	15,000
115	14,600	15,100	15,500	13,200	13,900	14,500	12,100	12,800	13,500
120	13,400	13,900	14,300	12,000	12,600	13,200	10,900	11,600	12,200
125	12,300	12,700	13,100	10,900	11,500	12,000	9,800	10,400	11,000
130	11,200	11,600	12,000	9,900	10,400	10,800	8,800	9,300	9,900
135	10,300	10,700	11,000	9,000	9,400	9,800	7,800	8,400	8,900
140	9,400	9,800	10,000	8,100	8,500	8,900	7,000	7,500	7,900
145	8,700	8,900	9,100	7,300	7,700	8,000	6,200	6,700	7,100
150	7,900	8,200	8,200	6,600	6,900	7,200	5,500	5,900	6,300
155	7,300	7,400	7,400	5,900	6,200	6,400	4,800	5,200	5,500
160	6,600			5,300	5,500	5,700	4,200	4,500	4,800
165				4,700	4,900	5,000	3,600	3,900	4,200
170				4,200	4,300	4,300	3,000	3,300	3,500
175				3,700	3,800		2,500	2,800	2,900
180								2,300	2,300
Min Angle	13.0	22.5	4.0	14.5	14.0	19.5	29.0	29.0	29.0
Max Rad.	165.0	160.0	158.9	180.0	180.0	175.0	180.0	183.0	183.0
Capacity	0	0	0	0	0	0	0	0	0

1042060



PORTLAND OFFICE: 503.283.3111
 SEATTLE OFFICE: 206.784.1054
WWW.NESSCAMPBELL.COM

Rated Lifting Capacities in Pounds

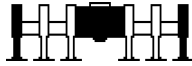

Full

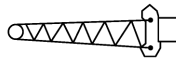

67ft Offset Fly



58,000 lbs



Radius (ft)	Boom Length (ft)											
	Fly Offset											
	44.3				73.5				103.8			
	2°	15°	30°	45°	2°	15°	30°	45°	2°	15°	30°	45°
15	30,000											
20	27,800				27,500							
25	24,600	19,800			27,500				18,200			
30	21,100	18,100			21,400				18,200			
35	19,100	16,600			21,400	18,500			18,200			
40	17,400	15,400	13,700		21,100	17,300			18,200	18,100		
45	16,000	14,300	12,800		19,500	16,200	13,700		18,200	17,700		
50	14,800	13,300	12,100		18,100	15,300	13,100		18,200	16,800		
55	13,800	12,500	11,400	10,600	16,900	14,400	12,400		18,200	15,900	13,200	
60	12,800	11,700	10,800	10,100	15,800	13,600	11,900	10,700	18,200	15,200	12,700	
65	12,000	11,100	10,300	9,700	14,900	12,900	11,400	10,300	17,500	14,500	12,200	10,800
70	11,200	10,500	9,800	9,300	14,000	12,300	10,900	10,000	16,600	13,800	11,800	10,500
75	10,600	9,900	9,300	8,900	13,200	11,700	10,500	9,700	15,700	13,200	11,400	10,200
80	10,000	9,400	8,900	8,600	12,500	11,200	10,100	9,400	14,900	12,700	11,000	9,900
85	9,400	9,000	8,600	8,400	11,900	10,700	9,800	9,100	14,200	12,200	10,600	9,700
90	8,900	8,600	8,300	8,200	11,300	10,300	9,400	8,900	13,500	11,700	10,300	9,400
95	8,500	8,200	8,000		10,800	9,900	9,100	8,700	12,900	11,300	10,000	9,200
100	8,100	7,900			10,300	9,500	8,900	8,500	12,400	10,900	9,700	9,000
105					9,800	9,100	8,600	8,300	11,800	10,500	9,500	8,900
110					9,400	8,800	8,400	8,200	11,400	10,200	9,200	8,700
115					9,000	8,500	8,200	8,200	10,900	9,800	9,000	8,500
120					8,700	8,300	8,000		10,500	9,500	8,800	8,400
125					8,300	8,100	8,000		10,100	9,300	8,600	8,300
130									9,800	9,000	8,400	8,200
135									9,400	8,800	8,300	8,200
140									9,100	8,500	8,200	8,200
145									8,800	8,300	8,000	
150									8,500	8,100	8,000	
155									8,300	8,000		
Min Angle	0.0	0.0	0.0	0.0	14.0	18.5	0.0	0.0	15.5	18.5	27.0	11.5
Max Rad.	102.9	102.7	100.7	96.8	130.0	130.0	128.9	123.9	160.0	160.0	155.0	146.4
Capacity	6,200	6,400	7,000	8,200	0	0	2,000	2,300	0	0	0	0

1041070



PORTLAND OFFICE: 503.283.3111
 SEATTLE OFFICE: 206.784.1054
WWW.NESSCAMPBELL.COM

Rated Lifting Capacities in Pounds

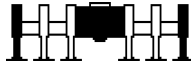

Full

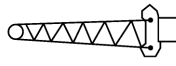

67ft Offset Fly



58,000 lbs



Radius (ft)	Boom Length (ft)											
	Fly Offset											
	134.9				167.1				183.6			
	2°	15°	30°	45°	2°	15°	30°	45°	2°	15°	30°	45°
30	15,900											
35	15,900				13,300							
40	15,900				13,300				12,400			
45	15,900	15,800			13,300				12,400			
50	15,900	15,800			13,300				12,400			
55	15,900	15,800			13,300	13,300			12,400			
60	15,900	15,800	13,300		13,300	13,300			12,400	12,300		
65	15,900	15,800	12,900		13,300	13,300			12,400	12,300		
70	15,900	15,100	12,400		13,300	13,300	13,000		12,400	12,300		
75	15,900	14,500	12,100	10,500	13,300	13,300	12,600		12,400	12,300	12,300	
80	15,900	14,000	11,700	10,300	13,300	13,300	12,300	10,600	12,400	12,300	12,300	
85	15,900	13,500	11,400	10,100	13,300	13,300	12,000	10,400	12,400	12,300	12,200	
90	15,700	13,000	11,100	9,800	13,300	13,300	11,600	10,200	12,400	12,300	11,900	10,300
95	15,000	12,600	10,800	9,600	13,300	13,300	11,400	10,000	12,400	12,300	11,600	10,100
100	14,400	12,100	10,500	9,500	13,300	13,300	11,100	9,800	12,400	12,300	11,400	10,000
105	13,800	11,700	10,200	9,300	13,300	12,900	10,800	9,600	12,400	12,300	11,100	9,800
110	13,300	11,400	10,000	9,100	13,300	12,500	10,600	9,500	12,400	12,300	10,900	9,600
115	12,800	11,000	9,700	9,000	13,300	12,100	10,400	9,300	12,400	12,300	10,600	9,500
120	12,300	10,700	9,500	8,800	13,100	11,800	10,100	9,200	12,000	12,300	10,400	9,300
125	11,900	10,400	9,300	8,700	12,000	11,500	9,900	9,000	10,900	12,000	10,200	9,200
130	11,400	10,100	9,100	8,600	10,900	11,200	9,700	8,900	9,900	11,000	10,000	9,100
135	11,100	9,900	8,900	8,500	10,000	10,900	9,500	8,800	8,900	10,000	9,800	9,000
140	10,700	9,600	8,800	8,400	9,100	10,000	9,400	8,700	8,100	9,000	9,600	8,900
145	9,900	9,400	8,600	8,300	8,300	9,100	9,200	8,600	7,300	8,200	9,100	8,700
150	9,100	9,100	8,500	8,200	7,600	8,300	9,000	8,500	6,500	7,400	8,200	8,600
155	8,400	8,900	8,300	8,200	6,900	7,600	8,300	8,400	5,800	6,600	7,400	8,000
160	7,800	8,200	8,200	8,100	6,200	6,900	7,500	7,900	5,200	5,900	6,700	7,200
165	7,200	7,600	7,900	8,000	5,600	6,200	6,800	7,200	4,600	5,300	6,000	6,400
170	6,600	7,000	7,200		5,100	5,600	6,200	6,400	4,000	4,700	5,300	5,700
175	6,100	6,400	6,600		4,500	5,100	5,500	5,800	3,500	4,100	4,700	5,100
180	5,600	5,900	6,000		4,000	4,500	5,000	5,100	3,000	3,600	4,100	4,400
185	5,200	5,300			3,600	4,000	4,400	4,500	2,500	3,100	3,600	3,800
190					3,200	3,600	3,900	4,000	2,100	2,600	3,100	3,300
195					2,700	3,100	3,400			2,200	2,600	2,700
200					2,400	2,700	2,900				2,100	2,200
205						2,300	2,400					
Min Angle	16.5	19.0	25.5	14.5	30.0	30.0	30.0	29.0	42.5	43.5	44.0	44.0
Max Rad. Capacity	190.0	190.0	185.0	177.6	205.0	208.8	210.0	208.0	191.3	197.0	201.0	202.0
	0	0	0	0	0	0	0	0	0	0	0	0

1041070



PORTLAND OFFICE: 503.283.3111
 SEATTLE OFFICE: 206.784.1054
WWW.NESSCAMPBELL.COM

Rated Lifting Capacities in Pounds

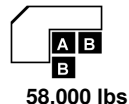
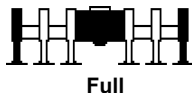

Radius (ft)	Boom Length (ft)			
	Fly Offset			
	200.1			
	2°	15°	30°	45°
45	10,800			
50	10,800			
55	10,800			
60	10,800			
65	10,800	10,800		
70	10,800	10,800		
75	10,800	10,800		
80	10,800	10,800	10,700	
85	10,800	10,800	10,700	
90	10,800	10,800	10,700	
95	10,800	10,800	10,700	10,300
100	10,800	10,800	10,700	10,100
105	10,800	10,800	10,700	9,900
110	10,800	10,800	10,700	9,800
115	10,800	10,800	10,700	9,600
120	10,800	10,800	10,700	9,500
125	10,000	10,800	10,500	9,400
130	8,900	10,100	10,300	9,200
135	8,000	9,100	10,100	9,100
140	7,100	8,200	9,300	9,000
145	6,300	7,300	8,300	8,900
150	5,600	6,500	7,500	8,200
155	4,900	5,800	6,700	7,300
160	4,300	5,100	5,900	6,500
165	3,700	4,500	5,200	5,800
170	3,100	3,900	4,600	5,100
175	2,600	3,300	4,000	4,400
180	2,100	2,800	3,400	3,800
185		2,300	2,800	3,200
190			2,300	2,600
195				2,100
Min Angle	51.0	51.5	52.0	52.0
Max Rad.	181.0	188.0	193.0	196.0
Capacity	0	0	0	0

1041070



PORTLAND OFFICE: 503.283.3111
 SEATTLE OFFICE: 206.784.1054
WWW.NESSCAMPBELL.COM

Rated Lifting Capacities in Pounds

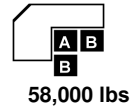
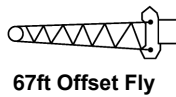
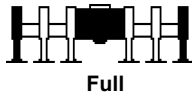

Radius (ft)	Boom Length (ft)											
	Fly Offset											
	44.3				58.9				89.1			
	2°	15°	30°	45°	2°	15°	30°	45°	2°	15°	30°	45°
15	30,000											
20	27,800				30,000				28,400			
25	24,600	19,800			26,900				28,400			
30	21,100	18,100			24,100	19,100			28,100			
35	19,100	16,600			21,100	17,700			25,600	19,300		
40	17,400	15,400	13,700		19,300	16,400			23,500	18,100		
45	16,000	14,300	12,800		17,800	15,300	13,300		21,100	17,000		
50	14,800	13,300	12,100		16,500	14,400	12,600		19,700	16,100	13,400	
55	13,800	12,500	11,400	10,600	15,400	13,500	12,000	10,900	18,400	15,200	12,900	
60	12,800	11,700	10,800	10,100	14,400	12,700	11,400	10,400	17,300	14,500	12,300	10,900
65	12,000	11,100	10,300	9,700	13,500	12,100	10,900	10,000	16,300	13,800	11,800	10,600
70	11,200	10,500	9,800	9,300	12,700	11,400	10,400	9,700	15,300	13,100	11,400	10,300
75	10,600	9,900	9,300	8,900	11,900	10,900	10,000	9,300	14,500	12,500	11,000	10,000
80	10,000	9,400	8,900	8,600	11,300	10,400	9,600	9,000	13,800	12,000	10,600	9,700
85	9,400	9,000	8,600	8,400	10,700	9,900	9,200	8,800	13,100	11,500	10,200	9,400
90	8,900	8,600	8,300	8,200	10,200	9,500	8,900	8,600	12,500	11,100	9,900	9,200
95	8,500	8,200	8,000		9,700	9,100	8,600	8,400	11,900	10,600	9,600	9,000
100	8,100	7,900			9,200	8,700	8,300	8,200	11,400	10,200	9,300	8,800
105					8,800	8,400	8,100		10,900	9,900	9,100	8,600
110					8,400	8,100	8,000		10,400	9,500	8,800	8,500
115					8,100	7,900			10,000	9,200	8,600	8,300
120									9,600	8,900	8,400	8,200
125									9,300	8,700	8,300	8,200
130									8,900	8,400	8,100	
135									8,600	8,200	8,000	
140									8,300	8,000	8,000	
145									8,100	7,900		
Min Angle	0.0	0.0	0.0	0.0	0.0	0.0	0.0	0.0	0.0	0.0	0.0	0.0
Max Rad.	102.9	102.7	100.7	96.8	117.5	117.1	114.7	110.2	147.7	147.1	144.1	138.7
Capacity	6,200	6,400	7,000	8,200	3,600	3,700	4,100	4,700	2,600	2,600	2,900	3,400

1041080



PORTLAND OFFICE: 503.283.3111
 SEATTLE OFFICE: 206.784.1054
WWW.NESSCAMPBELL.COM

Rated Lifting Capacities in Pounds

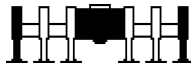

Full

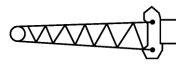

67ft Offset Fly



58,000 lbs



Radius (ft)	Boom Length (ft)											
	Fly Offset											
	120.3				152.4				169.0			
	2°	15°	30°	45°	2°	15°	30°	45°	2°	15°	30°	45°
25	19,500											
30	19,500											
35	19,500				16,600				15,500			
40	19,500				16,600				15,500			
45	19,500	18,400			16,600				15,500			
50	19,500	17,500			16,600	16,500			15,500			
55	19,500	16,600	13,500		16,600	16,500			15,500	15,500		
60	19,500	15,900	13,000		16,600	16,500			15,500	15,500		
65	18,900	15,200	12,600		16,600	16,400	13,100		15,500	15,500		
70	17,900	14,500	12,200	10,700	16,600	15,800	12,700		15,500	15,500	13,000	
75	17,000	14,000	11,800	10,400	16,600	15,200	12,400	10,700	15,500	15,500	12,600	
80	16,100	13,400	11,400	10,100	16,600	14,600	12,000	10,500	15,500	15,200	12,300	
85	15,400	12,900	11,100	9,900	16,600	14,100	11,700	10,200	15,500	14,700	12,000	10,400
90	14,700	12,400	10,700	9,700	16,600	13,600	11,400	10,000	15,500	14,200	11,700	10,200
95	14,000	12,000	10,400	9,500	16,100	13,200	11,100	9,800	15,500	13,700	11,400	10,000
100	13,400	11,600	10,200	9,300	15,400	12,800	10,800	9,700	15,500	13,300	11,100	9,800
105	12,900	11,200	9,900	9,100	14,800	12,400	10,600	9,500	15,500	12,900	10,900	9,700
110	12,400	10,800	9,600	8,900	14,300	12,000	10,300	9,300	14,300	12,500	10,600	9,500
115	11,900	10,500	9,400	8,800	13,700	11,600	10,100	9,200	13,000	12,200	10,400	9,300
120	11,500	10,200	9,200	8,600	12,900	11,300	9,900	9,000	11,700	11,800	10,200	9,200
125	11,100	9,900	9,000	8,500	11,700	11,000	9,700	8,900	10,600	11,500	10,000	9,100
130	10,700	9,600	8,800	8,400	10,700	10,700	9,500	8,800	9,600	10,700	9,800	8,900
135	10,300	9,300	8,600	8,300	9,800	10,400	9,300	8,700	8,600	9,700	9,600	8,800
140	10,000	9,100	8,500	8,200	8,900	9,700	9,100	8,500	7,800	8,700	9,400	8,700
145	9,600	8,900	8,300	8,200	8,100	8,900	8,900	8,500	7,000	7,900	8,800	8,600
150	9,000	8,700	8,200	8,200	7,300	8,100	8,800	8,400	6,200	7,100	7,900	8,500
155	8,300	8,500	8,100		6,700	7,300	7,900	8,300	5,500	6,300	7,100	7,600
160	7,600	8,000	8,000		6,000	6,600	7,200	7,500	4,900	5,600	6,300	6,800
165	7,000	7,300	7,500		5,400	6,000	6,500	6,700	4,300	5,000	5,600	6,000
170	6,500	6,700			4,900	5,400	5,800	6,000	3,800	4,400	5,000	5,300
175					4,300	4,800	5,200	5,300	3,200	3,800	4,400	4,600
180					3,800	4,300	4,600		2,700	3,300	3,800	4,000
185					3,400	3,800	4,000		2,300	2,800	3,200	3,400
190					2,900	3,300	3,500			2,300	2,700	2,800
195					2,500	2,800	3,000				2,200	
200					2,200	2,400						
Min Angle	17.0	19.5	27.0	3.5	20.5	21.0	20.5	28.5	39.0	39.0	39.5	39.0
Max Rad. Capacity	175.0	175.0	170.0	163.0	202.5	205.0	204.0	195.0	188.0	193.8	197.0	197.0
	0	0	0	0	0	0	0	0	0	0	0	0

1041080



PORTLAND OFFICE: 503.283.3111
 SEATTLE OFFICE: 206.784.1054
WWW.NESSCAMPBELL.COM

Rated Lifting Capacities in Pounds

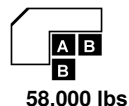
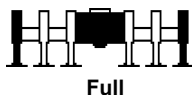

Radius (ft)	Boom Length (ft)			
	Fly Offset			
	185.5			
	2°	15°	30°	45°
40	13,500			
45	13,500			
50	13,500			
55	13,500			
60	13,500	13,500		
65	13,500	13,500		
70	13,500	13,500		
75	13,500	13,500	12,900	
80	13,500	13,500	12,500	
85	13,500	13,500	12,200	
90	13,500	13,500	11,900	10,300
95	13,500	13,500	11,700	10,100
100	13,500	13,500	11,400	10,000
105	13,500	13,400	11,100	9,800
110	13,300	13,000	10,900	9,600
115	12,000	12,700	10,700	9,500
120	10,800	12,100	10,500	9,400
125	9,600	10,900	10,200	9,200
130	8,600	9,800	10,000	9,100
135	7,700	8,800	9,900	9,000
140	6,800	7,900	8,900	8,900
145	6,000	7,000	8,000	8,700
150	5,300	6,200	7,100	7,800
155	4,600	5,500	6,300	7,000
160	4,000	4,800	5,600	6,100
165	3,400	4,100	4,900	5,400
170	2,800	3,500	4,200	4,700
175	2,300	3,000	3,600	4,000
180		2,400	3,000	3,400
185			2,500	2,800
190				2,200
Min Angle	48.0	49.0	49.0	49.0
Max Rad.	178.0	184.0	190.0	191.7
Capacity	0	0	0	0

1041080



PORTLAND OFFICE: 503.283.3111
 SEATTLE OFFICE: 206.784.1054
WWW.NESSCAMPBELL.COM

Rated Lifting Capacities in Pounds

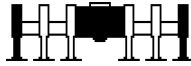

Full

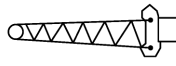

67ft Offset Fly



58,000 lbs



Radius (ft)	Boom Length (ft)											
	Fly Offset											
	44.3				73.5				103.8			
	2°	15°	30°	45°	2°	15°	30°	45°	2°	15°	30°	45°
15	30,000											
20	27,800				27,500							
25	24,600	19,800			27,500							
30	21,100	18,100			21,400				18,200			
35	19,100	16,600			21,400	18,500			18,200			
40	17,400	15,400	13,700		21,100	17,300			18,200			
45	16,000	14,300	12,800		19,500	16,200	13,700		18,200	17,700		
50	14,800	13,300	12,100		18,100	15,300	13,100		18,200	16,800		
55	13,800	12,500	11,400	10,600	16,900	14,400	12,400		18,200	15,900	13,200	
60	12,800	11,700	10,800	10,100	15,800	13,600	11,900	10,700	18,200	15,200	12,700	
65	12,000	11,100	10,300	9,700	14,900	12,900	11,400	10,300	17,500	14,500	12,200	10,800
70	11,200	10,500	9,800	9,300	14,000	12,300	10,900	10,000	16,600	13,800	11,800	10,500
75	10,600	9,900	9,300	8,900	13,200	11,700	10,500	9,700	15,700	13,200	11,400	10,200
80	10,000	9,400	8,900	8,600	12,500	11,200	10,100	9,400	14,900	12,700	11,000	9,900
85	9,400	9,000	8,600	8,400	11,900	10,700	9,800	9,100	14,200	12,200	10,600	9,700
90	8,900	8,600	8,300	8,200	11,300	10,300	9,400	8,900	13,500	11,700	10,300	9,400
95	8,500	8,200	8,000		10,800	9,900	9,100	8,700	12,900	11,300	10,000	9,200
100	8,100	7,900			10,300	9,500	8,900	8,500	12,400	10,900	9,700	9,000
105					9,800	9,100	8,600	8,300	11,800	10,500	9,500	8,900
110					9,400	8,800	8,400	8,200	11,400	10,200	9,200	8,700
115					9,000	8,500	8,200	8,200	10,900	9,800	9,000	8,500
120					8,700	8,300	8,000		10,500	9,500	8,800	8,400
125					8,300	8,100	8,000		10,100	9,300	8,600	8,300
130									9,800	9,000	8,400	8,200
135									9,400	8,800	8,300	8,200
140									9,100	8,500	8,200	8,200
145									8,800	8,300	8,000	
150									8,500	8,100	8,000	
155									8,300	8,000		
Min Angle	0.0	0.0	0.0	0.0	14.0	18.5	0.0	0.0	15.5	18.5	27.0	11.5
Max Rad.	102.9	102.7	100.7	96.8	130.0	130.0	128.9	123.9	160.0	160.0	155.0	146.4
Capacity	6,200	6,400	7,000	8,200	0	0	2,000	2,300	0	0	0	0

1041090



PORTLAND OFFICE: 503.283.3111
 SEATTLE OFFICE: 206.784.1054
WWW.NESSCAMPBELL.COM

Rated Lifting Capacities in Pounds

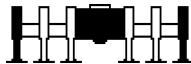

Full

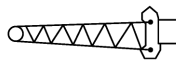

67ft Offset Fly



58,000 lbs



360°



Radius (ft)	Boom Length (ft)											
	Fly Offset											
	119.4				135.4				152.0			
	2°	15°	30°	45°	2°	15°	30°	45°	2°	15°	30°	45°
30	17,800											
35	17,800				18,100				17,400			
40	17,800				18,100				17,400			
45	17,800				18,100	18,000			17,400			
50	17,800	17,400			18,100	18,000			17,400	17,300		
55	17,800	16,600			18,100	17,200			17,400	17,300		
60	17,800	15,800	13,000		18,100	16,500	13,300		17,400	17,100		
65	17,800	15,200	12,600		18,100	15,800	12,900		17,400	16,400	13,100	
70	17,800	14,500	12,100	10,600	18,100	15,100	12,500		17,400	15,700	12,700	
75	16,900	13,900	11,700	10,400	18,000	14,500	12,100	10,500	17,400	15,200	12,400	10,700
80	16,100	13,400	11,400	10,100	17,200	14,000	11,700	10,300	17,400	14,600	12,000	10,500
85	15,300	12,900	11,000	9,900	16,400	13,500	11,400	10,100	17,400	14,100	11,700	10,200
90	14,600	12,400	10,700	9,700	15,700	13,000	11,100	9,900	16,700	13,600	11,400	10,000
95	14,000	12,000	10,400	9,400	15,000	12,600	10,800	9,600	16,000	13,200	11,100	9,800
100	13,400	11,500	10,100	9,300	14,400	12,200	10,500	9,500	15,400	12,700	10,800	9,600
105	12,800	11,200	9,900	9,100	13,800	11,800	10,200	9,300	14,800	12,400	10,600	9,500
110	12,300	10,800	9,600	8,900	13,300	11,400	10,000	9,100	14,200	12,000	10,300	9,300
115	11,900	10,500	9,400	8,800	12,800	11,100	9,700	9,000	13,700	11,600	10,100	9,200
120	11,400	10,200	9,200	8,600	12,300	10,700	9,500	8,800	12,900	11,300	9,900	9,000
125	11,000	9,900	9,000	8,500	11,900	10,400	9,300	8,700	11,800	11,000	9,600	8,900
130	10,600	9,600	8,800	8,400	11,500	10,100	9,100	8,600	10,800	10,700	9,500	8,800
135	10,300	9,300	8,600	8,300	11,100	9,900	8,900	8,500	9,800	10,400	9,300	8,700
140	9,900	9,100	8,500	8,200	10,300	9,600	8,800	8,400	9,000	9,800	9,100	8,500
145	9,600	8,800	8,300	8,200	9,400	9,400	8,600	8,300	8,100	8,900	8,900	8,500
150	9,300	8,600	8,200	8,200	8,700	9,100	8,500	8,200	7,400	8,100	8,800	8,400
155	8,900	8,400	8,100		8,000	8,500	8,300	8,200	6,700	7,400	8,000	8,300
160	8,300	8,300	8,000		7,400	7,800	8,200	8,100	6,100	6,700	7,200	7,600
165	7,700	8,000	8,000		6,800	7,200	7,500	7,600	5,500	6,000	6,500	6,800
170	7,200	7,400			6,200	6,600	6,900		4,900	5,400	5,900	6,100
175					5,700	6,000	6,200		4,400	4,900	5,200	5,400
180					5,200	5,500	5,600		3,900	4,300	4,600	
185					4,700	4,900			3,400	3,800	4,100	
190									3,000	3,300	3,500	
195									2,600	2,900	3,000	
200									2,200	2,400		
Min Angle	16.0	18.5	26.0	12.5	16.5	19.0	25.5	12.5	19.0	19.5	12.0	12.5
Max Rad. Capacity	175.0	175.0	170.0	162.0	190.0	190.0	185.0	178.1	203.3	205.0	203.6	194.6
Capacity	0	0	0	0	0	0	0	0	0	0	0	0

1041090



PORTLAND OFFICE: 503.283.3111
 SEATTLE OFFICE: 206.784.1054
WWW.NESSCAMPBELL.COM

Rated Lifting Capacities in Pounds

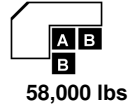
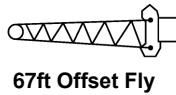
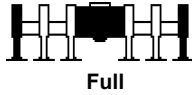

Radius (ft)	Boom Length (ft)			
	Fly Offset			
	168.5			
	2°	15°	30°	45°
35	15,300			
40	15,300			
45	15,300			
50	15,300			
55	15,300	15,200		
60	15,300	15,200		
65	15,300	15,200		
70	15,300	15,200	13,000	
75	15,300	15,200	12,600	
80	15,300	15,200	12,300	
85	15,300	14,600	12,000	10,400
90	15,300	14,200	11,700	10,200
95	15,300	13,700	11,400	10,000
100	15,300	13,300	11,100	9,800
105	15,300	12,900	10,900	9,600
110	14,400	12,500	10,600	9,500
115	13,000	12,200	10,400	9,300
120	11,800	11,800	10,200	9,200
125	10,700	11,500	10,000	9,100
130	9,600	10,700	9,800	8,900
135	8,700	9,700	9,600	8,800
140	7,800	8,800	9,400	8,700
145	7,000	7,900	8,800	8,600
150	6,300	7,100	7,900	8,500
155	5,600	6,400	7,100	7,600
160	5,000	5,700	6,400	6,800
165	4,400	5,000	5,700	6,100
170	3,800	4,400	5,000	5,300
175	3,300	3,900	4,400	4,700
180	2,800	3,300	3,800	4,000
185	2,300	2,800	3,300	3,400
190		2,400	2,700	2,800
195			2,200	
Min Angle	38.0	38.5	39.0	38.5
Max Rad.	188.8	194.0	197.0	197.5
Capacity	0	0	0	0

1041090



PORTLAND OFFICE: 503.283.3111
 SEATTLE OFFICE: 206.784.1054
WWW.NESSCAMPBELL.COM

Rated Lifting Capacities in Pounds

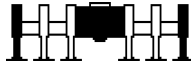

Full

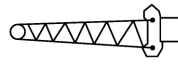

67ft Hydraulic Offset Fly



58,000 lbs



Radius (ft)	Boom Length (ft)											
	Fly Offset											
	44.3			73.5			103.8			134.9		
	2°-15°	15°-30°	30°-45°	2°-15°	15°-30°	30°-45°	2°-15°	15°-30°	30°-45°	2°-15°	15°-30°	30°-45°
15	30,000											
20	27,800			27,500								
25	19,800	19,800		27,500			18,200					
30	18,100	18,100		19,900	19,900		18,200			15,900		
35	16,600	16,600		18,500	18,500		18,200			15,900		
40	15,400	13,700	13,700	17,300	17,300		18,100	18,100		15,900		
45	14,300	12,800	12,800	16,200	13,700	13,700	17,700	17,700		15,800	15,800	
50	13,300	12,100	11,100	15,300	13,100	13,100	16,800	13,800	13,800	15,800	15,800	
55	12,500	11,400	10,600	14,400	12,400	11,100	15,900	13,200	13,200	15,800	15,800	
60	11,700	10,800	10,100	13,600	11,900	10,700	15,200	12,700	12,700	15,800	13,300	13,300
65	11,100	10,300	9,700	12,900	11,400	10,300	14,500	12,200	10,800	15,800	12,900	12,900
70	10,500	9,800	9,300	12,300	10,900	10,000	13,800	11,800	10,500	15,100	12,400	10,800
75	9,900	9,300	8,900	11,700	10,500	9,700	13,200	11,400	10,200	14,500	12,100	10,500
80	9,400	8,900	8,600	11,200	10,100	9,400	12,700	11,000	9,900	14,000	11,700	10,300
85	9,000	8,600	8,400	10,700	9,800	9,100	12,200	10,600	9,700	13,500	11,400	10,100
90	8,600	8,300	8,200	10,300	9,400	8,900	11,700	10,300	9,400	13,000	11,100	9,800
95	8,200	8,000	8,000	9,900	9,100	8,700	11,300	10,000	9,200	12,600	10,800	9,600
100	7,900	7,900		9,500	8,900	8,500	10,900	9,700	9,000	12,100	10,500	9,500
105				9,100	8,600	8,300	10,500	9,500	8,900	11,700	10,200	9,300
110				8,800	8,400	8,200	10,200	9,200	8,700	11,400	10,000	9,100
115				8,500	8,200	8,200	9,800	9,000	8,500	11,000	9,700	9,000
120				8,300	8,000	8,000	9,500	8,800	8,400	10,700	9,500	8,800
125				8,100	8,000	8,000	9,300	8,600	8,300	10,400	9,300	8,700
130							9,000	8,400	8,200	10,100	9,100	8,600
135							8,800	8,300	8,200	9,900	8,900	8,500
140							8,500	8,200	8,200	9,600	8,800	8,400
145							8,300	8,000	8,000	9,400	8,600	8,300
150							8,100	8,000		9,100	8,500	8,200
155							8,000			8,400	8,300	8,200
160										7,800	8,200	8,100
165										7,200	7,600	7,900
170										6,600	7,000	7,200
175										6,100	6,400	6,500
180										5,600	5,900	
185										5,200		
Min Angle	0.0	0.0	0.0	14.0	18.5	0.0	15.5	27.0	11.5	16.5	25.5	14.5
Max Rad.	102.9	102.7	100.7	130.0	130.0	128.9	160.0	155.0	146.4	190.0	185.0	177.6
Capacity	6,200	6,400	7,000	0	0	2,000	0	0	0	0	0	0

1042070



PORTLAND OFFICE: 503.283.3111
 SEATTLE OFFICE: 206.784.1054
WWW.NESSCAMPBELL.COM

Rated Lifting Capacities in Pounds

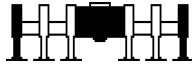

Full

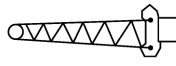

67ft Hydraulic Offset Fly



58,000 lbs



Boom Length (ft)									
Fly Offset									
Radius (ft)	167.1			183.6			200.1		
	2°-15°	15°-30°	30°-45°	2°-15°	15°-30°	30°-45°	2°-15°	15°-30°	30°-45°
35	13,300								
40	13,300			12,400					
45	13,300			12,400			10,800		
50	13,200	13,200		12,400			10,800		
55	13,200	13,200		12,300	12,300		10,800		
60	13,200	13,200		12,300	12,300		10,800	10,800	
65	13,200	13,200	13,200	12,300	12,300		10,800	10,800	
70	13,200	13,000	13,000	12,300	12,200	12,200	10,800	10,800	
75	13,200	12,600	12,600	12,300	12,200	12,200	10,800	10,700	10,700
80	13,200	12,300	10,600	12,300	12,200	12,200	10,800	10,700	10,700
85	13,200	12,000	10,400	12,300	12,200	10,500	10,800	10,700	10,700
90	13,200	11,600	10,200	12,300	11,900	10,300	10,800	10,700	10,400
95	13,200	11,400	10,000	12,300	11,600	10,100	10,800	10,700	10,300
100	13,200	11,100	9,800	12,300	11,400	10,000	10,800	10,700	10,100
105	12,900	10,800	9,600	12,300	11,100	9,800	10,800	10,700	9,900
110	12,500	10,600	9,500	12,300	10,900	9,600	10,800	10,700	9,800
115	12,100	10,400	9,300	12,300	10,600	9,500	10,800	10,700	9,600
120	11,800	10,100	9,200	12,000	10,400	9,300	10,800	10,700	9,500
125	11,500	9,900	9,000	10,900	10,200	9,200	10,000	10,500	9,400
130	10,900	9,700	8,900	9,900	10,000	9,100	8,900	10,100	9,200
135	10,000	9,500	8,800	8,900	9,800	9,000	8,000	9,100	9,100
140	9,100	9,400	8,700	8,100	9,000	8,900	7,100	8,200	9,000
145	8,300	9,100	8,600	7,300	8,200	8,700	6,300	7,300	8,300
150	7,600	8,300	8,500	6,500	7,400	8,200	5,600	6,500	7,500
155	6,900	7,600	8,300	5,800	6,600	7,400	4,900	5,800	6,700
160	6,200	6,900	7,500	5,200	5,900	6,700	4,300	5,100	5,900
165	5,600	6,200	6,800	4,600	5,300	6,000	3,700	4,500	5,200
170	5,100	5,600	6,200	4,000	4,700	5,300	3,100	3,900	4,600
175	4,500	5,100	5,500	3,500	4,100	4,700	2,600	3,300	4,000
180	4,000	4,500	5,000	3,000	3,600	4,100	2,100	2,800	3,400
185	3,600	4,000	4,400	2,500	3,100	3,600		2,300	2,800
190	3,200	3,600	3,900	2,100	2,600	3,100			2,300
195	2,700	3,100	3,400		2,200	2,600			
200	2,400	2,700	2,900			2,100			
205		2,300	2,300						
Min Angle	30.0	30.0	29.0	42.5	43.5	44.0	51.0	51.5	52.0
Max Rad. Capacity	205.0	208.8	208.0	191.3	197.0	201.0	181.0	188.0	193.0
	0	0	0	0	0	0	0	0	0

1042070



PORTLAND OFFICE: 503.283.3111
 SEATTLE OFFICE: 206.784.1054
WWW.NESSCAMPBELL.COM

Rated Lifting Capacities in Pounds

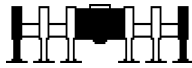

Full

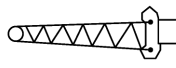

67ft Hydraulic Offset Fly



58,000 lbs



Radius (ft)	Boom Length (ft)											
	Fly Offset											
	44.3			58.9			89.1			120.3		
	2°-15°	15°-30°	30°-45°	2°-15°	15°-30°	30°-45°	2°-15°	15°-30°	30°-45°	2°-15°	15°-30°	30°-45°
15	30,000											
20	27,800			30,300			28,400					
25	19,800	19,800		26,900			28,400			19,500		
30	18,100	18,100		19,100	19,100		28,100			19,500		
35	16,600	16,600		17,700	17,700		19,300	19,300		19,500		
40	15,400	13,700	13,700	16,400	14,100	14,100	18,100	18,100		19,400	19,400	
45	14,300	12,800	12,800	15,300	13,300	13,300	17,000	14,100	14,100	18,400	18,400	
50	13,300	12,100	11,100	14,400	12,600	12,600	16,100	13,400	13,400	17,500	17,500	
55	12,500	11,400	10,600	13,500	12,000	10,900	15,200	12,900	12,900	16,600	13,500	13,500
60	11,700	10,800	10,100	12,700	11,400	10,400	14,500	12,300	10,900	15,900	13,000	13,000
65	11,100	10,300	9,700	12,100	10,900	10,000	13,800	11,800	10,600	15,200	12,600	10,900
70	10,500	9,800	9,300	11,400	10,400	9,700	13,100	11,400	10,300	14,500	12,200	10,700
75	9,900	9,300	8,900	10,900	10,000	9,300	12,500	11,000	10,000	14,000	11,800	10,400
80	9,400	8,900	8,600	10,400	9,600	9,000	12,000	10,600	9,700	13,400	11,400	10,100
85	9,000	8,600	8,400	9,900	9,200	8,800	11,500	10,200	9,400	12,900	11,100	9,900
90	8,600	8,300	8,200	9,500	8,900	8,600	11,100	9,900	9,200	12,400	10,700	9,700
95	8,200	8,000	8,000	9,100	8,600	8,400	10,600	9,600	9,000	12,000	10,400	9,500
100	7,900	7,900		8,700	8,300	8,200	10,200	9,300	8,800	11,600	10,200	9,300
105				8,400	8,100	8,100	9,900	9,100	8,600	11,200	9,900	9,100
110				8,100	8,000	8,000	9,500	8,800	8,500	10,800	9,600	8,900
115				7,900	7,900		9,200	8,600	8,300	10,500	9,400	8,800
120							8,900	8,400	8,200	10,200	9,200	8,600
125							8,700	8,300	8,200	9,900	9,000	8,500
130							8,400	8,100	8,100	9,600	8,800	8,400
135							8,200	8,000	8,000	9,300	8,600	8,300
140							8,000	8,000	8,000	9,100	8,500	8,200
145							7,900	7,900		8,900	8,300	8,200
150										8,700	8,200	8,200
155										8,300	8,100	8,100
160										7,600	8,000	8,000
165										7,000	7,300	
170										6,500		
Min Angle	0.0	0.0	0.0	0.0	0.0	0.0	0.0	0.0	0.0	17.0	27.0	3.5
Max Rad.	102.9	102.7	100.7	117.5	117.1	114.7	147.7	147.1	144.1	175.0	170.0	163.0
Capacity	6,200	6,400	7,000	3,600	3,700	4,100	2,600	2,600	2,900	0	0	0

1042080



PORTLAND OFFICE: 503.283.3111
 SEATTLE OFFICE: 206.784.1054
WWW.NESSCAMPBELL.COM

Rated Lifting Capacities in Pounds

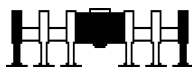

Full

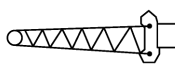

67ft Hydraulic Offset Fly



58,000 lbs



Radius (ft)	Boom Length (ft)								
	Fly Offset								
	152.4			169.0			185.5		
	2°-15°	15°-30°	30°-45°	2°-15°	15°-30°	30°-45°	2°-15°	15°-30°	30°-45°
35	16,600			15,500					
40	16,600			15,500			13,500		
45	16,600			15,500			13,500		
50	16,500	16,500		15,400	15,400		13,500		
55	16,500	16,500		15,400	15,400		13,500	13,500	
60	16,500	16,500		15,400	15,400		13,500	13,500	
65	16,400	13,100	13,100	15,400	13,400	13,400	13,500	13,500	
70	15,800	12,700	12,700	15,400	13,000	13,000	13,500	13,200	13,200
75	15,200	12,400	10,700	15,400	12,600	12,600	13,500	12,900	12,900
80	14,600	12,000	10,500	15,200	12,300	10,600	13,500	12,500	12,500
85	14,100	11,700	10,200	14,700	12,000	10,400	13,500	12,200	10,500
90	13,600	11,400	10,000	14,200	11,700	10,200	13,500	11,900	10,300
95	13,200	11,100	9,800	13,700	11,400	10,000	13,500	11,700	10,100
100	12,800	10,800	9,700	13,300	11,100	9,800	13,500	11,400	10,000
105	12,400	10,600	9,500	12,900	10,900	9,700	13,400	11,100	9,800
110	12,000	10,300	9,300	12,500	10,600	9,500	13,000	10,900	9,600
115	11,600	10,100	9,200	12,200	10,400	9,300	12,000	10,700	9,500
120	11,300	9,900	9,000	11,700	10,200	9,200	10,800	10,500	9,400
125	11,000	9,700	8,900	10,600	10,000	9,100	9,600	10,200	9,200
130	10,700	9,500	8,800	9,600	9,800	8,900	8,600	9,800	9,100
135	9,800	9,300	8,700	8,600	9,600	8,800	7,700	8,800	9,000
140	8,900	9,100	8,500	7,800	8,700	8,700	6,800	7,900	8,900
145	8,100	8,900	8,500	7,000	7,900	8,600	6,000	7,000	8,000
150	7,300	8,100	8,400	6,200	7,100	7,900	5,300	6,200	7,100
155	6,700	7,300	7,900	5,500	6,300	7,100	4,600	5,500	6,300
160	6,000	6,600	7,200	4,900	5,600	6,300	4,000	4,800	5,600
165	5,400	6,000	6,500	4,300	5,000	5,600	3,400	4,100	4,900
170	4,900	5,400	5,800	3,800	4,400	5,000	2,800	3,500	4,200
175	4,300	4,800	5,200	3,200	3,800	4,400	2,300	3,000	3,600
180	3,800	4,300	4,600	2,700	3,300	3,800		2,400	3,000
185	3,400	3,800	4,000	2,300	2,800	3,200			2,500
190	2,900	3,300	3,400		2,300	2,700			
195	2,500	2,800				2,200			
200	2,200	2,400							
Min Angle	20.5	20.5	28.5	39.0	39.0	39.0	48.0	49.0	49.0
Max Rad. Capacity	202.5	204.0	195.0	188.0	193.8	197.0	178.0	184.0	190.0
	0	0	0	0	0	0	0	0	0

1042080



PORTLAND OFFICE: 503.283.3111
 SEATTLE OFFICE: 206.784.1054
WWW.NESSCAMPBELL.COM

Rated Lifting Capacities in Pounds

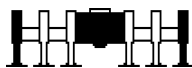

Full

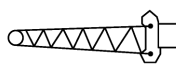

67ft Hydraulic Offset Fly



58,000 lbs



Radius (ft)	Boom Length (ft)											
	Fly Offset											
	44.3			73.5			103.8			119.4		
	2°-15°	15°-30°	30°-45°	2°-15°	15°-30°	30°-45°	2°-15°	15°-30°	30°-45°	2°-15°	15°-30°	30°-45°
15	30,000											
20	27,800			27,500								
25	19,800	19,800		27,500			18,200					
30	18,100	18,100		19,900	19,900		18,200			17,800		
35	16,600	16,600		18,500	18,500		18,200			17,800		
40	15,400	13,700	13,700	17,300	17,300		18,100	18,100		17,700	17,700	
45	14,300	12,800	12,800	16,200	13,700	13,700	17,700	17,700		17,700	17,700	
50	13,300	12,100	11,100	15,300	13,100	13,100	16,800	13,800	13,800	17,400	17,400	
55	12,500	11,400	10,600	14,400	12,400	11,100	15,900	13,200	13,200	16,600	13,500	13,500
60	11,700	10,800	10,100	13,600	11,900	10,700	15,200	12,700	12,700	15,800	13,000	13,000
65	11,100	10,300	9,700	12,900	11,400	10,300	14,500	12,200	10,800	15,200	12,600	12,600
70	10,500	9,800	9,300	12,300	10,900	10,000	13,800	11,800	10,500	14,500	12,100	10,600
75	9,900	9,300	8,900	11,700	10,500	9,700	13,200	11,400	10,200	13,900	11,700	10,400
80	9,400	8,900	8,600	11,200	10,100	9,400	12,700	11,000	9,900	13,400	11,400	10,100
85	9,000	8,600	8,400	10,700	9,800	9,100	12,200	10,600	9,700	12,900	11,000	9,900
90	8,600	8,300	8,200	10,300	9,400	8,900	11,700	10,300	9,400	12,400	10,700	9,700
95	8,200	8,000	8,000	9,900	9,100	8,700	11,300	10,000	9,200	12,000	10,400	9,400
100	7,900	7,900		9,500	8,900	8,500	10,900	9,700	9,000	11,500	10,100	9,300
105				9,100	8,600	8,300	10,500	9,500	8,900	11,200	9,900	9,100
110				8,800	8,400	8,200	10,200	9,200	8,700	10,800	9,600	8,900
115				8,500	8,200	8,200	9,800	9,000	8,500	10,500	9,400	8,800
120				8,300	8,000	8,000	9,500	8,800	8,400	10,200	9,200	8,600
125				8,100	8,000	8,000	9,300	8,600	8,300	9,900	9,000	8,500
130							9,000	8,400	8,200	9,600	8,800	8,400
135							8,800	8,300	8,200	9,300	8,600	8,300
140							8,500	8,200	8,200	9,100	8,500	8,200
145							8,300	8,000	8,000	8,800	8,300	8,200
150							8,100	8,000		8,600	8,200	8,200
155							8,000			8,400	8,100	8,100
160										8,300	8,000	8,000
165										7,700	8,000	
170										7,200		
Min Angle	0.0	0.0	0.0	14.0	18.5	0.0	15.5	27.0	11.5	16.0	26.0	12.5
Max Rad.	102.9	102.7	100.7	130.0	130.0	128.9	160.0	155.0	146.4	175.0	170.0	162.0
Capacity	6,200	6,400	7,000	0	0	2,000	0	0	0	0	0	0

1042090



PORTLAND OFFICE: 503.283.3111
 SEATTLE OFFICE: 206.784.1054
WWW.NESSCAMPBELL.COM

Rated Lifting Capacities in Pounds

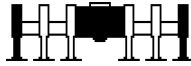

Full

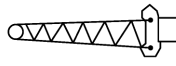

67ft Hydraulic Offset Fly



58,000 lbs



Radius (ft)	Boom Length (ft)								
	Fly Offset								
	135.4			152.0			168.5		
	2°-15°	15°-30°	30°-45°	2°-15°	15°-30°	30°-45°	2°-15°	15°-30°	30°-45°
35	18,100			17,400			15,300		
40	18,100			17,400			15,300		
45	18,000	18,000		17,400			15,300		
50	18,000	18,000		17,300	17,300		15,200	15,200	
55	17,200	17,200		17,300	17,300		15,200	15,200	
60	16,500	13,300	13,300	17,100	17,100		15,200	15,200	
65	15,800	12,900	12,900	16,400	13,100	13,100	15,200	15,200	
70	15,100	12,500	12,500	15,700	12,700	10,900	15,200	13,000	13,000
75	14,500	12,100	10,500	15,200	12,400	10,700	15,200	12,600	12,600
80	14,000	11,700	10,300	14,600	12,000	10,500	15,200	12,300	10,600
85	13,500	11,400	10,100	14,100	11,700	10,200	14,600	12,000	10,400
90	13,000	11,100	9,900	13,600	11,400	10,000	14,200	11,700	10,200
95	12,600	10,800	9,600	13,200	11,100	9,800	13,700	11,400	10,000
100	12,200	10,500	9,500	12,700	10,800	9,600	13,300	11,100	9,800
105	11,800	10,200	9,300	12,400	10,600	9,500	12,900	10,900	9,600
110	11,400	10,000	9,100	12,000	10,300	9,300	12,500	10,600	9,500
115	11,100	9,700	9,000	11,600	10,100	9,200	12,200	10,400	9,300
120	10,700	9,500	8,800	11,300	9,900	9,000	11,800	10,200	9,200
125	10,400	9,300	8,700	11,000	9,600	8,900	10,700	10,000	9,100
130	10,100	9,100	8,600	10,700	9,500	8,800	9,600	9,800	8,900
135	9,900	8,900	8,500	9,800	9,300	8,700	8,700	9,600	8,800
140	9,600	8,800	8,400	9,000	9,100	8,500	7,800	8,800	8,700
145	9,400	8,600	8,300	8,100	8,900	8,500	7,000	7,900	8,600
150	8,700	8,500	8,200	7,400	8,100	8,400	6,300	7,100	7,900
155	8,000	8,300	8,200	6,700	7,400	8,000	5,600	6,400	7,100
160	7,400	7,800	8,100	6,100	6,700	7,200	5,000	5,700	6,400
165	6,800	7,200	7,500	5,500	6,000	6,500	4,400	5,000	5,700
170	6,200	6,600	6,900	4,900	5,400	5,900	3,800	4,400	5,000
175	5,700	6,000	6,100	4,400	4,900	5,200	3,300	3,900	4,400
180	5,200	5,500		3,900	4,300	4,600	2,800	3,300	3,800
185	4,700			3,400	3,800	4,100	2,300	2,800	3,300
190				3,000	3,300	3,400		2,400	2,700
195				2,600	2,900				2,200
200				2,200	2,400				
Min Angle	16.5	25.5	12.5	19.0	12.0	12.5	38.0	38.5	39.0
Max Rad. Capacity	190.0	185.0	178.1	203.3	203.6	194.6	188.8	194.0	197.0
	0	0	0	0	0	0	0	0	0

1042090



PORTLAND OFFICE: 503.283.3111
 SEATTLE OFFICE: 206.784.1054
WWW.NESSCAMPBELL.COM

Rated Lifting Capacities in Pounds

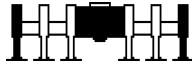

Full

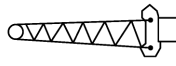

92ft Offset Fly



58,000 lbs



Radius (ft)	Boom Length (ft)											
	Fly Offset											
	44.3				73.5				103.8			
	2°	15°	30°	45°	2°	15°	30°	45°	2°	15°	30°	45°
20	19,800											
25	18,100				17,300							
30	16,700				17,300				15,200			
35	15,500	14,400			17,300				15,200			
40	14,400	13,400			16,300	14,600			15,200			
45	13,400	12,600	11,900		15,300	13,800			15,200	14,700		
50	12,600	11,800	11,200		14,400	13,100			15,200	14,000		
55	11,800	11,200	10,600		13,600	12,400	11,400		15,200	13,400		
60	11,100	10,500	10,000	9,700	12,900	11,800	10,900		14,400	12,800	11,500	
65	10,500	10,000	9,500	9,300	12,200	11,200	10,400	9,800	13,700	12,200	11,000	
70	9,900	9,500	9,100	8,800	11,600	10,700	10,000	9,400	13,100	11,700	10,600	9,800
75	9,400	9,000	8,700	8,400	11,000	10,200	9,500	9,100	12,500	11,300	10,200	9,500
80	8,900	8,600	8,300	8,100	10,500	9,800	9,200	8,700	12,000	10,800	9,900	9,200
85	8,400	8,100	7,800	7,700	10,000	9,400	8,800	8,400	11,500	10,400	9,500	8,900
90	7,900	7,700	7,400	7,300	9,600	9,000	8,500	8,200	11,000	10,000	9,200	8,700
95	7,400	7,200	7,100	7,000	9,200	8,700	8,200	7,900	10,600	9,700	8,900	8,400
100	7,000	6,800	6,700	6,600	8,800	8,300	7,800	7,600	10,200	9,300	8,600	8,200
105	6,500	6,400	6,300	6,300	8,400	7,900	7,500	7,300	9,800	9,000	8,400	8,000
110	6,100	6,000	6,000	6,000	8,000	7,600	7,200	7,000	9,400	8,700	8,100	7,700
115	5,800	5,700	5,700		7,600	7,200	6,900	6,800	9,100	8,400	7,800	7,500
120	5,400	5,400	5,400		7,200	6,900	6,600	6,500	8,800	8,100	7,600	7,300
125	5,100	5,100			6,800	6,500	6,300	6,300	8,400	7,800	7,300	7,100
130					6,500	6,200	6,100	6,100	8,100	7,500	7,100	6,900
135					6,100	6,000	5,800	5,900	7,700	7,200	6,800	6,700
140					5,800	5,700	5,600		7,400	6,900	6,600	6,400
145					5,600	5,500	5,400		7,000	6,700	6,400	6,300
150					5,300	5,200			6,700	6,400	6,200	6,100
155									6,400	6,200	6,000	5,900
160									6,200	5,900	5,800	5,800
165									5,900	5,700	5,600	
170									5,700	5,500	5,400	
175									5,500	5,300	5,300	
180									5,300	5,200		
Min Angle	0.0	0.0	0.0	0.0	14.0	17.0	26.5	26.0	15.5	17.5	25.0	22.5
Max Rad.	127.9	127.5	124.9	120.1	155.0	155.0	150.0	141.2	185.0	185.0	180.0	171.4
Capacity	3,100	3,100	3,400	3,900	0	0	0	0	0	0	0	0

1041100



PORTLAND OFFICE: 503.283.3111
 SEATTLE OFFICE: 206.784.1054
WWW.NESSCAMPBELL.COM

Rated Lifting Capacities in Pounds

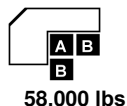
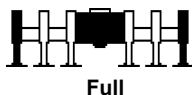

Radius (ft)	Boom Length (ft)											
	Fly Offset											
	134.9				167.1				183.6			
	2°	15°	30°	45°	2°	15°	30°	45°	2°	15°	30°	45°
35	12,900											
40	12,900											
45	12,900				10,400							
50	12,900				10,400				9,600			
55	12,900	12,800			10,400				9,600			
60	12,900	12,800			10,400	10,300			9,600			
65	12,900	12,800			10,400	10,300			9,600			
70	12,900	12,600	11,200		10,400	10,300			9,600	9,500		
75	12,900	12,200	10,800		10,400	10,300			9,600	9,500		
80	12,900	11,700	10,500	9,600	10,400	10,300	10,200		9,600	9,500		
85	12,800	11,300	10,100	9,300	10,400	10,300	10,200		9,600	9,500	9,400	
90	12,300	10,900	9,800	9,100	10,400	10,300	10,200	9,400	9,600	9,500	9,400	
95	11,800	10,600	9,500	8,900	10,400	10,300	10,100	9,200	9,600	9,500	9,400	9,300
100	11,400	10,200	9,300	8,600	10,400	10,300	9,800	9,000	9,600	9,500	9,400	9,100
105	11,000	9,900	9,000	8,400	10,400	10,300	9,500	8,800	9,600	9,500	9,400	9,000
110	10,600	9,600	8,800	8,200	10,400	10,300	9,300	8,600	9,600	9,500	9,400	8,800
115	10,300	9,300	8,500	8,000	10,400	10,100	9,100	8,400	9,600	9,500	9,300	8,600
120	9,900	9,000	8,300	7,800	10,400	9,800	8,900	8,300	9,600	9,500	9,100	8,400
125	9,600	8,800	8,100	7,600	10,400	9,600	8,700	8,100	9,600	9,500	8,900	8,300
130	9,300	8,500	7,900	7,400	10,400	9,300	8,500	7,900	9,600	9,500	8,700	8,100
135	9,000	8,300	7,600	7,300	10,000	9,100	8,300	7,700	8,900	9,400	8,500	8,000
140	8,700	8,000	7,400	7,100	9,100	8,800	8,100	7,600	8,000	9,100	8,300	7,800
145	8,400	7,700	7,200	6,900	8,300	8,600	7,900	7,400	7,200	8,200	8,200	7,600
150	8,100	7,500	7,000	6,700	7,500	8,300	7,700	7,200	6,500	7,400	8,000	7,500
155	7,800	7,200	6,800	6,600	6,800	7,600	7,500	7,100	5,800	6,600	7,500	7,300
160	7,500	7,000	6,600	6,400	6,100	6,900	7,300	7,000	5,100	5,900	6,800	7,200
165	7,100	6,800	6,400	6,300	5,500	6,200	6,900	6,800	4,500	5,300	6,100	6,600
170	6,500	6,500	6,200	6,100	5,000	5,600	6,200	6,700	3,900	4,700	5,400	5,900
175	6,000	6,300	6,000	6,000	4,400	5,000	5,600	6,000	3,400	4,100	4,800	5,200
180	5,500	5,900	5,900	5,900	3,900	4,500	5,000	5,400	2,900	3,600	4,200	4,600
185	5,000	5,400	5,700	5,700	3,500	4,000	4,500	4,800	2,400	3,100	3,700	4,000
190	4,600	4,900	5,100		3,000	3,500	4,000	4,200		2,600	3,100	3,500
195	4,100	4,400	4,600		2,600	3,100	3,500	3,700		2,100	2,600	2,900
200	3,800	4,000	4,100		2,200	2,600	3,000	3,200			2,200	2,400
205	3,400	3,600	3,700			2,200	2,600	2,700				
210	3,100	3,200					2,100	2,200				
Min Angle	16.5	19.0	25.0	19.5	42.0	42.5	43.5	43.0	51.0	51.5	52.0	51.5
Max Rad. Capacity	215.0	215.0	210.0	202.6	202.5	208.3	211.3	212.5	190.0	196.3	202.0	205.0
	0	0	0	0	0	0	0	0	0	0	0	0

1041100



PORTLAND OFFICE: 503.283.3111
 SEATTLE OFFICE: 206.784.1054
WWW.NESSCAMPBELL.COM

Rated Lifting Capacities in Pounds

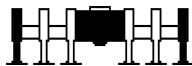

Full

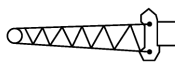

92ft Offset Fly



58,000 lbs



Radius (ft)	Boom Length (ft)			
	Fly Offset			
	200.1			
	2°	15°	30°	45°
55	8,200			
60	8,200			
65	8,200			
70	8,200			
75	8,200	8,100		
80	8,200	8,100		
85	8,200	8,100		
90	8,200	8,100	8,000	
95	8,200	8,100	8,000	
100	8,200	8,100	8,000	7,800
105	8,200	8,100	8,000	7,800
110	8,200	8,100	8,000	7,800
115	8,200	8,100	8,000	7,800
120	8,200	8,100	8,000	7,800
125	8,200	8,100	8,000	7,800
130	8,200	8,100	8,000	7,800
135	8,000	8,100	8,000	7,800
140	7,100	8,100	8,000	7,800
145	6,300	7,400	8,000	7,800
150	5,500	6,600	7,600	7,700
155	4,800	5,800	6,800	7,500
160	4,200	5,100	6,000	6,700
165	3,600	4,500	5,300	5,900
170	3,000	3,900	4,700	5,200
175	2,500	3,300	4,000	4,600
180		2,700	3,500	4,000
185		2,200	2,900	3,400
190			2,400	2,800
195				2,300
Min Angle	57.0	57.5	58.0	58.0
Max Rad.	180.0	187.5	194.0	198.0
Capacity	0	0	0	0

1041100



PORTLAND OFFICE: 503.283.3111
 SEATTLE OFFICE: 206.784.1054
WWW.NESSCAMPBELL.COM

Rated Lifting Capacities in Pounds

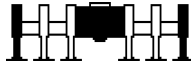

Full

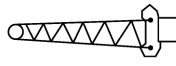

92ft Offset Fly



58,000 lbs



Radius (ft)	Boom Length (ft)											
	Fly Offset											
	44.3				58.9				89.1			
	2°	15°	30°	45°	2°	15°	30°	45°	2°	15°	30°	45°
20	19,800				19,700							
25	18,100				19,200				18,900			
30	16,700				17,700				18,900			
35	15,500	14,400			16,500	15,000			18,300			
40	14,400	13,400			15,400	14,100			17,100	15,100		
45	13,400	12,600	11,900		14,400	13,300			16,200	14,300		
50	12,600	11,800	11,200		13,500	12,500	11,600		15,300	13,600		
55	11,800	11,200	10,600		12,700	11,800	11,000		14,400	12,900	11,700	
60	11,100	10,500	10,000	9,700	12,000	11,200	10,500	10,000	13,700	12,300	11,200	
65	10,500	10,000	9,500	9,300	11,400	10,600	10,000	9,600	13,000	11,800	10,700	
70	9,900	9,500	9,100	8,800	10,800	10,100	9,600	9,200	12,400	11,300	10,300	9,700
75	9,400	9,000	8,700	8,400	10,200	9,600	9,100	8,800	11,800	10,800	9,900	9,300
80	8,900	8,600	8,300	8,100	9,700	9,200	8,700	8,400	11,300	10,400	9,600	9,000
85	8,400	8,100	7,800	7,700	9,300	8,800	8,400	8,100	10,800	9,900	9,200	8,700
90	7,900	7,700	7,400	7,300	8,900	8,400	8,000	7,800	10,300	9,600	8,900	8,400
95	7,400	7,200	7,100	7,000	8,400	8,000	7,700	7,500	9,900	9,200	8,600	8,200
100	7,000	6,800	6,700	6,600	8,000	7,600	7,300	7,200	9,500	8,900	8,300	7,900
105	6,500	6,400	6,300	6,300	7,500	7,200	7,000	6,900	9,200	8,500	8,000	7,700
110	6,100	6,000	6,000	6,000	7,100	6,800	6,600	6,600	8,800	8,200	7,700	7,400
115	5,800	5,700	5,700		6,700	6,500	6,300	6,300	8,400	7,900	7,400	7,200
120	5,400	5,400	5,400		6,300	6,200	6,000	6,000	8,000	7,600	7,200	7,000
125	5,100	5,100			6,000	5,800	5,800		7,700	7,200	6,900	6,700
130					5,700	5,600	5,500		7,300	6,900	6,600	6,500
135					5,400	5,300			7,000	6,600	6,400	6,300
140									6,600	6,300	6,100	6,100
145									6,300	6,100	5,900	5,900
150									6,000	5,800	5,700	
155									5,800	5,600	5,500	
160									5,500	5,400	5,400	
165									5,300	5,200		
Min Angle	0.0	0.0	0.0	0.0	14.5	18.5	28.5	9.5	15.0	18.0	26.0	18.5
Max Rad.	127.9	127.5	124.9	120.1	140.0	140.0	135.0	126.6	170.0	170.0	165.0	156.8
Capacity	3,100	3,100	3,400	3,900	0	0	0	0	0	0	0	0

1041110



PORTLAND OFFICE: 503.283.3111
 SEATTLE OFFICE: 206.784.1054
WWW.NESSCAMPBELL.COM

Rated Lifting Capacities in Pounds

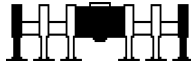

Full

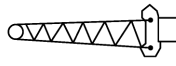

92ft Offset Fly



58,000 lbs



Radius (ft)	Boom Length (ft)											
	Fly Offset											
	120.3				152.4				169.0			
	2°	15°	30°	45°	2°	15°	30°	45°	2°	15°	30°	45°
35	16,500											
40	16,500				13,500							
45	16,500				13,500							
50	16,500	14,500			13,500				12,500			
55	15,900	13,900			13,500				12,500			
60	15,200	13,300			13,500	13,400			12,500			
65	14,500	12,700	11,300		13,500	13,400			12,500	12,400		
70	13,800	12,200	10,900		13,500	13,000			12,500	12,400		
75	13,200	11,800	10,500	9,700	13,500	12,600	11,100		12,500	12,400		
80	12,700	11,300	10,200	9,400	13,500	12,200	10,700		12,500	12,400	10,900	
85	12,200	10,900	9,900	9,200	13,400	11,800	10,400	9,500	12,500	12,100	10,700	
90	11,700	10,500	9,600	8,900	12,900	11,400	10,100	9,300	12,500	11,800	10,400	
95	11,200	10,200	9,300	8,700	12,500	11,000	9,800	9,100	12,500	11,400	10,100	9,200
100	10,800	9,800	9,000	8,400	12,000	10,700	9,600	8,800	12,500	11,100	9,800	9,000
105	10,400	9,500	8,700	8,200	11,600	10,300	9,300	8,600	12,200	10,700	9,600	8,800
110	10,100	9,200	8,500	8,000	11,200	10,000	9,100	8,400	11,800	10,400	9,300	8,600
115	9,700	8,900	8,300	7,800	10,900	9,800	8,800	8,300	11,400	10,100	9,100	8,500
120	9,400	8,600	8,000	7,600	10,500	9,500	8,600	8,100	11,100	9,900	8,900	8,300
125	9,100	8,400	7,700	7,400	10,200	9,200	8,400	7,900	10,700	9,600	8,700	8,100
130	8,800	8,100	7,500	7,200	9,900	9,000	8,200	7,700	9,700	9,300	8,500	7,900
135	8,400	7,800	7,300	7,000	9,600	8,700	8,000	7,500	8,700	9,100	8,300	7,800
140	8,100	7,500	7,100	6,800	8,900	8,500	7,800	7,400	7,900	8,900	8,100	7,600
145	7,800	7,300	6,800	6,600	8,100	8,200	7,600	7,200	7,000	8,000	7,900	7,400
150	7,500	7,000	6,600	6,500	7,400	8,000	7,400	7,000	6,300	7,200	7,700	7,300
155	7,200	6,700	6,400	6,300	6,700	7,400	7,200	6,900	5,600	6,500	7,300	7,100
160	6,900	6,500	6,200	6,100	6,000	6,700	7,000	6,700	4,900	5,800	6,600	7,000
165	6,600	6,300	6,000	6,000	5,400	6,100	6,700	6,600	4,300	5,100	5,800	6,400
170	6,400	6,100	5,900	5,800	4,800	5,500	6,100	6,400	3,800	4,500	5,200	5,600
175	5,900	5,900	5,700		4,300	4,900	5,400	5,700	3,200	3,900	4,600	5,000
180	5,400	5,700	5,500		3,800	4,400	4,800	5,100	2,700	3,400	4,000	4,300
185	5,000	5,300	5,400		3,300	3,800	4,300	4,500	2,300	2,900	3,400	3,700
190	4,500	4,800	4,900		2,900	3,400	3,800	3,900		2,400	2,900	3,200
195	4,100	4,300			2,500	2,900	3,300	3,400			2,400	2,600
200					2,100	2,500	2,800					2,100
205						2,100	2,300					
Min Angle	17.0	19.0	25.5	17.0	37.0	37.0	37.5	37.5	47.5	48.0	48.5	48.0
Max Rad. Capacity	200.0	200.0	195.0	188.0	201.3	206.3	208.8	208.0	188.0	194.0	199.0	201.0
Capacity	0	0	0	0	0	0	0	0	0	0	0	0

1041110



PORTLAND OFFICE: 503.283.3111
 SEATTLE OFFICE: 206.784.1054
WWW.NESSCAMPBELL.COM

Rated Lifting Capacities in Pounds

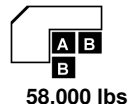
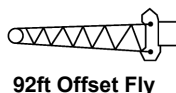
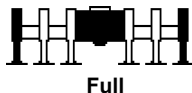

Radius (ft)	Boom Length (ft)			
	Fly Offset			
	185.5			
	2°	15°	30°	45°
50	10,700			
55	10,700			
60	10,700			
65	10,700			
70	10,700	10,600		
75	10,700	10,600		
80	10,700	10,600		
85	10,700	10,600	10,400	
90	10,700	10,600	10,400	
95	10,700	10,600	10,300	
100	10,700	10,600	10,100	9,200
105	10,700	10,600	9,800	9,000
110	10,700	10,600	9,600	8,800
115	10,700	10,500	9,400	8,600
120	10,700	10,200	9,100	8,400
125	9,800	10,000	8,900	8,300
130	8,700	9,700	8,700	8,100
135	7,800	9,000	8,500	8,000
140	6,900	8,000	8,400	7,800
145	6,100	7,200	8,200	7,600
150	5,300	6,300	7,400	7,500
155	4,600	5,600	6,500	7,200
160	4,000	4,900	5,800	6,400
165	3,400	4,300	5,100	5,700
170	2,800	3,600	4,400	5,000
175	2,300	3,100	3,800	4,300
180		2,500	3,200	3,700
185			2,700	3,100
190			2,100	2,500
Min Angle	54.0	55.0	55.5	55.5
Max Rad.	178.0	185.0	191.0	195.0
Capacity	0	0	0	0

1041110



PORTLAND OFFICE: 503.283.3111
 SEATTLE OFFICE: 206.784.1054
WWW.NESSCAMPBELL.COM

Rated Lifting Capacities in Pounds

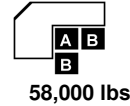
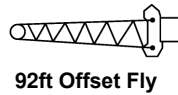
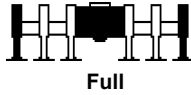

Radius (ft)	Boom Length (ft)											
	Fly Offset											
	44.3				73.5				103.8			
	2°	15°	30°	45°	2°	15°	30°	45°	2°	15°	30°	45°
20	19,800											
25	18,100				17,300							
30	16,700				17,300				15,200			
35	15,500	14,400			17,300				15,200			
40	14,400	13,400			16,300	14,600			15,200			
45	13,400	12,600	11,900		15,300	13,800			15,200	14,700		
50	12,600	11,800	11,200		14,400	13,100			15,200	14,000		
55	11,800	11,200	10,600		13,600	12,400	11,400		15,200	13,400		
60	11,100	10,500	10,000	9,700	12,900	11,800	10,900		14,400	12,800	11,500	
65	10,500	10,000	9,500	9,300	12,200	11,200	10,400	9,800	13,700	12,200	11,000	
70	9,900	9,500	9,100	8,800	11,600	10,700	10,000	9,400	13,100	11,700	10,600	9,800
75	9,400	9,000	8,700	8,400	11,000	10,200	9,500	9,100	12,500	11,300	10,200	9,500
80	8,900	8,600	8,300	8,100	10,500	9,800	9,200	8,700	12,000	10,800	9,900	9,200
85	8,400	8,100	7,800	7,700	10,000	9,400	8,800	8,400	11,500	10,400	9,500	8,900
90	7,900	7,700	7,400	7,300	9,600	9,000	8,500	8,200	11,000	10,000	9,200	8,700
95	7,400	7,200	7,100	7,000	9,200	8,700	8,200	7,900	10,600	9,700	8,900	8,400
100	7,000	6,800	6,700	6,600	8,800	8,300	7,800	7,600	10,200	9,300	8,600	8,200
105	6,500	6,400	6,300	6,300	8,400	7,900	7,500	7,300	9,800	9,000	8,400	8,000
110	6,100	6,000	6,000	6,000	8,000	7,600	7,200	7,000	9,400	8,700	8,100	7,700
115	5,800	5,700	5,700		7,600	7,200	6,900	6,800	9,100	8,400	7,800	7,500
120	5,400	5,400	5,400		7,200	6,900	6,600	6,500	8,800	8,100	7,600	7,300
125	5,100	5,100			6,800	6,500	6,300	6,300	8,400	7,800	7,300	7,100
130					6,500	6,200	6,100	6,100	8,100	7,500	7,100	6,900
135					6,100	6,000	5,800	5,900	7,700	7,200	6,800	6,700
140					5,800	5,700	5,600		7,400	6,900	6,600	6,400
145					5,600	5,500	5,400		7,000	6,700	6,400	6,300
150					5,300	5,200			6,700	6,400	6,200	6,100
155									6,400	6,200	6,000	5,900
160									6,200	5,900	5,800	5,800
165									5,900	5,700	5,600	
170									5,700	5,500	5,400	
175									5,500	5,300	5,300	
180									5,300	5,200		
Min Angle	0.0	0.0	0.0	0.0	14.0	17.0	26.5	26.0	15.5	17.5	25.0	22.5
Max Rad.	127.9	127.5	124.9	120.1	155.0	155.0	150.0	141.2	185.0	185.0	180.0	171.4
Capacity	3,100	3,100	3,400	3,900	0	0	0	0	0	0	0	0

1041120



PORTLAND OFFICE: 503.283.3111
 SEATTLE OFFICE: 206.784.1054
WWW.NESSCAMPBELL.COM

Rated Lifting Capacities in Pounds

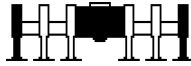

Full

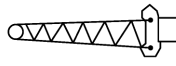

92ft Offset Fly



58,000 lbs



360°



Radius (ft)	Boom Length (ft)											
	Fly Offset											
	119.4				135.4				152.0			
	2°	15°	30°	45°	2°	15°	30°	45°	2°	15°	30°	45°
35	14,900				14,900							
40	14,900				14,900				14,100			
45	14,900				14,900				14,100			
50	14,900	14,500			14,900				14,100			
55	14,900	13,800			14,900	14,200			14,100			
60	14,900	13,300			14,900	13,700			14,100	14,000		
65	14,400	12,700	11,300		14,900	13,100			14,100	13,500		
70	13,800	12,200	10,900		14,500	12,600	11,200		14,100	13,000	11,400	
75	13,200	11,700	10,500	9,700	13,900	12,200	10,800		14,100	12,600	11,100	
80	12,600	11,300	10,200	9,400	13,300	11,700	10,500	9,600	13,900	12,100	10,700	
85	12,100	10,900	9,900	9,200	12,800	11,300	10,100	9,300	13,400	11,700	10,400	9,500
90	11,700	10,500	9,500	8,900	12,300	10,900	9,800	9,100	12,900	11,400	10,100	9,300
95	11,200	10,100	9,300	8,700	11,800	10,600	9,500	8,900	12,500	11,000	9,800	9,100
100	10,800	9,800	9,000	8,400	11,400	10,200	9,300	8,600	12,000	10,700	9,600	8,800
105	10,400	9,500	8,700	8,200	11,000	9,900	9,000	8,400	11,600	10,300	9,300	8,600
110	10,000	9,200	8,500	8,000	10,600	9,600	8,800	8,200	11,200	10,000	9,100	8,400
115	9,700	8,900	8,200	7,800	10,300	9,300	8,500	8,000	10,900	9,700	8,800	8,300
120	9,400	8,600	8,000	7,600	9,900	9,100	8,300	7,800	10,500	9,500	8,600	8,100
125	9,000	8,300	7,700	7,400	9,600	8,800	8,100	7,600	10,200	9,200	8,400	7,900
130	8,700	8,000	7,500	7,200	9,300	8,500	7,900	7,400	9,900	9,000	8,200	7,700
135	8,400	7,800	7,300	7,000	9,000	8,300	7,600	7,300	9,600	8,700	8,000	7,500
140	8,100	7,500	7,100	6,800	8,700	8,000	7,400	7,100	9,000	8,500	7,800	7,300
145	7,800	7,200	6,800	6,600	8,400	7,800	7,200	6,900	8,200	8,200	7,600	7,200
150	7,500	7,000	6,600	6,400	8,100	7,500	7,000	6,800	7,400	8,000	7,400	7,000
155	7,200	6,700	6,400	6,300	7,900	7,300	6,800	6,600	6,700	7,500	7,200	6,900
160	6,900	6,500	6,200	6,100	7,300	7,000	6,600	6,400	6,100	6,800	7,000	6,700
165	6,600	6,200	6,000	6,000	6,700	6,800	6,400	6,300	5,500	6,100	6,800	6,600
170	6,300	6,000	5,800	5,800	6,100	6,500	6,200	6,100	4,900	5,500	6,100	6,400
175	6,100	5,800	5,700		5,600	6,100	6,100	6,000	4,400	4,900	5,500	5,800
180	5,900	5,600	5,500		5,100	5,500	5,900	5,900	3,900	4,400	4,900	5,100
185	5,600	5,500	5,400		4,600	5,000	5,300	5,400	3,400	3,900	4,300	4,500
190	5,100	5,300	5,300		4,200	4,500	4,800		3,000	3,400	3,800	4,000
195	4,700	4,900			3,800	4,100	4,300		2,500	3,000	3,300	3,400
200					3,400	3,700	3,800		2,100	2,500	2,800	
205					3,000	3,200	3,300			2,100	2,400	
210					2,700	2,800						
Min Angle	16.0	18.5	25.0	19.5	16.5	18.5	24.5	16.5	36.0	36.5	36.5	36.0
Max Rad. Capacity	200.0	200.0	195.0	187.0	215.0	215.0	210.0	203.1	201.7	206.3	209.0	209.0
	0	0	0	0	0	0	0	0	0	0	0	0

1041120



PORTLAND OFFICE: 503.283.3111
 SEATTLE OFFICE: 206.784.1054
WWW.NESSCAMPBELL.COM

Rated Lifting Capacities in Pounds

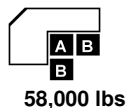
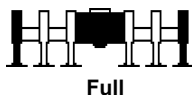

Radius (ft)	Boom Length (ft)			
	Fly Offset			
	168.5			
	2°	15°	30°	45°
45	12,200			
50	12,200			
55	12,200			
60	12,200	12,100		
65	12,200	12,100		
70	12,200	12,100		
75	12,200	12,100		
80	12,200	12,100	10,900	
85	12,200	12,100	10,600	
90	12,200	11,700	10,400	9,400
95	12,200	11,400	10,100	9,200
100	12,200	11,100	9,800	9,000
105	12,200	10,700	9,600	8,800
110	11,800	10,400	9,300	8,600
115	11,400	10,100	9,100	8,400
120	11,100	9,800	8,900	8,300
125	10,700	9,600	8,700	8,100
130	9,700	9,300	8,500	7,900
135	8,800	9,100	8,300	7,800
140	7,900	8,900	8,100	7,600
145	7,100	8,100	7,900	7,400
150	6,300	7,300	7,700	7,300
155	5,600	6,500	7,300	7,100
160	5,000	5,800	6,600	7,000
165	4,400	5,200	5,900	6,400
170	3,800	4,500	5,200	5,700
175	3,300	4,000	4,600	5,000
180	2,800	3,400	4,000	4,400
185	2,300	2,900	3,500	3,800
190		2,400	2,900	3,200
195			2,400	2,700
200				2,200
Min Angle	46.5	47.5	47.5	47.5
Max Rad.	188.8	195.0	200.0	202.0
Capacity	0	0	0	0

1041120



PORTLAND OFFICE: 503.283.3111
 SEATTLE OFFICE: 206.784.1054
WWW.NESSCAMPBELL.COM

Rated Lifting Capacities in Pounds

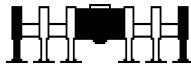

Full

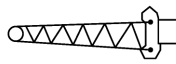

92ft Hydraulic Offset Fly



58,000 lbs



Radius (ft)	Boom Length (ft)											
	Fly Offset											
	44.3			73.5			103.8			134.9		
	2°-15°	15°-30°	30°-45°	2°-15°	15°-30°	30°-45°	2°-15°	15°-30°	30°-45°	2°-15°	15°-30°	30°-45°
20	19,800											
25	18,100			17,300								
30	15,500	15,500		17,300			15,200					
35	14,400	14,400		15,500	15,500		15,200			12,900		
40	13,400	13,400		14,600	14,600		15,200			12,900		
45	12,600	11,900	11,900	13,800	13,800		14,700	14,700		12,900		
50	11,800	11,200	11,200	13,100	11,900	11,900	14,000	14,000		12,800	12,800	
55	11,200	10,600	10,200	12,400	11,400	11,400	13,400	13,400		12,800	12,800	
60	10,500	10,000	9,700	11,800	10,900	10,200	12,800	11,500	11,500	12,800	12,800	
65	10,000	9,500	9,300	11,200	10,400	9,800	12,200	11,000	11,000	12,800	12,800	
70	9,500	9,100	8,800	10,700	10,000	9,400	11,700	10,600	9,800	12,600	11,200	11,200
75	9,000	8,700	8,400	10,200	9,500	9,100	11,300	10,200	9,500	12,200	10,800	10,800
80	8,600	8,300	8,100	9,800	9,200	8,700	10,800	9,900	9,200	11,700	10,500	9,600
85	8,100	7,800	7,700	9,400	8,800	8,400	10,400	9,500	8,900	11,300	10,100	9,300
90	7,700	7,400	7,300	9,000	8,500	8,200	10,000	9,200	8,700	10,900	9,800	9,100
95	7,200	7,100	7,000	8,700	8,200	7,900	9,700	8,900	8,400	10,600	9,500	8,900
100	6,800	6,700	6,600	8,300	7,800	7,600	9,300	8,600	8,200	10,200	9,300	8,600
105	6,400	6,300	6,300	7,900	7,500	7,300	9,000	8,400	8,000	9,900	9,000	8,400
110	6,000	6,000	6,000	7,600	7,200	7,000	8,700	8,100	7,700	9,600	8,800	8,200
115	5,700	5,700	5,700	7,200	6,900	6,800	8,400	7,800	7,500	9,300	8,500	8,000
120	5,400	5,400	5,400	6,900	6,600	6,500	8,100	7,600	7,300	9,000	8,300	7,800
125	5,100	5,100		6,500	6,300	6,300	7,800	7,300	7,100	8,800	8,100	7,600
130				6,200	6,100	6,100	7,500	7,100	6,900	8,500	7,900	7,400
135				6,000	5,800	5,800	7,200	6,800	6,700	8,300	7,600	7,300
140				5,700	5,600	5,600	6,900	6,600	6,400	8,000	7,400	7,100
145				5,500	5,400		6,700	6,400	6,300	7,700	7,200	6,900
150				5,200			6,400	6,200	6,100	7,500	7,000	6,700
155							6,200	6,000	5,900	7,200	6,800	6,600
160							5,900	5,800	5,800	7,000	6,600	6,400
165							5,700	5,600	5,600	6,800	6,400	6,300
170							5,500	5,400	5,400	6,500	6,200	6,100
175							5,300	5,300		6,000	6,000	6,000
180							5,200			5,500	5,900	5,900
185										5,000	5,400	5,700
190										4,600	4,900	5,100
195										4,100	4,400	4,600
200										3,800	4,000	4,000
205										3,400	3,600	
210										3,100		
Min Angle	0.0	0.0	0.0	14.0	26.5	26.0	15.5	25.0	22.5	16.5	25.0	19.5
Max Rad.	127.9	127.5	124.9	155.0	150.0	141.2	185.0	180.0	171.4	215.0	210.0	202.6
Capacity	3,100	3,100	3,400	0	0	0	0	0	0	0	0	0

1042100



PORTLAND OFFICE: 503.283.3111
 SEATTLE OFFICE: 206.784.1054
WWW.NESSCAMPBELL.COM

Rated Lifting Capacities in Pounds

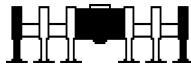

Full

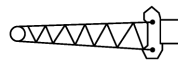

92ft Hydraulic Offset Fly



58,000 lbs



Radius (ft)	Boom Length (ft)								
	Fly Offset								
	167.1			183.6			200.1		
	2°-15°	15°-30°	30°-45°	2°-15°	15°-30°	30°-45°	2°-15°	15°-30°	30°-45°
45	10,400								
50	10,400			9,600					
55	10,300	10,300		9,600			8,200		
60	10,300	10,300		9,500	9,500		8,200		
65	10,300	10,300		9,500	9,500		8,100	8,100	
70	10,300	10,300		9,500	9,500		8,100	8,100	
75	10,300	10,200	10,200	9,500	9,500		8,100	8,100	
80	10,300	10,200	10,200	9,500	9,400	9,400	8,100	8,100	
85	10,300	10,200	9,600	9,500	9,400	9,400	8,100	8,000	8,000
90	10,300	10,200	9,400	9,500	9,400	9,200	8,100	8,000	8,000
95	10,300	10,100	9,200	9,500	9,400	9,200	8,100	8,000	7,800
100	10,300	9,800	9,000	9,500	9,400	9,100	8,100	8,000	7,800
105	10,300	9,500	8,800	9,500	9,400	9,000	8,100	8,000	7,800
110	10,300	9,300	8,600	9,500	9,400	8,800	8,100	8,000	7,800
115	10,100	9,100	8,400	9,500	9,300	8,600	8,100	8,000	7,800
120	9,800	8,900	8,300	9,500	9,100	8,400	8,100	8,000	7,800
125	9,600	8,700	8,100	9,500	8,900	8,300	8,100	8,000	7,800
130	9,300	8,500	7,900	9,500	8,700	8,100	8,100	8,000	7,800
135	9,100	8,300	7,700	8,900	8,500	8,000	8,000	8,000	7,800
140	8,800	8,100	7,600	8,000	8,300	7,800	7,100	8,000	7,800
145	8,300	7,900	7,400	7,200	8,200	7,600	6,300	7,400	7,800
150	7,500	7,700	7,200	6,500	7,400	7,500	5,500	6,600	7,600
155	6,800	7,500	7,100	5,800	6,600	7,300	4,800	5,800	6,800
160	6,100	6,900	7,000	5,100	5,900	6,800	4,200	5,100	6,000
165	5,500	6,200	6,800	4,500	5,300	6,100	3,600	4,500	5,300
170	5,000	5,600	6,200	3,900	4,700	5,400	3,000	3,900	4,700
175	4,400	5,000	5,600	3,400	4,100	4,800	2,500	3,300	4,000
180	3,900	4,500	5,000	2,900	3,600	4,200		2,700	3,500
185	3,500	4,000	4,500	2,400	3,100	3,700		2,200	2,900
190	3,000	3,500	4,000		2,600	3,100			2,400
195	2,600	3,100	3,500		2,100	2,600			
200	2,200	2,600	3,000			2,200			
205		2,200	2,600						
210			2,100						
Min Angle	42.0	42.5	43.5	51.0	51.5	52.0	57.0	57.5	58.0
Max Rad. Capacity	202.5	208.3	211.3	190.0	196.3	202.0	180.0	187.5	194.0
	0	0	0	0	0	0	0	0	0

1042100



PORTLAND OFFICE: 503.283.3111
 SEATTLE OFFICE: 206.784.1054
WWW.NESSCAMPBELL.COM

Rated Lifting Capacities in Pounds

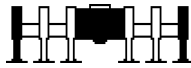

Full

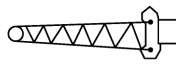

92ft Hydraulic Offset Fly



58,000 lbs



Radius (ft)	Boom Length (ft)											
	Fly Offset											
	44.3			58.9			89.1			120.3		
	2°-15°	15°-30°	30°-45°	2°-15°	15°-30°	30°-45°	2°-15°	15°-30°	30°-45°	2°-15°	15°-30°	30°-45°
20	19,800			19,700								
25	18,100			19,200			18,900					
30	15,500	15,500		16,000	16,000		18,900					
35	14,400	14,400		15,000	15,000		18,300			16,500		
40	13,400	13,400		14,100	14,100		15,100	15,100		16,500		
45	12,600	11,900	11,900	13,300	12,200	12,200	14,300	14,300		16,500		
50	11,800	11,200	11,200	12,500	11,600	11,600	13,600	13,600		14,500	14,500	
55	11,200	10,600	10,200	11,800	11,000	11,000	12,900	11,700	11,700	13,900	13,900	
60	10,500	10,000	9,700	11,200	10,500	10,000	12,300	11,200	11,200	13,300	11,700	11,700
65	10,000	9,500	9,300	10,600	10,000	9,600	11,800	10,700	10,000	12,700	11,300	11,300
70	9,500	9,100	8,800	10,100	9,600	9,200	11,300	10,300	9,700	12,200	10,900	10,000
75	9,000	8,700	8,400	9,600	9,100	8,800	10,800	9,900	9,300	11,800	10,500	9,700
80	8,600	8,300	8,100	9,200	8,700	8,400	10,400	9,600	9,000	11,300	10,200	9,400
85	8,100	7,800	7,700	8,800	8,400	8,100	9,900	9,200	8,700	10,900	9,900	9,200
90	7,700	7,400	7,300	8,400	8,000	7,800	9,600	8,900	8,400	10,500	9,600	8,900
95	7,200	7,100	7,000	8,000	7,700	7,500	9,200	8,600	8,200	10,200	9,300	8,700
100	6,800	6,700	6,600	7,600	7,300	7,200	8,900	8,300	7,900	9,800	9,000	8,400
105	6,400	6,300	6,300	7,200	7,000	6,900	8,500	8,000	7,700	9,500	8,700	8,200
110	6,000	6,000	6,000	6,800	6,600	6,600	8,200	7,700	7,400	9,200	8,500	8,000
115	5,700	5,700	5,700	6,500	6,300	6,300	7,900	7,400	7,200	8,900	8,300	7,800
120	5,400	5,400	5,400	6,200	6,000	6,000	7,600	7,200	7,000	8,600	8,000	7,600
125	5,100	5,100		5,800	5,800	5,800	7,200	6,900	6,700	8,400	7,700	7,400
130				5,600	5,500		6,900	6,600	6,500	8,100	7,500	7,200
135				5,300			6,600	6,400	6,300	7,800	7,300	7,000
140							6,300	6,100	6,100	7,500	7,100	6,800
145							6,100	5,900	5,900	7,300	6,800	6,600
150							5,800	5,700	5,700	7,000	6,600	6,500
155							5,600	5,500	5,500	6,700	6,400	6,300
160							5,400	5,400		6,500	6,200	6,100
165							5,200			6,300	6,000	6,000
170										6,100	5,900	5,800
175										5,900	5,700	5,700
180										5,400	5,500	5,500
185										5,000	5,300	5,400
190										4,500	4,800	
195										4,100		
Min Angle	0.0	0.0	0.0	14.5	28.5	9.5	15.0	26.0	18.5	17.0	25.5	17.0
Max Rad. Capacity	127.9	127.5	124.9	140.0	135.0	126.6	170.0	165.0	156.8	200.0	195.0	188.0
	3,100	3,100	3,400	0	0	0	0	0	0	0	0	0

1042110



PORTLAND OFFICE: 503.283.3111
 SEATTLE OFFICE: 206.784.1054
WWW.NESSCAMPBELL.COM

Rated Lifting Capacities in Pounds

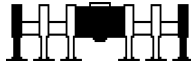

Full

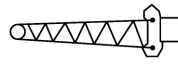

92ft Hydraulic Offset Fly



58,000 lbs



Radius (ft)	Boom Length (ft)								
	Fly Offset								
	152.4			169.0			185.5		
	2°-15°	15°-30°	30°-45°	2°-15°	15°-30°	30°-45°	2°-15°	15°-30°	30°-45°
40	13,500								
45	13,500								
50	13,500			12,500			10,700		
55	13,300	13,300		12,500			10,700		
60	13,300	13,300		12,400	12,400		10,700		
65	13,300	13,300		12,400	12,400		10,600	10,600	
70	13,000	11,400	11,400	12,400	12,400		10,600	10,600	
75	12,600	11,100	11,100	12,400	11,300	11,300	10,600	10,600	
80	12,200	10,700	9,800	12,400	10,900	10,900	10,600	10,400	10,400
85	11,800	10,400	9,500	12,100	10,700	10,700	10,600	10,400	10,400
90	11,400	10,100	9,300	11,800	10,400	9,400	10,600	10,400	10,400
95	11,000	9,800	9,100	11,400	10,100	9,200	10,600	10,300	9,400
100	10,700	9,600	8,800	11,100	9,800	9,000	10,600	10,100	9,200
105	10,300	9,300	8,600	10,700	9,600	8,800	10,600	9,800	9,000
110	10,000	9,100	8,400	10,400	9,300	8,600	10,600	9,600	8,800
115	9,800	8,800	8,300	10,100	9,100	8,500	10,500	9,400	8,600
120	9,500	8,600	8,100	9,900	8,900	8,300	10,200	9,100	8,400
125	9,200	8,400	7,900	9,600	8,700	8,100	9,800	8,900	8,300
130	9,000	8,200	7,700	9,300	8,500	7,900	8,700	8,700	8,100
135	8,700	8,000	7,500	8,700	8,300	7,800	7,800	8,500	8,000
140	8,500	7,800	7,400	7,900	8,100	7,600	6,900	8,000	7,800
145	8,100	7,600	7,200	7,000	7,900	7,400	6,100	7,200	7,600
150	7,400	7,400	7,000	6,300	7,200	7,300	5,300	6,300	7,400
155	6,700	7,200	6,900	5,600	6,500	7,100	4,600	5,600	6,500
160	6,000	6,700	6,700	4,900	5,800	6,600	4,000	4,900	5,800
165	5,400	6,100	6,600	4,300	5,100	5,800	3,400	4,300	5,100
170	4,800	5,500	6,100	3,800	4,500	5,200	2,800	3,600	4,400
175	4,300	4,900	5,400	3,200	3,900	4,600	2,300	3,100	3,800
180	3,800	4,400	4,800	2,700	3,400	4,000		2,500	3,200
185	3,300	3,800	4,300	2,300	2,900	3,400			2,700
190	2,900	3,400	3,800		2,400	2,900			2,100
195	2,500	2,900	3,300			2,400			
200	2,100	2,500	2,800						
205		2,100	2,300						
Min Angle	37.0	37.0	37.5	47.5	48.0	48.5	54.0	55.0	55.5
Max Rad. Capacity	201.3	206.3	208.0	188.0	194.0	199.0	178.0	185.0	191.0
	0	0	0	0	0	0	0	0	0

1042110



PORTLAND OFFICE: 503.283.3111
 SEATTLE OFFICE: 206.784.1054
WWW.NESSCAMPBELL.COM

Rated Lifting Capacities in Pounds

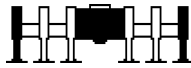

Full

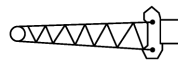

92ft Hydraulic Offset Fly



58,000 lbs



Radius (ft)	Boom Length (ft)											
	Fly Offset											
	44.3			73.5			103.8			119.4		
	2°-15°	15°-30°	30°-45°	2°-15°	15°-30°	30°-45°	2°-15°	15°-30°	30°-45°	2°-15°	15°-30°	30°-45°
20	19,800											
25	18,100			17,300								
30	15,500	15,500		17,300			15,200					
35	14,400	14,400		15,500	15,500		15,200			14,900		
40	13,400	13,400		14,600	14,600		15,200			14,900		
45	12,600	11,900	11,900	13,800	13,800		14,700	14,700		14,900		
50	11,800	11,200	11,200	13,100	11,900	11,900	14,000	14,000		14,500	14,500	
55	11,200	10,600	10,200	12,400	11,400	11,400	13,400	13,400		13,800	13,800	
60	10,500	10,000	9,700	11,800	10,900	10,200	12,800	11,500	11,500	13,300	13,300	
65	10,000	9,500	9,300	11,200	10,400	9,800	12,200	11,000	11,000	12,700	11,300	11,300
70	9,500	9,100	8,800	10,700	10,000	9,400	11,700	10,600	9,800	12,200	10,900	10,900
75	9,000	8,700	8,400	10,200	9,500	9,100	11,300	10,200	9,500	11,700	10,500	9,700
80	8,600	8,300	8,100	9,800	9,200	8,700	10,800	9,900	9,200	11,300	10,200	9,400
85	8,100	7,800	7,700	9,400	8,800	8,400	10,400	9,500	8,900	10,900	9,900	9,200
90	7,700	7,400	7,300	9,000	8,500	8,200	10,000	9,200	8,700	10,500	9,500	8,900
95	7,200	7,100	7,000	8,700	8,200	7,900	9,700	8,900	8,400	10,100	9,300	8,700
100	6,800	6,700	6,600	8,300	7,800	7,600	9,300	8,600	8,200	9,800	9,000	8,400
105	6,400	6,300	6,300	7,900	7,500	7,300	9,000	8,400	8,000	9,500	8,700	8,200
110	6,000	6,000	6,000	7,600	7,200	7,000	8,700	8,100	7,700	9,200	8,500	8,000
115	5,700	5,700	5,700	7,200	6,900	6,800	8,400	7,800	7,500	8,900	8,200	7,800
120	5,400	5,400	5,400	6,900	6,600	6,500	8,100	7,600	7,300	8,600	8,000	7,600
125	5,100	5,100		6,500	6,300	6,300	7,800	7,300	7,100	8,300	7,700	7,400
130				6,200	6,100	6,100	7,500	7,100	6,900	8,000	7,500	7,200
135				6,000	5,800	5,800	7,200	6,800	6,700	7,800	7,300	7,000
140				5,700	5,600	5,600	6,900	6,600	6,400	7,500	7,100	6,800
145				5,500	5,400		6,700	6,400	6,300	7,200	6,800	6,600
150				5,200			6,400	6,200	6,100	7,000	6,600	6,400
155							6,200	6,000	5,900	6,700	6,400	6,300
160							5,900	5,800	5,800	6,500	6,200	6,100
165							5,700	5,600	5,600	6,200	6,000	6,000
170							5,500	5,400	5,400	6,000	5,800	5,800
175							5,300	5,300		5,800	5,700	5,700
180							5,200			5,600	5,500	5,500
185										5,500	5,400	5,400
190										5,100	5,300	
195										4,700		
Min Angle	0.0	0.0	0.0	14.0	26.5	26.0	15.5	25.0	22.5	16.0	25.0	19.5
Max Rad. Capacity	127.9	127.5	124.9	155.0	150.0	141.2	185.0	180.0	171.4	200.0	195.0	187.0
	3,100	3,100	3,400	0	0	0	0	0	0	0	0	0

1042120



PORTLAND OFFICE: 503.283.3111
 SEATTLE OFFICE: 206.784.1054
WWW.NESSCAMPBELL.COM

Rated Lifting Capacities in Pounds

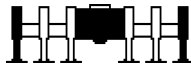

Full

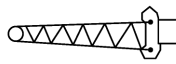

92ft Hydraulic Offset Fly



58,000 lbs



Radius (ft)	Boom Length (ft)								
	Fly Offset								
	135.4			152.0			168.5		
	2°-15°	15°-30°	30°-45°	2°-15°	15°-30°	30°-45°	2°-15°	15°-30°	30°-45°
35	14,900								
40	14,900			14,100					
45	14,900			14,100			12,200		
50	14,900			14,100			12,200		
55	14,200	14,200		14,000	14,000		12,200		
60	13,700	13,700		14,000	14,000		12,100	12,100	
65	13,100	11,500	11,500	13,500	13,500		12,100	12,100	
70	12,600	11,200	11,200	13,000	11,400	11,400	12,100	12,100	
75	12,200	10,800	9,900	12,600	11,100	11,100	12,100	11,300	11,300
80	11,700	10,500	9,600	12,100	10,700	9,800	12,100	10,900	10,900
85	11,300	10,100	9,300	11,700	10,400	9,500	12,100	10,600	9,700
90	10,900	9,800	9,100	11,400	10,100	9,300	11,700	10,400	9,400
95	10,600	9,500	8,900	11,000	9,800	9,100	11,400	10,100	9,200
100	10,200	9,300	8,600	10,700	9,600	8,800	11,100	9,800	9,000
105	9,900	9,000	8,400	10,300	9,300	8,600	10,700	9,600	8,800
110	9,600	8,800	8,200	10,000	9,100	8,400	10,400	9,300	8,600
115	9,300	8,500	8,000	9,700	8,800	8,300	10,100	9,100	8,400
120	9,100	8,300	7,800	9,500	8,600	8,100	9,800	8,900	8,300
125	8,800	8,100	7,600	9,200	8,400	7,900	9,600	8,700	8,100
130	8,500	7,900	7,400	9,000	8,200	7,700	9,300	8,500	7,900
135	8,300	7,600	7,300	8,700	8,000	7,500	8,800	8,300	7,800
140	8,000	7,400	7,100	8,500	7,800	7,300	7,900	8,100	7,600
145	7,800	7,200	6,900	8,200	7,600	7,200	7,100	7,900	7,400
150	7,500	7,000	6,800	7,400	7,400	7,000	6,300	7,300	7,300
155	7,300	6,800	6,600	6,700	7,200	6,900	5,600	6,500	7,100
160	7,000	6,600	6,400	6,100	6,800	6,700	5,000	5,800	6,600
165	6,700	6,400	6,300	5,500	6,100	6,600	4,400	5,200	5,900
170	6,100	6,200	6,100	4,900	5,500	6,100	3,800	4,500	5,200
175	5,600	6,100	6,000	4,400	4,900	5,500	3,300	4,000	4,600
180	5,100	5,500	5,900	3,900	4,400	4,900	2,800	3,400	4,000
185	4,600	5,000	5,300	3,400	3,900	4,300	2,300	2,900	3,500
190	4,200	4,500	4,800	3,000	3,400	3,800		2,400	2,900
195	3,800	4,100	4,200	2,500	3,000	3,300			2,400
200	3,400	3,700	3,700	2,100	2,500	2,800			
205	3,000	3,200			2,100	2,400			
210	2,700								
Min Angle	16.5	24.5	16.5	36.0	36.5	36.0	46.5	47.5	47.5
Max Rad. Capacity	215.0	210.0	203.1	201.7	206.3	209.0	188.8	195.0	200.0
	0	0	0	0	0	0	0	0	0

1042120



PORTLAND OFFICE: 503.283.3111
 SEATTLE OFFICE: 206.784.1054
WWW.NESSCAMPBELL.COM

Rated Lifting Capacities in Pounds

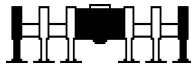

Full

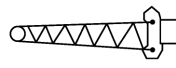

117ft Offset Fly



58,000 lbs



Radius (ft)	Boom Length (ft)											
	Fly Offset											
	44.3				73.5				103.8			
	2°	15°	30°	45°	2°	15°	30°	45°	2°	15°	30°	45°
25	15,800											
30	14,500				14,800							
35	13,300				14,800				13,100			
40	12,300	11,900			13,800				13,100			
45	11,400	11,000			12,900	12,000			13,100			
50	10,600	10,300	10,000		12,100	11,300			13,100			
55	9,900	9,600	9,400		11,300	10,700			12,600	11,500		
60	9,200	9,000	8,800		10,600	10,000	9,500		11,900	10,900		
65	8,600	8,400	8,300	8,200	10,000	9,500	9,000		11,300	10,400		
70	8,100	7,900	7,800	7,800	9,400	9,000	8,600	8,300	10,700	9,900	9,200	
75	7,600	7,500	7,400	7,300	8,900	8,500	8,200	7,900	10,100	9,400	8,800	
80	7,000	6,900	6,900	6,900	8,400	8,100	7,800	7,600	9,600	9,000	8,400	8,000
85	6,600	6,500	6,400	6,400	8,000	7,700	7,400	7,200	9,100	8,500	8,000	7,700
90	6,100	6,100	6,000	6,000	7,500	7,200	7,000	6,800	8,700	8,200	7,700	7,400
95	5,600	5,600	5,600	5,700	7,100	6,800	6,600	6,500	8,300	7,800	7,400	7,100
100	5,200	5,200	5,300	5,300	6,700	6,400	6,200	6,100	7,900	7,500	7,000	6,800
105	4,800	4,900	4,900	4,900	6,300	6,100	5,900	5,800	7,500	7,100	6,700	6,500
110	4,500	4,500	4,600	4,600	5,900	5,700	5,600	5,500	7,100	6,700	6,400	6,200
115	4,200	4,200	4,200	4,300	5,500	5,400	5,300	5,200	6,800	6,400	6,100	5,900
120	3,900	3,900	3,900	4,000	5,200	5,000	5,000	4,900	6,400	6,100	5,800	5,700
125	3,600	3,600	3,700	3,700	4,800	4,700	4,700	4,700	6,100	5,800	5,600	5,400
130	3,300	3,400	3,400	3,500	4,500	4,500	4,400	4,400	5,700	5,500	5,300	5,200
135	3,100	3,100	3,200		4,300	4,200	4,200	4,200	5,400	5,200	5,000	4,900
140	2,900	2,900	2,900		4,000	3,900	3,900	3,900	5,100	4,900	4,800	4,700
145	2,600	2,700			3,700	3,700	3,700	3,700	4,800	4,700	4,500	4,500
150	2,500	2,500			3,500	3,500	3,500	3,500	4,600	4,400	4,300	4,300
155					3,300	3,300	3,300	3,300	4,300	4,200	4,100	4,100
160					3,100	3,100	3,100		4,100	4,000	3,900	3,900
165					2,900	2,900	2,900		3,900	3,800	3,700	3,700
170					2,700	2,700	2,700		3,700	3,600	3,500	3,600
175					2,600	2,600			3,500	3,400	3,400	3,400
180									3,300	3,200	3,200	3,200
185									3,100	3,100	3,100	
190									3,000	2,900	2,900	
195									2,800	2,800	2,800	
200									2,700	2,600	2,700	
205									2,500	2,500		
Min Angle	0.0	0.0	0.0	0.0	13.5	16.0	24.0	29.5	15.0	17.0	23.5	27.5
Max Rad. Capacity	152.9	152.4	149.4	144.0	180.0	180.0	175.0	166.2	210.0	210.0	205.0	196.4
	2,400	2,400	2,500	2,700	0	0	0	0	0	0	0	0

1041130



PORTLAND OFFICE: 503.283.3111
 SEATTLE OFFICE: 206.784.1054
WWW.NESSCAMPBELL.COM

Rated Lifting Capacities in Pounds

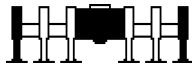

Full

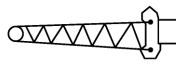

117ft Offset Fly



58,000 lbs



Radius (ft)	Boom Length (ft)											
	Fly Offset											
	134.9				167.1				183.6			
	2°	15°	30°	45°	2°	15°	30°	45°	2°	15°	30°	45°
45	11,000											
50	11,000				8,600							
55	11,000				8,600							
60	11,000				8,600				7,900			
65	11,000	10,900			8,600				7,900			
70	11,000	10,600			8,600	8,500			7,900			
75	11,000	10,200			8,600	8,500			7,900	7,800		
80	10,700	9,700	8,900		8,600	8,500			7,900	7,800		
85	10,200	9,300	8,600		8,600	8,500			7,900	7,800		
90	9,800	8,900	8,300	7,800	8,600	8,500	8,400		7,900	7,800		
95	9,300	8,600	8,000	7,500	8,600	8,500	8,400		7,900	7,800	7,700	
100	8,900	8,200	7,700	7,300	8,600	8,500	8,200	7,600	7,900	7,800	7,700	
105	8,600	7,900	7,400	7,000	8,600	8,500	7,900	7,400	7,900	7,800	7,700	7,500
110	8,200	7,600	7,100	6,700	8,600	8,300	7,600	7,200	7,900	7,800	7,700	7,400
115	7,900	7,300	6,800	6,500	8,600	8,000	7,400	6,900	7,900	7,800	7,600	7,200
120	7,500	7,000	6,500	6,200	8,500	7,800	7,100	6,700	7,900	7,800	7,400	6,900
125	7,200	6,700	6,300	6,000	8,200	7,500	6,900	6,500	7,900	7,800	7,200	6,700
130	6,900	6,400	6,000	5,800	7,900	7,200	6,600	6,300	7,900	7,600	6,900	6,500
135	6,600	6,100	5,800	5,600	7,600	6,900	6,400	6,100	7,900	7,300	6,700	6,300
140	6,300	5,900	5,500	5,400	7,300	6,700	6,200	5,900	7,700	7,000	6,500	6,100
145	6,000	5,600	5,300	5,100	7,000	6,400	6,000	5,700	7,100	6,800	6,200	5,900
150	5,700	5,300	5,100	4,900	6,700	6,200	5,700	5,500	6,300	6,500	6,000	5,700
155	5,400	5,100	4,900	4,700	6,400	5,900	5,500	5,300	5,600	6,300	5,800	5,600
160	5,100	4,900	4,700	4,500	6,000	5,700	5,300	5,100	5,000	5,900	5,600	5,400
165	4,900	4,600	4,500	4,400	5,300	5,500	5,100	4,900	4,300	5,200	5,400	5,200
170	4,600	4,400	4,300	4,200	4,800	5,200	4,900	4,800	3,800	4,600	5,200	5,000
175	4,400	4,200	4,100	4,000	4,200	4,900	4,700	4,600	3,200	4,000	4,800	4,900
180	4,200	4,000	3,900	3,900	3,700	4,400	4,600	4,400	2,700	3,500	4,200	4,700
185	4,000	3,900	3,800	3,700	3,200	3,900	4,400	4,300	2,200	3,000	3,600	4,100
190	3,800	3,700	3,600	3,600	2,800	3,400	3,900	4,100		2,500	3,100	3,500
195	3,700	3,500	3,500	3,500	2,400	2,900	3,400	3,800			2,600	3,000
200	3,500	3,400	3,300	3,300		2,500	3,000	3,200			2,100	2,500
205	3,100	3,200	3,200	3,200		2,100	2,500	2,800				
210	2,800	3,100	3,100				2,100	2,300				
215	2,400	2,700	2,900									
220	2,100	2,400	2,500									
225			2,100									
Min Angle	32.0	32.5	32.0	31.5	51.0	51.5	52.0	52.0	57.0	58.0	58.5	58.5
Max Rad. Capacity	221.7	225.0	226.7	225.0	200.0	206.3	211.3	213.8	187.5	195.0	201.3	205.0
	0	0	0	0	0	0	0	0	0	0	0	0

1041130



PORTLAND OFFICE: 503.283.3111
 SEATTLE OFFICE: 206.784.1054
WWW.NESSCAMPBELL.COM

Rated Lifting Capacities in Pounds

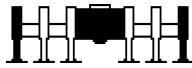

Full

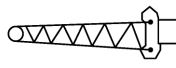

117ft Offset Fly



58,000 lbs



Radius (ft)	Boom Length (ft)			
	Fly Offset			
	200.1			
	2°	15°	30°	45°
60	6,700			
65	6,700			
70	6,700			
75	6,700			
80	6,700	6,600		
85	6,700	6,600		
90	6,700	6,600		
95	6,700	6,600	6,400	
100	6,700	6,600	6,400	
105	6,700	6,600	6,400	
110	6,700	6,600	6,400	6,300
115	6,700	6,600	6,400	6,300
120	6,700	6,600	6,400	6,300
125	6,700	6,600	6,400	6,300
130	6,700	6,600	6,400	6,300
135	6,700	6,600	6,400	6,300
140	6,700	6,600	6,400	6,300
145	6,200	6,600	6,400	6,100
150	5,400	6,500	6,300	5,900
155	4,700	5,700	6,100	5,800
160	4,100	5,000	5,900	5,600
165	3,400	4,400	5,300	5,400
170	2,900	3,800	4,600	5,300
175	2,300	3,200	4,000	4,600
180		2,600	3,400	4,000
185		2,100	2,900	3,400
190			2,400	2,800
195				2,300
Min Angle	62.5	63.0	63.5	63.5
Max Rad.	178.0	186.0	194.0	198.0
Capacity	0	0	0	0

1041130



PORTLAND OFFICE: 503.283.3111
 SEATTLE OFFICE: 206.784.1054
WWW.NESSCAMPBELL.COM

Rated Lifting Capacities in Pounds

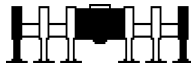

Full

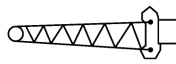

117ft Offset Fly



58,000 lbs



Radius (ft)	Boom Length (ft)											
	Fly Offset											
	44.3				58.9				89.1			
	2°	15°	30°	45°	2°	15°	30°	45°	2°	15°	30°	45°
25	15,800				16,400							
30	14,500				15,300							
35	13,300				14,100				15,600			
40	12,300	11,900			13,100	12,400			14,500			
45	11,400	11,000			12,200	11,600			13,600			
50	10,600	10,300	10,000		11,400	10,800			12,800	11,800		
55	9,900	9,600	9,400		10,600	10,200	9,800		12,000	11,100		
60	9,200	9,000	8,800		10,000	9,600	9,200		11,300	10,500		
65	8,600	8,400	8,300	8,200	9,400	9,000	8,700	8,500	10,700	10,000	9,400	
70	8,100	7,900	7,800	7,800	8,800	8,500	8,200	8,100	10,100	9,500	8,900	
75	7,600	7,500	7,400	7,300	8,300	8,000	7,800	7,700	9,600	9,000	8,500	8,200
80	7,000	6,900	6,900	6,900	7,800	7,600	7,400	7,300	9,100	8,500	8,100	7,800
85	6,600	6,500	6,400	6,400	7,300	7,100	6,900	6,900	8,600	8,100	7,700	7,500
90	6,100	6,100	6,000	6,000	6,800	6,700	6,500	6,500	8,200	7,800	7,400	7,200
95	5,600	5,600	5,600	5,700	6,400	6,300	6,200	6,100	7,800	7,400	7,000	6,800
100	5,200	5,200	5,300	5,300	6,000	5,900	5,800	5,800	7,300	7,000	6,700	6,500
105	4,800	4,900	4,900	4,900	5,600	5,500	5,400	5,400	6,900	6,600	6,300	6,200
110	4,500	4,500	4,600	4,600	5,200	5,100	5,100	5,100	6,600	6,300	6,000	5,900
115	4,200	4,200	4,200	4,300	4,800	4,800	4,800	4,800	6,200	6,000	5,700	5,600
120	3,900	3,900	3,900	4,000	4,500	4,500	4,500	4,500	5,800	5,600	5,400	5,300
125	3,600	3,600	3,700	3,700	4,200	4,200	4,200	4,200	5,500	5,300	5,200	5,100
130	3,300	3,400	3,400	3,500	3,900	3,900	3,900	4,000	5,200	5,000	4,900	4,800
135	3,100	3,100	3,200		3,700	3,700	3,700	3,700	4,900	4,700	4,600	4,600
140	2,900	2,900	2,900		3,400	3,400	3,500	3,500	4,600	4,500	4,400	4,400
145	2,600	2,700			3,200	3,200	3,200		4,300	4,200	4,200	4,100
150	2,500	2,500			3,000	3,000	3,000		4,100	4,000	3,900	3,900
155					2,800	2,800	2,800		3,800	3,800	3,700	3,700
160					2,600	2,600			3,600	3,600	3,500	3,500
165									3,400	3,400	3,400	3,400
170									3,200	3,200	3,200	
175									3,000	3,000	3,000	
180									2,900	2,900	2,900	
185									2,700	2,700	2,700	
190									2,600	2,600		
Min Angle	0.0	0.0	0.0	0.0	14.0	17.0	25.5	30.0	14.5	17.0	24.0	27.0
Max Rad. Capacity	152.9	152.4	149.4	144.0	165.0	165.0	160.0	151.6	195.0	195.0	190.0	181.8
	2,400	2,400	2,500	2,700	0	0	0	0	0	0	0	0

1041140



PORTLAND OFFICE: 503.283.3111
 SEATTLE OFFICE: 206.784.1054
WWW.NESSCAMPBELL.COM

Rated Lifting Capacities in Pounds

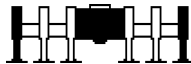

Full

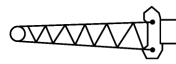

117ft Offset Fly



58,000 lbs



Radius (ft)	Boom Length (ft)											
	Fly Offset											
	120.3				152.4				169.0			
	2°	15°	30°	45°	2°	15°	30°	45°	2°	15°	30°	45°
40	14,400											
45	14,400											
50	14,000				11,500							
55	13,200				11,500				10,600			
60	12,500	11,300			11,500				10,600			
65	11,900	10,800			11,500	11,400			10,600			
70	11,300	10,300	9,500		11,500	11,000			10,600			
75	10,700	9,800	9,100		11,500	10,600			10,600	10,500		
80	10,200	9,400	8,700	8,200	11,300	10,100	9,200		10,600	10,500		
85	9,700	9,000	8,300	7,900	10,800	9,700	8,900		10,600	10,100		
90	9,300	8,600	8,000	7,600	10,300	9,300	8,500	8,000	10,600	9,700	8,800	
95	8,900	8,200	7,700	7,400	9,900	9,000	8,200	7,700	10,400	9,300	8,500	
100	8,500	7,900	7,400	7,100	9,500	8,600	8,000	7,500	9,900	9,000	8,200	7,700
105	8,100	7,600	7,100	6,800	9,100	8,300	7,700	7,300	9,600	8,700	7,900	7,400
110	7,800	7,200	6,800	6,500	8,700	8,000	7,400	7,000	9,200	8,400	7,700	7,200
115	7,400	6,900	6,500	6,200	8,400	7,700	7,100	6,700	8,900	8,100	7,400	7,000
120	7,000	6,600	6,200	6,000	8,100	7,400	6,900	6,500	8,500	7,800	7,200	6,700
125	6,700	6,300	6,000	5,800	7,800	7,100	6,600	6,300	8,200	7,500	6,900	6,500
130	6,400	6,000	5,700	5,500	7,400	6,800	6,400	6,100	7,900	7,200	6,700	6,300
135	6,100	5,700	5,400	5,300	7,100	6,600	6,100	5,900	7,600	7,000	6,400	6,100
140	5,700	5,400	5,200	5,100	6,800	6,300	5,900	5,700	7,300	6,700	6,200	5,900
145	5,400	5,200	5,000	4,800	6,500	6,100	5,700	5,500	7,000	6,400	6,000	5,700
150	5,200	4,900	4,700	4,600	6,300	5,800	5,500	5,300	6,200	6,200	5,800	5,500
155	4,900	4,700	4,500	4,400	6,000	5,600	5,200	5,100	5,500	6,000	5,600	5,300
160	4,700	4,500	4,300	4,300	5,700	5,300	5,000	4,900	4,900	5,700	5,400	5,100
165	4,400	4,200	4,100	4,100	5,300	5,100	4,800	4,700	4,300	5,100	5,200	5,000
170	4,200	4,000	3,900	3,900	4,700	4,900	4,600	4,500	3,700	4,500	5,000	4,800
175	4,000	3,900	3,800	3,700	4,200	4,700	4,500	4,400	3,100	3,900	4,600	4,600
180	3,800	3,700	3,600	3,600	3,700	4,300	4,300	4,200	2,600	3,400	4,000	4,500
185	3,600	3,500	3,400	3,400	3,200	3,800	4,100	4,000	2,200	2,800	3,500	3,900
190	3,400	3,300	3,300	3,300	2,800	3,300	3,800	3,900		2,400	3,000	3,300
195	3,300	3,200	3,200	3,200	2,300	2,900	3,300	3,600			2,500	2,800
200	3,100	3,000	3,000			2,400	2,900	3,100				2,300
205	2,900	2,900	2,900				2,400	2,600				
210	2,800	2,800	2,800					2,100				
215	2,500	2,600	2,700									
220	2,200	2,300										
Min Angle	18.5	19.0	25.0	24.5	46.5	47.0	47.0	47.5	54.0	54.5	55.0	55.0
Max Rad. Capacity	223.3	225.0	220.0	213.0	198.8	205.0	210.0	211.3	187.0	194.0	200.0	203.0
	0	0	0	0	0	0	0	0	0	0	0	0

1041140



PORTLAND OFFICE: 503.283.3111
 SEATTLE OFFICE: 206.784.1054
WWW.NESSCAMPBELL.COM

Rated Lifting Capacities in Pounds

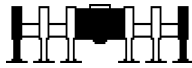

Full

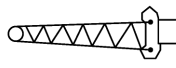

117ft Offset Fly



58,000 lbs



Radius (ft)	Boom Length (ft)			
	Fly Offset			
	185.5			
	2°	15°	30°	45°
60	9,000			
65	9,000			
70	9,000			
75	9,000			
80	9,000	9,000		
85	9,000	9,000		
90	9,000	9,000		
95	9,000	9,000	8,700	
100	9,000	9,000	8,400	
105	9,000	9,000	8,200	7,600
110	9,000	8,700	7,900	7,400
115	9,000	8,400	7,700	7,200
120	9,000	8,100	7,400	6,900
125	8,600	7,900	7,200	6,700
130	8,300	7,600	6,900	6,500
135	7,700	7,300	6,700	6,300
140	6,900	7,100	6,500	6,100
145	6,000	6,800	6,300	5,900
150	5,300	6,400	6,100	5,800
155	4,600	5,600	5,900	5,600
160	3,900	4,900	5,700	5,400
165	3,300	4,200	5,100	5,200
170	2,700	3,600	4,500	5,100
175	2,200	3,000	3,900	4,400
180		2,500	3,300	3,800
185			2,700	3,200
190			2,200	2,700
195				2,100
Min Angle	59.5	60.0	60.5	60.5
Max Rad.	177.0	185.0	192.0	196.0
Capacity	0	0	0	0

1041140



PORTLAND OFFICE: 503.283.3111
 SEATTLE OFFICE: 206.784.1054
WWW.NESSCAMPBELL.COM

Rated Lifting Capacities in Pounds

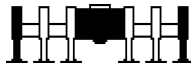

Full

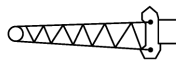

117ft Offset Fly



58,000 lbs



Radius (ft)	Boom Length (ft)											
	Fly Offset											
	44.3				73.5				103.8			
	2°	15°	30°	45°	2°	15°	30°	45°	2°	15°	30°	45°
25	15,800											
30	14,500				14,800							
35	13,300				14,800				13,100			
40	12,300	11,900			13,800				13,100			
45	11,400	11,000			12,900	12,000			13,100			
50	10,600	10,300	10,000		12,100	11,300			13,100			
55	9,900	9,600	9,400		11,300	10,700			12,600	11,500		
60	9,200	9,000	8,800		10,600	10,000	9,500		11,900	10,900		
65	8,600	8,400	8,300	8,200	10,000	9,500	9,000		11,300	10,400		
70	8,100	7,900	7,800	7,800	9,400	9,000	8,600	8,300	10,700	9,900	9,200	
75	7,600	7,500	7,400	7,300	8,900	8,500	8,200	7,900	10,100	9,400	8,800	
80	7,000	6,900	6,900	6,900	8,400	8,100	7,800	7,600	9,600	9,000	8,400	8,000
85	6,600	6,500	6,400	6,400	8,000	7,700	7,400	7,200	9,100	8,500	8,000	7,700
90	6,100	6,100	6,000	6,000	7,500	7,200	7,000	6,800	8,700	8,200	7,700	7,400
95	5,600	5,600	5,600	5,700	7,100	6,800	6,600	6,500	8,300	7,800	7,400	7,100
100	5,200	5,200	5,300	5,300	6,700	6,400	6,200	6,100	7,900	7,500	7,000	6,800
105	4,800	4,900	4,900	4,900	6,300	6,100	5,900	5,800	7,500	7,100	6,700	6,500
110	4,500	4,500	4,600	4,600	5,900	5,700	5,600	5,500	7,100	6,700	6,400	6,200
115	4,200	4,200	4,200	4,300	5,500	5,400	5,300	5,200	6,800	6,400	6,100	5,900
120	3,900	3,900	3,900	4,000	5,200	5,000	5,000	4,900	6,400	6,100	5,800	5,700
125	3,600	3,600	3,700	3,700	4,800	4,700	4,700	4,700	6,100	5,800	5,600	5,400
130	3,300	3,400	3,400	3,500	4,500	4,500	4,400	4,400	5,700	5,500	5,300	5,200
135	3,100	3,100	3,200		4,300	4,200	4,200	4,200	5,400	5,200	5,000	4,900
140	2,900	2,900	2,900		4,000	3,900	3,900	3,900	5,100	4,900	4,800	4,700
145	2,600	2,700			3,700	3,700	3,700	3,700	4,800	4,700	4,500	4,500
150	2,500	2,500			3,500	3,500	3,500	3,500	4,600	4,400	4,300	4,300
155					3,300	3,300	3,300	3,300	4,300	4,200	4,100	4,100
160					3,100	3,100	3,100		4,100	4,000	3,900	3,900
165					2,900	2,900	2,900		3,900	3,800	3,700	3,700
170					2,700	2,700	2,700		3,700	3,600	3,500	3,600
175					2,600	2,600			3,500	3,400	3,400	3,400
180									3,300	3,200	3,200	3,200
185									3,100	3,100	3,100	
190									3,000	2,900	2,900	
195									2,800	2,800	2,800	
200									2,700	2,600	2,700	
205									2,500	2,500		
Min Angle	0.0	0.0	0.0	0.0	13.5	16.0	24.0	29.5	15.0	17.0	23.5	27.5
Max Rad. Capacity	152.9	152.4	149.4	144.0	180.0	180.0	175.0	166.2	210.0	210.0	205.0	196.4
	2,400	2,400	2,500	2,700	0	0	0	0	0	0	0	0

1041150



PORTLAND OFFICE: 503.283.3111
 SEATTLE OFFICE: 206.784.1054
WWW.NESSCAMPBELL.COM

Rated Lifting Capacities in Pounds

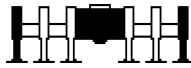

Full

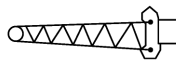

117ft Offset Fly



58,000 lbs



Radius (ft)	Boom Length (ft)											
	Fly Offset											
	119.4				135.4				152.0			
	2°	15°	30°	45°	2°	15°	30°	45°	2°	15°	30°	45°
40	12,800											
45	12,800				12,700							
50	12,800				12,700				11,900			
55	12,800				12,700				11,900			
60	12,500	11,300			12,700	11,700			11,900			
65	11,800	10,800			12,400	11,100			11,900	11,500		
70	11,200	10,300			11,800	10,700			11,900	11,000		
75	10,700	9,800	9,100		11,200	10,200	9,300		11,800	10,500		
80	10,200	9,400	8,700		10,700	9,800	8,900		11,200	10,100	9,200	
85	9,700	9,000	8,300	7,900	10,200	9,300	8,600	8,100	10,800	9,700	8,900	
90	9,300	8,600	8,000	7,600	9,800	9,000	8,300	7,800	10,300	9,300	8,500	8,000
95	8,800	8,200	7,700	7,300	9,400	8,600	8,000	7,500	9,900	9,000	8,200	7,700
100	8,400	7,900	7,400	7,000	9,000	8,300	7,700	7,300	9,500	8,600	8,000	7,500
105	8,100	7,600	7,100	6,800	8,600	7,900	7,400	7,000	9,100	8,300	7,700	7,300
110	7,700	7,200	6,800	6,500	8,200	7,600	7,100	6,700	8,700	8,000	7,400	7,000
115	7,400	6,900	6,500	6,200	7,900	7,300	6,800	6,500	8,400	7,700	7,100	6,700
120	7,000	6,600	6,200	6,000	7,600	7,000	6,500	6,200	8,100	7,400	6,900	6,500
125	6,700	6,300	5,900	5,700	7,200	6,700	6,300	6,000	7,800	7,100	6,600	6,300
130	6,300	6,000	5,700	5,500	6,900	6,400	6,000	5,800	7,400	6,800	6,400	6,100
135	6,000	5,700	5,400	5,300	6,600	6,100	5,800	5,600	7,100	6,600	6,100	5,800
140	5,700	5,400	5,200	5,000	6,300	5,900	5,600	5,400	6,800	6,300	5,900	5,600
145	5,400	5,100	4,900	4,800	6,000	5,600	5,300	5,100	6,500	6,000	5,700	5,400
150	5,100	4,900	4,700	4,600	5,700	5,400	5,100	4,900	6,200	5,800	5,400	5,200
155	4,900	4,700	4,500	4,400	5,400	5,100	4,900	4,700	6,000	5,500	5,200	5,000
160	4,600	4,400	4,300	4,200	5,100	4,900	4,700	4,600	5,700	5,300	5,000	4,900
165	4,400	4,200	4,100	4,100	4,900	4,700	4,500	4,400	5,400	5,100	4,800	4,700
170	4,200	4,000	3,900	3,900	4,700	4,400	4,300	4,200	4,800	4,900	4,600	4,500
175	4,000	3,800	3,700	3,700	4,400	4,200	4,100	4,000	4,200	4,700	4,400	4,300
180	3,800	3,700	3,600	3,600	4,200	4,100	3,900	3,900	3,700	4,400	4,300	4,200
185	3,600	3,500	3,400	3,400	4,000	3,900	3,800	3,700	3,300	3,800	4,100	4,000
190	3,400	3,300	3,300	3,300	3,800	3,700	3,600	3,600	2,800	3,400	3,900	3,900
195	3,200	3,200	3,100	3,200	3,600	3,500	3,500	3,500	2,400	2,900	3,400	3,600
200	3,100	3,000	3,000		3,200	3,400	3,300	3,300		2,500	2,900	3,100
205	2,900	2,900	2,900		2,800	3,200	3,200	3,200		2,100	2,500	2,600
210	2,800	2,700	2,700		2,400	2,800	3,000					2,200
215	2,600	2,600	2,600		2,100	2,400	2,600					
220	2,500	2,500					2,200					
Min Angle	16.5	18.5	24.0	26.0	33.5	34.5	34.0	34.0	45.5	46.0	47.0	46.5
Max Rad. Capacity	225.0	225.0	220.0	212.0	216.7	220.0	222.5	221.3	200.0	206.3	210.0	212.0
	0	0	0	0	0	0	0	0	0	0	0	0

1041150



PORTLAND OFFICE: 503.283.3111
 SEATTLE OFFICE: 206.784.1054
WWW.NESSCAMPBELL.COM

Rated Lifting Capacities in Pounds

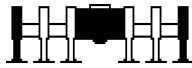

Full

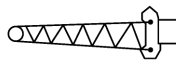

117ft Offset Fly



58,000 lbs



Radius (ft)	Boom Length (ft)			
	Fly Offset			
	168.5			
	2°	15°	30°	45°
50	10,200			
55	10,200			
60	10,200			
65	10,200			
70	10,200	10,100		
75	10,200	10,100		
80	10,200	10,100		
85	10,200	10,100	9,100	
90	10,200	9,700	8,800	
95	10,200	9,300	8,500	7,900
100	9,900	9,000	8,200	7,700
105	9,500	8,700	7,900	7,400
110	9,200	8,300	7,700	7,200
115	8,800	8,100	7,400	7,000
120	8,500	7,800	7,200	6,700
125	8,200	7,500	6,900	6,500
130	7,900	7,200	6,700	6,300
135	7,600	7,000	6,400	6,100
140	7,300	6,700	6,200	5,900
145	7,000	6,400	6,000	5,700
150	6,300	6,200	5,800	5,500
155	5,600	6,000	5,600	5,300
160	4,900	5,700	5,400	5,100
165	4,300	5,100	5,200	5,000
170	3,700	4,500	5,000	4,800
175	3,200	3,900	4,700	4,600
180	2,700	3,400	4,100	4,500
185	2,200	2,900	3,500	3,900
190		2,400	3,000	3,400
195			2,500	2,800
200				2,300
Min Angle	53.0	54.5	55.0	54.5
Max Rad.	187.5	194.0	200.0	203.8
Capacity	0	0	0	0

1041150



PORTLAND OFFICE: 503.283.3111
 SEATTLE OFFICE: 206.784.1054
WWW.NESSCAMPBELL.COM

Rated Lifting Capacities in Pounds

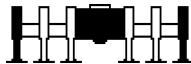

Full

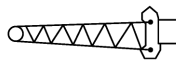

117ft Hydraulic Offset Fly



58,000 lbs



Radius (ft)	Boom Length (ft)											
	Fly Offset											
	44.3			73.5			103.8			134.9		
	2°-15°	15°-30°	30°-45°	2°-15°	15°-30°	30°-45°	2°-15°	15°-30°	30°-45°	2°-15°	15°-30°	30°-45°
25	15,800											
30	14,500			14,800								
35	12,800	12,800		14,800			13,100					
40	11,900	11,900		12,900	12,900		13,100					
45	11,000	11,000		12,000	12,000		13,100			11,000		
50	10,300	10,000	10,000	11,300	11,300		12,200	12,200		11,000		
55	9,600	9,400	9,400	10,700	10,100	10,100	11,500	11,500		11,000		
60	9,000	8,800	8,700	10,000	9,500	9,500	10,900	10,900		10,900	10,900	
65	8,400	8,300	8,200	9,500	9,000	8,700	10,400	9,600	9,600	10,900	10,900	
70	7,900	7,800	7,800	9,000	8,600	8,300	9,900	9,200	9,200	10,600	10,600	
75	7,500	7,400	7,300	8,500	8,200	7,900	9,400	8,800	8,400	10,200	9,300	9,300
80	6,900	6,900	6,900	8,100	7,800	7,600	9,000	8,400	8,000	9,700	8,900	8,900
85	6,500	6,400	6,400	7,700	7,400	7,200	8,500	8,000	7,700	9,300	8,600	8,100
90	6,100	6,000	6,000	7,200	7,000	6,800	8,200	7,700	7,400	8,900	8,300	7,800
95	5,600	5,600	5,600	6,800	6,600	6,500	7,800	7,400	7,100	8,600	8,000	7,500
100	5,200	5,200	5,300	6,400	6,200	6,100	7,500	7,000	6,800	8,200	7,700	7,300
105	4,800	4,900	4,900	6,100	5,900	5,800	7,100	6,700	6,500	7,900	7,400	7,000
110	4,500	4,500	4,600	5,700	5,600	5,500	6,700	6,400	6,200	7,600	7,100	6,700
115	4,200	4,200	4,200	5,400	5,300	5,200	6,400	6,100	5,900	7,300	6,800	6,500
120	3,900	3,900	3,900	5,000	5,000	4,900	6,100	5,800	5,700	7,000	6,500	6,200
125	3,600	3,600	3,700	4,700	4,700	4,700	5,800	5,600	5,400	6,700	6,300	6,000
130	3,300	3,400	3,400	4,500	4,400	4,400	5,500	5,300	5,200	6,400	6,000	5,800
135	3,100	3,100	3,200	4,200	4,200	4,200	5,200	5,000	4,900	6,100	5,800	5,600
140	2,900	2,900	2,900	3,900	3,900	3,900	4,900	4,800	4,700	5,900	5,500	5,400
145	2,600	2,700		3,700	3,700	3,700	4,700	4,500	4,500	5,600	5,300	5,100
150	2,500	2,500		3,500	3,500	3,500	4,400	4,300	4,300	5,300	5,100	4,900
155				3,300	3,300	3,300	4,200	4,100	4,100	5,100	4,900	4,700
160				3,100	3,100	3,100	4,000	3,900	3,900	4,900	4,700	4,500
165				2,900	2,900	2,900	3,800	3,700	3,700	4,600	4,500	4,400
170				2,700	2,700		3,600	3,500	3,500	4,400	4,300	4,200
175				2,600			3,400	3,400	3,400	4,200	4,100	4,000
180							3,200	3,200	3,200	4,000	3,900	3,900
185							3,100	3,100	3,100	3,900	3,800	3,700
190							2,900	2,900	2,900	3,700	3,600	3,600
195							2,800	2,800	2,800	3,500	3,500	3,500
200							2,600	2,600		3,400	3,300	3,300
205							2,500			3,100	3,200	3,200
210										2,800	3,100	3,100
215										2,400	2,700	2,900
220										2,100	2,400	2,400
Min Angle	0.0	0.0	0.0	13.5	24.0	29.5	15.0	23.5	27.5	32.0	32.5	31.5
Max Rad.	152.9	152.4	149.4	180.0	175.0	166.2	210.0	205.0	196.4	221.7	225.0	225.0
Capacity	2,400	2,400	2,500	0	0	0	0	0	0	0	0	0

1042130



PORTLAND OFFICE: 503.283.3111
 SEATTLE OFFICE: 206.784.1054
WWW.NESSCAMPBELL.COM

Rated Lifting Capacities in Pounds

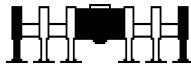

Full

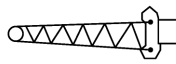

117ft Hydraulic Offset Fly



58,000 lbs



Radius (ft)	Boom Length (ft)								
	Fly Offset								
	167.1			183.6			200.1		
	2°-15°	15°-30°	30°-45°	2°-15°	15°-30°	30°-45°	2°-15°	15°-30°	30°-45°
50	8,600								
55	8,600								
60	8,600			7,900			6,700		
65	8,500	8,500		7,900			6,700		
70	8,500	8,500		7,800	7,800		6,600	6,600	
75	8,500	8,500		7,800	7,800		6,600	6,600	
80	8,500	8,500		7,800	7,800		6,600	6,600	
85	8,500	8,400	8,400	7,800	7,600	7,600	6,600	6,600	
90	8,500	8,400	8,400	7,800	7,600	7,600	6,600	6,600	
95	8,500	8,400	7,900	7,800	7,600	7,600	6,600	6,400	6,400
100	8,500	8,200	7,600	7,800	7,600	7,400	6,600	6,400	6,400
105	8,500	7,900	7,400	7,800	7,600	7,400	6,600	6,400	6,200
110	8,300	7,600	7,200	7,800	7,600	7,400	6,600	6,400	6,200
115	8,000	7,400	6,900	7,800	7,600	7,200	6,600	6,400	6,200
120	7,800	7,100	6,700	7,800	7,400	6,900	6,600	6,400	6,200
125	7,500	6,900	6,500	7,800	7,200	6,700	6,600	6,400	6,200
130	7,200	6,600	6,300	7,600	6,900	6,500	6,600	6,400	6,200
135	6,900	6,400	6,100	7,300	6,700	6,300	6,600	6,400	6,200
140	6,700	6,200	5,900	7,000	6,500	6,100	6,600	6,400	6,200
145	6,400	6,000	5,700	6,800	6,200	5,900	6,200	6,400	6,100
150	6,200	5,700	5,500	6,300	6,000	5,700	5,400	6,300	5,900
155	5,900	5,500	5,300	5,600	5,800	5,600	4,700	5,700	5,800
160	5,700	5,300	5,100	5,000	5,600	5,400	4,100	5,000	5,600
165	5,300	5,100	4,900	4,300	5,200	5,200	3,400	4,400	5,300
170	4,800	4,900	4,800	3,800	4,600	5,000	2,900	3,800	4,600
175	4,200	4,700	4,600	3,200	4,000	4,800	2,300	3,200	4,000
180	3,700	4,400	4,400	2,700	3,500	4,200		2,600	3,400
185	3,200	3,900	4,300	2,200	3,000	3,600		2,100	2,900
190	2,800	3,400	3,900		2,500	3,100			2,400
195	2,400	2,900	3,400			2,600			
200		2,500	3,000			2,100			
205		2,100	2,500						
210			2,100						
Min Angle	51.0	51.5	52.0	57.0	58.0	58.5	62.5	63.0	63.5
Max Rad.	200.0	206.3	211.3	187.5	195.0	201.3	178.0	186.0	194.0
Capacity	0	0	0	0	0	0	0	0	0

1042130



PORTLAND OFFICE: 503.283.3111
 SEATTLE OFFICE: 206.784.1054
WWW.NESSCAMPBELL.COM

Rated Lifting Capacities in Pounds

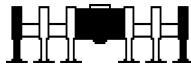

Full

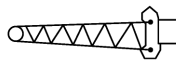

117ft Hydraulic Offset Fly



58,000 lbs



Radius (ft)	Boom Length (ft)											
	Fly Offset											
	44.3			58.9			89.1			120.3		
	2°-15°	15°-30°	30°-45°	2°-15°	15°-30°	30°-45°	2°-15°	15°-30°	30°-45°	2°-15°	15°-30°	30°-45°
25	15,800			16,400								
30	14,500			15,300								
35	12,800	12,800		13,300	13,300		15,600					
40	11,900	11,900		12,400	12,400		14,500			14,400		
45	11,000	11,000		11,600	11,600		12,500	12,500		14,400		
50	10,300	10,000	10,000	10,800	10,400	10,400	11,800	11,800		14,000		
55	9,600	9,400	9,400	10,200	9,800	9,800	11,100	11,100		11,900	11,900	
60	9,000	8,800	8,700	9,600	9,200	9,200	10,500	9,800	9,800	11,300	11,300	
65	8,400	8,300	8,200	9,000	8,700	8,500	10,000	9,400	9,400	10,800	9,900	9,900
70	7,900	7,800	7,800	8,500	8,200	8,100	9,500	8,900	8,500	10,300	9,500	9,500
75	7,500	7,400	7,300	8,000	7,800	7,700	9,000	8,500	8,200	9,800	9,100	9,100
80	6,900	6,900	6,900	7,600	7,400	7,300	8,500	8,100	7,800	9,400	8,700	8,200
85	6,500	6,400	6,400	7,100	6,900	6,900	8,100	7,700	7,500	9,000	8,300	7,900
90	6,100	6,000	6,000	6,700	6,500	6,500	7,800	7,400	7,200	8,600	8,000	7,600
95	5,600	5,600	5,600	6,300	6,200	6,100	7,400	7,000	6,800	8,200	7,700	7,400
100	5,200	5,200	5,300	5,900	5,800	5,800	7,000	6,700	6,500	7,900	7,400	7,100
105	4,800	4,900	4,900	5,500	5,400	5,400	6,600	6,300	6,200	7,600	7,100	6,800
110	4,500	4,500	4,600	5,100	5,100	5,100	6,300	6,000	5,900	7,200	6,800	6,500
115	4,200	4,200	4,200	4,800	4,800	4,800	6,000	5,700	5,600	6,900	6,500	6,200
120	3,900	3,900	3,900	4,500	4,500	4,500	5,600	5,400	5,300	6,600	6,200	6,000
125	3,600	3,600	3,700	4,200	4,200	4,200	5,300	5,200	5,100	6,300	6,000	5,800
130	3,300	3,400	3,400	3,900	3,900	3,900	5,000	4,900	4,800	6,000	5,700	5,500
135	3,100	3,100	3,200	3,700	3,700	3,700	4,700	4,600	4,600	5,700	5,400	5,300
140	2,900	2,900	2,900	3,400	3,400	3,500	4,500	4,400	4,400	5,400	5,200	5,100
145	2,600	2,700		3,200	3,200	3,200	4,200	4,200	4,100	5,200	5,000	4,800
150	2,500	2,500		3,000	3,000	3,000	4,000	3,900	3,900	4,900	4,700	4,600
155				2,800	2,800		3,800	3,700	3,700	4,700	4,500	4,400
160				2,600			3,600	3,500	3,500	4,500	4,300	4,300
165							3,400	3,400	3,400	4,200	4,100	4,100
170							3,200	3,200	3,200	4,000	3,900	3,900
175							3,000	3,000	3,000	3,900	3,800	3,700
180							2,900	2,900	2,900	3,700	3,600	3,600
185							2,700	2,700		3,500	3,400	3,400
190							2,600			3,300	3,300	3,300
195										3,200	3,200	3,200
200										3,000	3,000	3,000
205										2,900	2,900	2,900
210										2,800	2,800	2,800
215										2,500	2,600	
220										2,200		
Min Angle	0.0	0.0	0.0	14.0	25.5	30.0	14.5	24.0	27.0	18.5	25.0	24.5
Max Rad.	152.9	152.4	149.4	165.0	160.0	151.6	195.0	190.0	181.8	223.3	220.0	213.0
Capacity	2,400	2,400	2,500	0	0	0	0	0	0	0	0	0

1042140



PORTLAND OFFICE: 503.283.3111
 SEATTLE OFFICE: 206.784.1054
WWW.NESSCAMPBELL.COM

Rated Lifting Capacities in Pounds

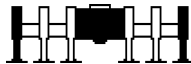

Full

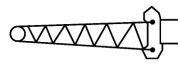

117ft Hydraulic Offset Fly



58,000 lbs



Radius (ft)	Boom Length (ft)								
	Fly Offset								
	152.4			169.0			185.5		
	2°-15°	15°-30°	30°-45°	2°-15°	15°-30°	30°-45°	2°-15°	15°-30°	30°-45°
50	11,500								
55	11,500			10,600					
60	11,500			10,600			9,000		
65	11,400	11,400		10,400	10,400		9,000		
70	11,000	11,000		10,400	10,400		8,900	8,900	
75	10,600	10,600		10,400	10,400		8,900	8,900	
80	10,100	9,200	9,200	10,400	10,400		8,900	8,900	
85	9,700	8,900	8,900	10,100	9,100	9,100	8,900	8,900	
90	9,300	8,500	8,000	9,700	8,800	8,800	8,900	8,700	8,700
95	9,000	8,200	7,700	9,300	8,500	7,900	8,900	8,700	8,700
100	8,600	8,000	7,500	9,000	8,200	7,700	8,900	8,400	7,800
105	8,300	7,700	7,300	8,700	7,900	7,400	8,900	8,200	7,600
110	8,000	7,400	7,000	8,400	7,700	7,200	8,700	7,900	7,400
115	7,700	7,100	6,700	8,100	7,400	7,000	8,400	7,700	7,200
120	7,400	6,900	6,500	7,800	7,200	6,700	8,100	7,400	6,900
125	7,100	6,600	6,300	7,500	6,900	6,500	7,900	7,200	6,700
130	6,800	6,400	6,100	7,200	6,700	6,300	7,600	6,900	6,500
135	6,600	6,100	5,900	7,000	6,400	6,100	7,300	6,700	6,300
140	6,300	5,900	5,700	6,700	6,200	5,900	6,900	6,500	6,100
145	6,100	5,700	5,500	6,400	6,000	5,700	6,000	6,300	5,900
150	5,800	5,500	5,300	6,200	5,800	5,500	5,300	6,100	5,800
155	5,600	5,200	5,100	5,500	5,600	5,300	4,600	5,600	5,600
160	5,300	5,000	4,900	4,900	5,400	5,100	3,900	4,900	5,400
165	5,100	4,800	4,700	4,300	5,100	5,000	3,300	4,200	5,100
170	4,700	4,600	4,500	3,700	4,500	4,800	2,700	3,600	4,500
175	4,200	4,500	4,400	3,100	3,900	4,600	2,200	3,000	3,900
180	3,700	4,300	4,200	2,600	3,400	4,000		2,500	3,300
185	3,200	3,800	4,000	2,200	2,800	3,500			2,700
190	2,800	3,300	3,800		2,400	3,000			2,200
195	2,300	2,900	3,300			2,500			
200		2,400	2,900						
205			2,400						
Min Angle	46.5	47.0	47.0	54.0	54.5	55.0	59.5	60.0	60.5
Max Rad.	198.8	205.0	210.0	187.0	194.0	200.0	177.0	185.0	192.0
Capacity	0	0	0	0	0	0	0	0	0

1042140



PORTLAND OFFICE: 503.283.3111
 SEATTLE OFFICE: 206.784.1054
WWW.NESSCAMPBELL.COM

Rated Lifting Capacities in Pounds

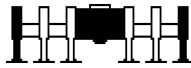

Full

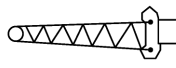

117ft Hydraulic Offset Fly



58,000 lbs



Radius (ft)	Boom Length (ft)											
	Fly Offset											
	44.3			73.5			103.8			119.4		
	2°-15°	15°-30°	30°-45°	2°-15°	15°-30°	30°-45°	2°-15°	15°-30°	30°-45°	2°-15°	15°-30°	30°-45°
25	15,800											
30	14,500			14,800								
35	12,800	12,800		14,800			13,100					
40	11,900	11,900		12,900	12,900		13,100			12,800		
45	11,000	11,000		12,000	12,000		13,100			12,800		
50	10,300	10,000	10,000	11,300	11,300		12,200	12,200		12,800		
55	9,600	9,400	9,400	10,700	10,100	10,100	11,500	11,500		11,900	11,900	
60	9,000	8,800	8,700	10,000	9,500	9,500	10,900	10,900		11,300	11,300	
65	8,400	8,300	8,200	9,500	9,000	8,700	10,400	9,600	9,600	10,800	10,800	
70	7,900	7,800	7,800	9,000	8,600	8,300	9,900	9,200	9,200	10,300	9,500	9,500
75	7,500	7,400	7,300	8,500	8,200	7,900	9,400	8,800	8,400	9,800	9,100	9,100
80	6,900	6,900	6,900	8,100	7,800	7,600	9,000	8,400	8,000	9,400	8,700	8,200
85	6,500	6,400	6,400	7,700	7,400	7,200	8,500	8,000	7,700	9,000	8,300	7,900
90	6,100	6,000	6,000	7,200	7,000	6,800	8,200	7,700	7,400	8,600	8,000	7,600
95	5,600	5,600	5,600	6,800	6,600	6,500	7,800	7,400	7,100	8,200	7,700	7,300
100	5,200	5,200	5,300	6,400	6,200	6,100	7,500	7,000	6,800	7,900	7,400	7,000
105	4,800	4,900	4,900	6,100	5,900	5,800	7,100	6,700	6,500	7,600	7,100	6,800
110	4,500	4,500	4,600	5,700	5,600	5,500	6,700	6,400	6,200	7,200	6,800	6,500
115	4,200	4,200	4,200	5,400	5,300	5,200	6,400	6,100	5,900	6,900	6,500	6,200
120	3,900	3,900	3,900	5,000	5,000	4,900	6,100	5,800	5,700	6,600	6,200	6,000
125	3,600	3,600	3,700	4,700	4,700	4,700	5,800	5,600	5,400	6,300	5,900	5,700
130	3,300	3,400	3,400	4,500	4,400	4,400	5,500	5,300	5,200	6,000	5,700	5,500
135	3,100	3,100	3,200	4,200	4,200	4,200	5,200	5,000	4,900	5,700	5,400	5,300
140	2,900	2,900	2,900	3,900	3,900	3,900	4,900	4,800	4,700	5,400	5,200	5,000
145	2,600	2,700		3,700	3,700	3,700	4,700	4,500	4,500	5,100	4,900	4,800
150	2,500	2,500		3,500	3,500	3,500	4,400	4,300	4,300	4,900	4,700	4,600
155				3,300	3,300	3,300	4,200	4,100	4,100	4,700	4,500	4,400
160				3,100	3,100	3,100	4,000	3,900	3,900	4,400	4,300	4,200
165				2,900	2,900	2,900	3,800	3,700	3,700	4,200	4,100	4,100
170				2,700	2,700		3,600	3,500	3,500	4,000	3,900	3,900
175				2,600			3,400	3,400	3,400	3,800	3,700	3,700
180							3,200	3,200	3,200	3,700	3,600	3,600
185							3,100	3,100	3,100	3,500	3,400	3,400
190							2,900	2,900	2,900	3,300	3,300	3,300
195							2,800	2,800	2,800	3,200	3,100	3,100
200							2,600	2,600		3,000	3,000	3,000
205							2,500			2,900	2,900	2,900
210										2,700	2,700	2,700
215										2,600	2,600	
220										2,500		
Min Angle	0.0	0.0	0.0	13.5	24.0	29.5	15.0	23.5	27.5	16.5	24.0	26.0
Max Rad.	152.9	152.4	149.4	180.0	175.0	166.2	210.0	205.0	196.4	225.0	220.0	212.0
Capacity	2,400	2,400	2,500	0	0	0	0	0	0	0	0	0

1042150



PORTLAND OFFICE: 503.283.3111
 SEATTLE OFFICE: 206.784.1054
WWW.NESSCAMPBELL.COM

Rated Lifting Capacities in Pounds

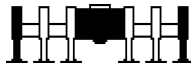

Full

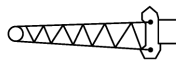

117ft Hydraulic Offset Fly



58,000 lbs



Radius (ft)	Boom Length (ft)								
	Fly Offset								
	135.4			152.0			168.5		
	2°-15°	15°-30°	30°-45°	2°-15°	15°-30°	30°-45°	2°-15°	15°-30°	30°-45°
45	12,700								
50	12,700			11,900			10,200		
55	12,700			11,900			10,200		
60	11,700	11,700		11,700	11,700		10,200		
65	11,100	11,100		11,500	11,500		10,000	10,000	
70	10,700	9,700	9,700	11,000	11,000		10,000	10,000	
75	10,200	9,300	9,300	10,500	9,500	9,500	10,000	10,000	
80	9,800	8,900	8,900	10,100	9,200	9,200	10,000	10,000	
85	9,300	8,600	8,100	9,700	8,900	8,300	10,000	9,100	9,100
90	9,000	8,300	7,800	9,300	8,500	8,000	9,700	8,800	8,800
95	8,600	8,000	7,500	9,000	8,200	7,700	9,300	8,500	7,900
100	8,300	7,700	7,300	8,600	8,000	7,500	9,000	8,200	7,700
105	7,900	7,400	7,000	8,300	7,700	7,300	8,700	7,900	7,400
110	7,600	7,100	6,700	8,000	7,400	7,000	8,300	7,700	7,200
115	7,300	6,800	6,500	7,700	7,100	6,700	8,100	7,400	7,000
120	7,000	6,500	6,200	7,400	6,900	6,500	7,800	7,200	6,700
125	6,700	6,300	6,000	7,100	6,600	6,300	7,500	6,900	6,500
130	6,400	6,000	5,800	6,800	6,400	6,100	7,200	6,700	6,300
135	6,100	5,800	5,600	6,600	6,100	5,800	7,000	6,400	6,100
140	5,900	5,600	5,400	6,300	5,900	5,600	6,700	6,200	5,900
145	5,600	5,300	5,100	6,000	5,700	5,400	6,400	6,000	5,700
150	5,400	5,100	4,900	5,800	5,400	5,200	6,200	5,800	5,500
155	5,100	4,900	4,700	5,500	5,200	5,000	5,600	5,600	5,300
160	4,900	4,700	4,600	5,300	5,000	4,900	4,900	5,400	5,100
165	4,700	4,500	4,400	5,100	4,800	4,700	4,300	5,100	5,000
170	4,400	4,300	4,200	4,800	4,600	4,500	3,700	4,500	4,800
175	4,200	4,100	4,000	4,200	4,400	4,300	3,200	3,900	4,600
180	4,100	3,900	3,900	3,700	4,300	4,200	2,700	3,400	4,100
185	3,900	3,800	3,700	3,300	3,800	4,000	2,200	2,900	3,500
190	3,700	3,600	3,600	2,800	3,400	3,900		2,400	3,000
195	3,500	3,500	3,500	2,400	2,900	3,400			2,500
200	3,200	3,300	3,300		2,500	2,900			
205	2,800	3,200	3,200		2,100	2,500			
210	2,400	2,800	3,000						
215	2,100	2,400	2,600						
220			2,100						
Min Angle	33.5	34.5	34.0	45.5	46.0	47.0	53.0	54.5	55.0
Max Rad. Capacity	216.7	220.0	221.3	200.0	206.3	210.0	187.5	194.0	200.0
	0	0	0	0	0	0	0	0	0

1042150



PORTLAND OFFICE: 503.283.3111
 SEATTLE OFFICE: 206.784.1054
WWW.NESSCAMPBELL.COM

Rated Lifting Capacities in Pounds

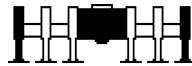

Full



71,500 lbs



Boom Length (ft)											
Extend Mode											
Radius (ft)	44.3	58.9	59.4	59.9	73.5	74.0	75.0	75.9	88.7	89.1	89.6
	ALL	EM2, EM5	EM6	EM7	EM1, EM3, EM4	EM5	EM6	EM7	EM4	EM2	EM5
10	290,600	195,200	291,500	290,700	134,800	196,100	247,000	262,200	125,300	120,100	168,700
12	262,000	182,900	263,600	262,700	125,600	182,200	228,300	256,800	117,000	112,200	168,700
15	226,400	167,200	228,700	227,800	114,000	164,700	205,000	227,100	106,200	102,000	161,600
20	182,600	146,500	185,900	185,000	98,600	141,800	175,200	184,800	91,900	88,500	140,000
25	143,500	130,500	147,700	146,500	86,700	124,400	148,900	146,700	80,800	78,000	123,300
30	116,800	117,900	121,200	119,900	75,900	110,800	122,400	120,300	72,100	69,600	110,000
35	97,400	102,800	101,800	100,600	67,200	99,800	103,200	101,100	65,000	62,800	99,200
40		88,000	87,100	85,900	60,000	90,200	88,500	86,400	59,100	57,100	90,200
45		74,700	73,500	72,100	54,100	77,300	75,200	72,600	54,100	51,700	77,700
50		58,500	61,400	59,900	49,300	65,200	63,200	60,700	49,900	47,100	65,600
55					45,200	55,700	53,800	51,500	46,200	43,300	56,300
60					41,900	48,300	46,400	44,100	43,100	39,900	49,100
65						42,400	40,500	38,200	40,300	37,000	43,000
70									37,900	34,400	38,000
75									35,400	32,200	33,900
80									25,000	30,300	30,400
Unpinned		101,200	89,600	80,400	55,600	95,600	89,600	72,800	98,200	56,000	83,900
Min Angle	0.0	0.0	0.0	0.0	0.0	0.0	0.0	0.0	0.0	0.0	0.0
Max Rad. Capacity	35.7	50.4	50.8	51.3	65.0	65.5	66.4	67.4	80.1	80.6	81.1
Capacity	66,600	22,600	48,400	47,000	12,200	19,400	36,200	33,900	10,700	16,400	16,100

1050010



PORTLAND OFFICE: 503.283.3111
 SEATTLE OFFICE: 206.784.1054
WWW.NESSCAMPBELL.COM

Rated Lifting Capacities in Pounds

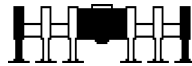

Full



71,500 lbs



360°

Radius (ft)	Boom Length (ft)											
	Extend Mode											
	91.0	92.5	103.8	104.2	105.7	107.6	119.4	120.3	120.3	122.2	124.1	134.9
	EM6	EM7	EM1, EM3	EM4	EM5	EM6	EM3	EM4	EM2	EM5	EM6	EM1
10	212,200	203,700										
12	212,200	203,700										
15	198,500	203,700	84,300	100,600	128,900							
20	169,700	183,400	76,600	97,200	128,900	172,300	66,300	92,800	77,300	120,900	129,700	54,700
25	148,100	145,300	67,600	86,600	124,700	146,700	66,300	91,000	69,400	120,900	112,800	54,700
30	122,000	119,100	60,300	78,100	111,500	120,700	64,000	82,700	62,100	118,300	99,400	54,700
35	103,000	100,000	54,400	71,000	100,600	101,700	58,200	75,900	56,200	103,300	88,400	52,400
40	88,300	85,400	49,500	65,000	90,100	87,000	53,300	70,000	51,200	88,700	79,400	47,800
45	74,700	71,000	45,300	60,000	76,900	73,000	48,900	64,900	46,900	75,000	71,700	43,800
50	62,800	59,200	41,700	55,700	64,800	61,200	45,100	60,500	43,200	63,100	59,900	40,400
55	53,600	50,300	38,700	51,900	55,500	52,000	41,800	56,700	40,000	53,800	51,000	37,400
60	46,400	43,100	36,000	48,600	48,300	44,900	38,900	49,800	37,200	46,700	43,800	34,800
65	40,400	37,200	33,400	44,700	42,400	39,100	36,400	43,800	34,700	40,900	38,000	32,400
70	35,500	32,500	31,000	39,700	37,500	34,400	34,100	38,900	32,500	36,000	33,400	30,400
75	31,400	28,400	28,900	35,500	33,500	30,300	32,100	34,800	30,500	32,100	29,300	28,500
80	27,900	24,900	27,100	32,100	29,900	26,800	30,300	31,400	28,700	28,600	25,900	26,800
85			25,400	29,000	26,900	23,800	28,600	28,400	27,100	25,600	23,000	25,300
90			24,000	26,300	24,200	21,100	27,000	25,700	25,600	23,000	20,300	23,900
95			21,700	24,000	21,900	18,900	24,600	23,300	23,600	20,600	18,000	22,600
100							22,600	21,300	21,500	18,600	16,100	21,400
105							20,700	19,400	19,700	16,800	14,300	20,300
110							19,100	17,800	18,100	15,200	12,600	19,000
115											11,200	17,500
120												16,300
125												15,100
Unpinned	74,300	60,200	60,700	86,100	75,900	61,400	66,300	77,900	60,700	61,800	44,600	54,700
Min Angle	0.0	0.0	0.0	0.0	0.0	0.0	0.0	0.0	0.0	0.0	0.0	0.0
Max Rad.	82.5	83.9	95.2	95.7	97.1	99.0	110.8	111.7	111.8	113.7	115.6	126.4
Capacity	26,400	22,500	9,400	9,100	12,800	17,300	7,900	7,300	11,300	9,500	11,000	6,700

1050010



PORTLAND OFFICE: 503.283.3111
 SEATTLE OFFICE: 206.784.1054
WWW.NESSCAMPBELL.COM

Rated Lifting Capacities in Pounds

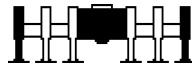

Full



71,500 lbs



Boom Length (ft)											
Extend Mode											
Radius (ft)	135.4	136.8	152.0	152.4	153.4	167.1	168.5	169.0	183.6	185.5	200.1
	EM3	EM4	EM3	EM2	EM4	EM1	EM3	EM2	EM1	EM2	EM1
20	65,600	91,400									
25	65,600	91,400	65,300	57,200	73,000	41,200					
30	65,600	85,500	65,300	57,200	73,000	41,200	55,000	53,300	38,700	41,300	
35	61,700	79,100	64,100	54,500	73,000	41,200	55,000	53,300	38,700	41,300	33,000
40	57,000	73,500	59,600	49,800	69,700	41,200	55,000	52,200	38,700	41,300	33,000
45	52,800	68,600	55,600	45,700	63,800	41,200	55,000	48,200	38,700	41,300	33,000
50	49,100	64,100	52,100	41,900	58,600	40,500	53,500	44,300	38,700	41,300	33,000
55	45,800	55,300	48,900	38,800	53,900	37,600	50,500	41,300	38,700	41,300	33,000
60	42,700	48,200	46,100	36,000	46,900	34,900	47,600	38,500	37,200	40,200	33,000
65	40,100	42,200	42,900	33,600	41,000	32,500	41,700	36,100	34,800	37,800	33,000
70	37,700	37,300	38,000	31,300	36,100	30,400	36,800	33,800	32,700	35,600	33,000
75	35,300	33,400	34,100	29,300	32,200	28,500	32,900	31,800	30,700	31,900	32,600
80	32,000	29,900	30,600	27,500	28,800	26,700	29,500	29,400	29,000	28,500	29,300
85	29,000	26,900	27,600	25,900	25,800	25,100	26,500	26,400	27,300	25,500	26,300
90	26,300	24,300	25,000	24,400	23,200	23,700	23,800	23,800	24,600	22,900	23,700
95	24,000	22,000	22,700	22,600	20,900	22,200	21,500	21,500	22,300	20,600	21,400
100	21,900	19,900	20,600	20,500	18,900	21,000	19,500	19,500	20,300	18,500	19,400
105	20,100	18,100	18,800	18,700	17,200	19,600	17,700	17,600	18,500	17,000	17,600
110	18,400	16,600	17,100	17,200	15,600	17,900	16,300	16,200	17,100	15,400	16,200
115	17,000	15,100	15,800	15,700	14,100	16,600	14,800	14,800	15,600	13,900	14,700
120	15,700	13,700	14,400	14,400	12,700	15,300	13,500	13,400	14,300	12,600	13,400
125	14,400	12,500	13,200	13,100	11,500	14,000	12,200	12,200	13,100	11,400	12,200
130			12,100	12,000	10,400	12,900	11,100	11,100	11,900	10,300	11,100
135			11,000	11,000	9,400	11,900	10,100	10,000	10,900	9,300	10,100
140			10,100	10,000	8,400	10,900	9,100	9,100	9,900	8,300	9,200
145						10,000	8,300	8,200	9,100	7,400	8,300
150						9,200	7,400	7,400	8,200	6,600	7,500
155						8,500	6,700	6,600	7,500	5,900	6,700
160								6,000	6,800	5,200	6,000
165									6,100	4,500	5,300
170									5,500	3,900	4,700
175										3,400	4,100
180											3,600
185											3,100
Unpinned	65,600	63,400	65,200	57,200	63,200	41,200	55,000	53,300	38,700	41,300	33,000
Min Angle	0.0	0.0	0.0	0.0	0.0	0.0	0.0	0.0	0.0	0.0	12.0
Max Rad. Capacity	126.9	128.3	143.4	143.9	144.8	158.5	159.9	160.4	175.1	177.0	190.0
Capacity	6,400	5,300	4,500	7,000	3,500	4,000	2,900	4,800	2,500	2,900	0

1050010



PORTLAND OFFICE: 503.283.3111
 SEATTLE OFFICE: 206.784.1054
WWW.NESSCAMPBELL.COM

Rated Lifting Capacities in Pounds

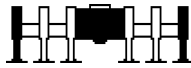

Full

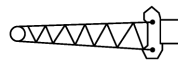

12ft Offset Fly
2° - 45°



71,500 lbs



Boom Length (ft)											
Extend Mode											
Radius (ft)	44.3	58.9	59.4	59.9	73.5	74.0	75.0	75.9	88.7	89.1	89.6
	ALL	EM2, EM5	EM6	EM7	EM1, EM3, EM4	EM5	EM6	EM7	EM4	EM2	EM5
10	69,600	69,500	69,500	69,500	69,400	69,400	69,400	69,400	69,400	69,400	69,300
12	69,600	69,500	69,500	69,500	69,400	69,400	69,400	69,400	69,400	69,400	69,300
15	69,600	69,500	69,500	69,500	69,400	69,400	69,400	69,400	69,400	69,400	69,300
20	69,600	69,500	69,500	69,500	69,400	69,400	69,400	69,400	69,400	69,400	69,300
25	69,600	69,500	69,500	69,500	69,400	69,400	69,400	69,400	69,400	69,400	69,300
30	66,700	69,500	69,500	69,500	64,100	69,400	69,400	69,400	63,700	62,300	69,300
35	61,800	69,400	69,500	69,500	57,500	69,400	69,400	69,400	57,200	56,000	69,300
40	57,700	66,200	69,500	69,500	51,300	69,400	69,400	69,400	51,900	50,700	69,300
45	54,700	62,300	65,800	66,100	46,300	68,600	69,400	69,400	47,400	46,300	69,300
50		59,000	62,200	62,300	42,600	65,600	63,700	61,500	43,900	42,600	65,400
55		55,400	54,400	53,200	39,000	56,300	54,500	52,300	40,600	38,900	56,100
60		48,200	47,300	46,100	35,900	49,100	47,300	45,200	37,700	35,800	48,900
65					33,200	43,100	41,400	39,400	35,100	33,000	42,900
70					30,900	38,300	36,600	34,700	32,900	30,600	38,000
75					28,900	34,300	32,700	30,700	30,900	28,500	34,100
80									29,100	26,600	30,600
85									27,600	25,000	27,600
90									26,200	23,500	25,100
Unpinned		69,500	69,500	69,500	55,600	69,400	69,400	69,400	69,400	56,000	69,300
Min Angle	0.0	0.0	0.0	0.0	0.0	0.0	0.0	0.0	0.0	0.0	0.0
Max Rad.	46.4	61.0	61.5	61.9	75.6	76.1	77.0	78.0	90.7	91.2	91.7
Capacity	30,500	14,600	25,100	24,400	7,900	12,500	20,600	19,300	6,800	10,700	10,400

1053010



PORTLAND OFFICE: 503.283.3111
 SEATTLE OFFICE: 206.784.1054
WWW.NESSCAMPBELL.COM

Rated Lifting Capacities in Pounds

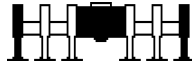

Full

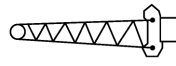

12ft Offset Fly
2° - 45°



71,500 lbs



360°

		Boom Length (ft)										
		Extend Mode										
Radius (ft)	91.0	92.5	103.8	104.2	105.7	107.6	119.4	120.3	120.3	122.2	124.1	134.9
	EM6	EM7	EM1, EM3	EM4	EM5	EM6	EM3	EM4	EM2	EM5	EM6	EM1
10	69,300	69,300										
12	69,300	69,300										
15	69,300	69,300	62,700	69,300	69,300	69,200	54,600	69,200	61,000	69,200	69,100	
20	69,300	69,300	62,700	69,300	69,300	69,200	54,600	69,200	61,000	69,200	69,100	42,600
25	69,300	69,300	61,800	69,300	69,300	69,200	54,600	69,200	61,000	69,200	69,100	42,600
30	69,300	69,300	55,000	68,300	69,300	69,200	54,600	69,200	58,300	69,200	69,100	42,600
35	69,300	69,300	49,400	62,100	69,300	69,200	52,600	66,100	52,500	69,200	69,100	42,600
40	69,300	69,300	45,000	56,700	69,300	69,200	48,000	60,800	47,700	69,200	69,100	42,600
45	69,300	69,300	41,100	52,100	69,300	69,200	44,300	56,200	43,700	69,200	69,100	41,000
50	62,800	59,500	37,700	48,200	64,300	60,900	40,900	52,200	40,100	62,400	59,400	37,700
55	53,600	50,500	34,800	45,000	55,000	51,900	37,900	48,700	37,000	53,200	50,500	34,800
60	46,400	43,400	32,200	42,000	47,900	44,600	35,300	45,700	34,300	46,100	43,300	32,200
65	40,500	37,600	30,000	39,300	41,900	38,800	33,000	43,000	31,900	40,200	37,500	29,900
70	35,700	32,900	27,900	37,000	37,100	34,100	31,000	38,100	29,700	35,400	32,900	27,900
75	31,800	28,900	25,900	34,800	33,100	30,100	29,100	34,100	27,800	31,500	28,900	26,000
80	28,300	25,500	24,200	31,600	29,600	26,700	27,400	30,600	26,000	28,000	25,400	24,400
85	25,400	22,600	22,600	28,600	26,600	23,700	25,700	27,600	24,500	25,000	22,500	22,900
90	22,800	20,100	21,500	26,000	24,000	21,200	24,200	25,000	23,100	22,400	19,900	21,700
95			20,100	23,700	21,800	18,900	22,800	22,700	21,800	20,200	17,700	20,400
100			18,900	21,700	19,800	17,000	21,800	20,700	20,600	18,200	15,900	19,300
105			17,900	19,900	18,000	15,300	20,100	18,900	19,100	16,500	14,100	18,200
110							18,500	17,300	17,500	14,900	12,500	17,300
115							17,100	15,900	16,200	13,500	11,100	16,400
120							15,800	14,600	14,900	12,200	9,800	15,500
125											8,700	14,300
130												13,200
135												12,200
Unpinned	69,300	60,200	60,700	69,300	69,300	61,400	54,600	69,200	60,700	61,800	44,600	42,600
Min Angle	0.0	0.0	0.0	0.0	0.0	0.0	0.0	0.0	0.0	0.0	0.0	0.0
Max Rad.	93.1	94.5	105.8	106.3	107.7	109.7	121.4	122.4	122.4	124.3	126.2	137.0
Capacity	16,000	14,000	5,900	5,600	8,100	11,600	4,800	4,200	7,200	5,700	8,000	3,800

1053010



PORTLAND OFFICE: 503.283.3111
 SEATTLE OFFICE: 206.784.1054
WWW.NESSCAMPBELL.COM

Rated Lifting Capacities in Pounds

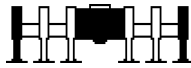

Full

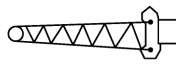

12ft Offset Fly
2° - 45°



71,500 lbs



360°

Boom Length (ft)											
Extend Mode											
Radius (ft)	135.4	136.8	152.0	152.4	153.4	167.1	168.5	169.0	183.6	185.5	200.1
	EM3	EM4	EM3	EM2	EM4	EM1	EM3	EM2	EM1	EM2	EM1
25	55,600	69,100	55,000	49,300	59,000	35,100	43,000	42,100			
30	55,600	69,100	55,000	49,100	59,000	35,100	43,000	42,100	32,900	35,400	
35	55,600	68,900	55,000	49,100	59,000	35,100	43,000	42,100	32,900	35,400	28,100
40	51,100	63,800	53,400	47,200	59,000	35,100	43,000	42,100	32,900	35,400	28,100
45	47,200	59,300	49,600	43,200	59,000	35,100	43,000	42,100	32,900	35,400	28,100
50	43,900	55,400	46,300	39,700	56,500	35,100	43,000	41,800	32,900	35,400	28,100
55	40,900	52,000	43,300	36,600	52,000	35,100	43,000	38,800	32,900	35,400	28,100
60	38,200	47,200	40,700	33,900	45,800	32,800	42,100	36,100	32,900	35,400	28,100
65	35,900	41,300	38,300	31,400	39,900	30,400	39,800	33,700	32,500	35,200	28,100
70	33,800	36,400	36,200	29,300	35,100	28,300	35,600	31,500	30,400	33,100	28,100
75	31,900	32,500	33,000	27,300	31,300	26,400	31,800	29,500	28,500	30,700	28,100
80	30,200	29,100	29,500	25,500	27,800	24,700	28,300	27,700	26,700	27,300	28,000
85	28,000	26,100	26,500	23,900	24,800	23,100	25,300	25,300	25,100	24,300	25,000
90	25,400	23,400	23,900	22,400	22,200	21,800	22,700	22,700	23,400	21,700	22,400
95	23,100	21,200	21,600	21,000	19,900	20,500	20,400	20,400	21,100	19,400	20,100
100	21,000	19,100	19,600	19,500	17,900	19,300	18,400	18,400	19,100	17,400	18,100
105	19,200	17,300	17,800	17,700	16,300	18,100	16,900	16,800	17,300	15,900	16,600
110	17,600	15,900	16,400	16,300	14,700	17,000	15,200	15,200	15,900	14,200	15,000
115	16,300	14,400	14,900	14,800	13,300	15,500	13,800	13,700	14,400	12,800	13,500
120	14,900	13,100	13,600	13,500	11,900	14,200	12,400	12,400	13,100	11,500	12,200
125	13,700	11,900	12,400	12,300	10,700	13,000	11,200	11,200	11,900	10,300	11,000
130	12,600	10,800	11,300	11,200	9,700	11,900	10,100	10,100	10,800	9,200	9,900
135	11,700	9,900	10,200	10,200	8,700	10,800	9,100	9,100	9,800	8,200	8,900
140			9,300	9,300	7,700	9,900	8,200	8,200	8,800	7,300	7,900
145			8,500	8,400	6,900	9,000	7,400	7,300	8,000	6,400	7,100
150				7,600	6,100	8,300	6,600	6,500	7,200	5,600	6,300
155						7,500	5,900	5,800	6,400	4,900	5,600
160						6,800	5,200	5,100	5,800	4,200	4,900
165							4,600	4,500	5,100	3,600	4,200
170								4,000	4,500	3,000	3,600
175									4,000	2,400	3,100
180									3,500		2,600
185											2,100
Unpinned	55,600	63,400	55,000	49,300	59,000	35,100	43,000	42,100	32,900	35,400	28,100
Min Angle	0.0	0.0	18.0	0.0	10.0	17.0	10.5	0.0	10.5	21.5	27.0
Max Rad.	137.5	138.9	150.0	154.5	155.0	165.0	170.0	171.0	185.0	179.0	186.0
Capacity	3,500	2,600	0	3,900	0	0	0	2,200	0	0	0

1053010



PORTLAND OFFICE: 503.283.3111
 SEATTLE OFFICE: 206.784.1054
WWW.NESSCAMPBELL.COM

Rated Lifting Capacities in Pounds

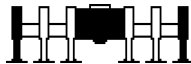

Full

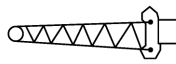

40ft Offset Fly



71,500 lbs



Boom Length (ft)												
Fly Offset												
Radius (ft)	44.3				73.5				103.8			
	2°	15°	30°	45°	2°	15°	30°	45°	2°	15°	30°	45°
10	34,700											
12	34,700				34,600							
15	34,700	34,700			34,600							
20	34,700	32,000			34,600	34,600			34,500			
25	33,900	28,800	24,900		34,600	32,900			34,500			
30	30,200	26,200	22,900	20,200	34,600	30,300	25,100		34,500	33,500		
35	27,200	24,000	20,700	19,000	34,500	28,100	23,600	20,300	34,500	31,400	25,200	
40	24,800	21,400	19,400	18,000	31,600	26,200	21,700	19,500	34,500	29,500	24,000	20,400
45	21,900	19,900	18,200	17,200	29,100	24,600	20,700	18,700	34,500	27,800	23,000	19,700
50	20,200	18,600	17,300	16,400	27,000	23,100	19,700	18,000	32,500	26,300	21,500	19,100
55	18,800	17,500	16,400	15,800	25,100	21,200	18,900	17,400	30,400	25,000	20,700	18,500
60	17,500	16,500	15,700	15,300	23,500	20,100	18,100	16,900	28,600	23,800	20,000	18,000
65	16,400	15,600	15,000	14,900	21,400	19,200	17,400	16,400	26,700	22,700	19,300	17,500
70	15,400	14,900	14,600		20,200	18,300	16,800	15,900	24,800	21,200	18,600	17,100
75	14,500	14,300			19,200	17,500	16,200	15,600	23,200	20,400	18,000	16,700
80					18,200	16,800	15,700	15,300	22,000	19,600	17,500	16,400
85					17,300	16,100	15,300	15,000	20,600	18,800	17,000	16,000
90					16,500	15,500	14,900		19,400	18,200	16,600	15,700
95					15,700	15,000	14,600		18,100	17,600	16,200	15,500
100					15,100	14,600			17,000	17,000	15,800	15,300
105					9,500				16,000	16,000	15,400	15,100
110									15,100	15,100	15,100	14,900
115									14,300	14,300	14,300	
120									13,500	13,500	13,500	
125									12,800	12,800	12,800	
130									12,200	12,200		
135									8,800			
Min Angle	0.0	0.0	0.0	0.0	0.0	0.0	0.0	0.0	0.0	0.0	0.0	0.0
Max Rad.	75.9	75.8	74.5	71.9	105.1	104.9	103.2	100.0	135.3	135.1	133.1	129.6
Capacity	11,200	11,400	12,100	13,600	3,700	3,700	3,900	4,200	2,600	2,600	2,700	2,900

1051040



PORTLAND OFFICE: 503.283.3111
 SEATTLE OFFICE: 206.784.1054
WWW.NESSCAMPBELL.COM

Rated Lifting Capacities in Pounds

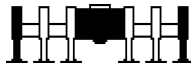

Full

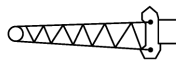

40ft Offset Fly

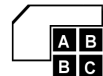

71,500 lbs



Radius (ft)	Boom Length (ft)											
	Fly Offset											
	134.9				167.1				183.6			
	2°	15°	30°	45°	2°	15°	30°	45°	2°	15°	30°	45°
25	29,700											
30	29,700				19,800							
35	29,700	29,500			19,800				18,600			
40	29,700	29,500			19,800	19,700			18,600			
45	29,700	29,500	24,300		19,800	19,700			18,600	18,500		
50	29,700	29,000	23,400	19,900	19,800	19,700	19,600		18,600	18,500		
55	29,700	27,700	22,100	19,300	19,800	19,700	19,600		18,600	18,500	18,300	
60	29,700	26,400	21,400	18,900	19,800	19,700	19,600	19,300	18,600	18,500	18,300	18,000
65	27,800	25,300	20,700	18,400	19,800	19,700	19,600	19,100	18,600	18,500	18,300	18,000
70	25,800	24,300	20,100	18,000	19,800	19,700	19,600	18,700	18,600	18,500	18,300	18,000
75	24,100	23,400	19,600	17,600	19,800	19,700	19,600	18,400	18,600	18,500	18,300	18,000
80	22,500	22,000	19,000	17,300	19,800	19,700	19,600	18,000	18,600	18,500	18,300	18,000
85	21,300	21,200	18,500	17,000	19,800	19,700	19,600	17,700	18,600	18,500	18,300	18,000
90	20,000	19,900	18,000	16,600	19,800	19,700	19,300	17,400	18,600	18,500	18,300	17,700
95	18,800	18,800	17,600	16,400	19,300	19,400	18,900	17,100	18,600	18,500	18,300	17,500
100	17,700	17,700	17,200	16,100	18,200	18,300	18,300	16,900	18,600	18,500	18,300	17,200
105	16,700	16,700	16,700	15,800	17,100	17,200	17,300	16,600	18,200	18,500	18,300	16,900
110	15,800	15,800	15,800	15,600	16,100	16,200	16,300	16,400	16,900	17,300	17,500	16,700
115	15,000	15,000	15,000	15,000	15,200	15,300	15,400	15,500	15,400	16,100	16,600	16,500
120	14,200	14,200	14,200	14,200	14,300	14,500	14,600	14,700	14,000	14,700	15,400	15,800
125	13,500	13,500	13,500	13,500	13,500	13,700	13,800	13,900	12,800	13,400	14,000	14,500
130	12,800	12,800	12,800	12,900	12,700	12,900	13,100	13,100	11,700	12,300	12,800	13,200
135	12,100	12,200	12,200	12,200	11,700	12,200	12,400	12,400	10,600	11,200	11,700	12,100
140	11,500	11,600	11,600		10,700	11,200	11,600	11,800	9,700	10,200	10,700	11,000
145	11,000	11,000	11,100		9,900	10,300	10,700	10,900	8,800	9,300	9,700	10,000
150	10,500	10,500	10,500		9,100	9,400	9,800	9,900	8,000	8,400	8,900	9,100
155	9,800	10,000	10,000		8,300	8,700	8,900	9,100	7,200	7,700	8,000	8,200
160	9,100	9,200			7,600	7,900	8,200	8,300	6,500	6,900	7,300	7,400
165					6,900	7,200	7,500		5,900	6,200	6,500	6,700
170					6,300	6,600	6,800		5,300	5,600	5,900	6,000
175					5,800	6,000	6,100		4,700	5,000	5,200	5,300
180					5,200	5,400	5,500		4,200	4,400	4,600	
185					4,700	4,900	5,000		3,700	3,900	4,100	
190					4,300	4,400			3,200	3,400	3,500	
195									2,700	2,900	3,000	
200									2,300	2,500	2,500	
205										2,100		
Min Angle	13.0	14.5	23.0	4.0	16.0	17.5	15.5	20.0	23.5	23.0	23.0	22.0
Max Rad. Capacity	165.0	165.0	160.0	158.4	195.0	195.0	195.0	190.0	203.8	206.3	206.0	204.0
	0	0	0	0	0	0	0	0	0	0	0	0

1051040



PORTLAND OFFICE: 503.283.3111
 SEATTLE OFFICE: 206.784.1054
WWW.NESSCAMPBELL.COM

Rated Lifting Capacities in Pounds

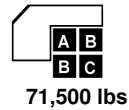
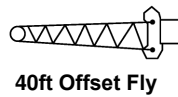
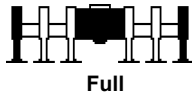

Radius (ft)	Boom Length (ft)			
	Fly Offset			
	200.1			
	2°	15°	30°	45°
40	16,100			
45	16,100			
50	16,100	16,100		
55	16,100	16,100		
60	16,100	16,100	15,900	
65	16,100	16,100	15,900	15,600
70	16,100	16,100	15,900	15,600
75	16,100	16,100	15,900	15,600
80	16,100	16,100	15,900	15,600
85	16,100	16,100	15,900	15,600
90	16,100	16,100	15,900	15,600
95	16,100	16,100	15,900	15,600
100	16,100	16,100	15,900	15,600
105	16,100	16,100	15,900	15,600
110	15,900	16,100	15,900	15,600
115	14,400	15,200	15,900	15,600
120	13,100	13,800	14,600	15,100
125	11,800	12,600	13,200	13,700
130	10,700	11,400	12,000	12,500
135	9,700	10,300	10,900	11,300
140	8,700	9,300	9,900	10,300
145	7,900	8,400	8,900	9,300
150	7,100	7,600	8,100	8,400
155	6,300	6,800	7,200	7,500
160	5,600	6,100	6,500	6,700
165	5,000	5,400	5,800	6,000
170	4,300	4,700	5,100	5,300
175	3,800	4,100	4,500	4,600
180	3,200	3,600	3,900	4,000
185	2,700	3,100	3,300	3,400
190	2,300	2,600	2,800	2,800
195		2,100	2,300	
Min Angle	39.0	39.0	39.0	39.0
Max Rad.	193.0	196.0	198.0	198.0
Capacity	0	0	0	0

1051040



PORTLAND OFFICE: 503.283.3111
 SEATTLE OFFICE: 206.784.1054
WWW.NESSCAMPBELL.COM

Rated Lifting Capacities in Pounds

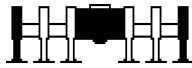

Full

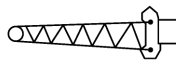

40ft Offset Fly



71,500 lbs



Radius (ft)	Boom Length (ft)											
	Fly Offset											
	44.3				58.9				89.1			
	2°	15°	30°	45°	2°	15°	30°	45°	2°	15°	30°	45°
10	34,700				34,700							
12	34,700				34,700							
15	34,700	34,700			34,700				34,600			
20	34,700	32,000			34,700	34,200			34,600			
25	33,900	28,800	24,900		34,700	31,100	25,900		34,600	34,600		
30	30,200	26,200	22,900	20,200	34,200	28,400	24,100		34,600	32,100	25,900	
35	27,200	24,000	20,700	19,000	31,000	26,200	21,900	19,800	34,600	29,900	24,500	
40	24,800	21,400	19,400	18,000	28,300	24,300	20,700	18,800	34,600	28,000	23,300	20,000
45	21,900	19,900	18,200	17,200	26,000	22,000	19,600	18,000	32,200	26,300	21,700	19,300
50	20,200	18,600	17,300	16,400	24,000	20,600	18,600	17,300	29,900	24,900	20,700	18,600
55	18,800	17,500	16,400	15,800	21,600	19,500	17,800	16,700	27,900	23,600	19,900	18,000
60	17,500	16,500	15,700	15,300	20,200	18,400	17,000	16,100	26,200	21,800	19,100	17,500
65	16,400	15,600	15,000	14,900	19,000	17,500	16,300	15,700	24,600	20,800	18,400	17,000
70	15,400	14,900	14,600		17,900	16,700	15,700	15,300	23,300	19,900	17,800	16,600
75	14,500	14,300			16,900	15,900	15,200	15,000	21,400	19,000	17,200	16,200
80					16,000	15,300	14,800		20,400	18,300	16,700	15,800
85					15,200	14,700	14,500		19,400	17,600	16,200	15,500
90					14,500				18,500	16,900	15,800	15,300
95									17,700	16,400	15,400	15,100
100									17,000	15,800	15,100	14,900
105									16,300	15,300	14,800	
110									15,700	14,900	14,600	
115									15,100	14,600		
120									14,500			
Min Angle	0.0	0.0	0.0	0.0	0.0	0.0	0.0	0.0	0.0	0.0	0.0	0.0
Max Rad. Capacity	75.9	75.8	74.5	71.9	90.5	90.4	88.8	85.9	120.7	120.5	118.6	115.2
Capacity	11,200	11,400	12,100	13,600	6,600	6,700	7,000	7,700	4,900	5,000	5,200	5,700

1051050



PORTLAND OFFICE: 503.283.3111
 SEATTLE OFFICE: 206.784.1054
WWW.NESSCAMPBELL.COM

Rated Lifting Capacities in Pounds

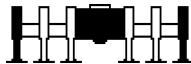

Full

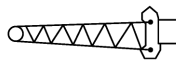

40ft Offset Fly



71,500 lbs



Radius (ft)	Boom Length (ft)											
	Fly Offset											
	120.3				152.4				169.0			
	2°	15°	30°	45°	2°	15°	30°	45°	2°	15°	30°	45°
25	34,500											
30	34,500				31,300							
35	34,500	32,800			31,300							
40	34,500	30,900			31,300				29,200			
45	34,500	29,300	23,700		31,300	31,200			29,200			
50	34,500	27,800	22,800	19,500	31,300	30,300	24,000		29,200	29,100		
55	33,100	26,500	21,500	19,000	31,300	28,900	23,200		29,200	29,100	23,800	
60	31,200	25,300	20,800	18,500	31,300	27,700	22,000	19,300	29,200	28,800	23,100	
65	29,300	24,200	20,100	18,000	29,700	26,600	21,400	18,800	29,200	27,700	22,000	19,200
70	27,300	23,200	19,500	17,600	27,600	25,600	20,800	18,400	29,200	26,700	21,400	18,800
75	25,500	21,700	18,900	17,200	25,700	24,600	20,200	18,100	27,500	25,700	20,800	18,400
80	23,800	20,900	18,300	16,900	24,000	23,700	19,700	17,700	25,800	24,800	20,300	18,100
85	22,500	20,200	17,900	16,500	22,500	22,500	19,200	17,400	24,200	24,000	19,800	17,800
90	21,100	19,500	17,400	16,200	21,100	21,200	18,800	17,100	22,800	22,600	19,400	17,400
95	19,900	18,800	17,000	16,000	19,800	19,900	18,300	16,800	21,400	21,300	18,900	17,200
100	18,800	18,200	16,600	15,700	18,700	18,700	17,900	16,500	19,600	20,100	18,500	16,900
105	17,800	17,700	16,200	15,500	17,600	17,700	17,500	16,300	17,800	18,600	18,100	16,600
110	16,800	16,800	15,800	15,300	16,600	16,700	16,800	16,000	16,400	16,900	17,700	16,400
115	15,900	15,900	15,600	15,100	15,600	15,700	15,800	15,800	14,900	15,700	16,400	16,200
120	15,100	15,100	15,100	15,000	14,700	14,900	15,000	15,100	13,600	14,300	14,900	15,400
125	14,400	14,400	14,400	14,400	13,500	14,000	14,200	14,200	12,300	13,000	13,600	14,000
130	13,700	13,700	13,700		12,300	12,800	13,300	13,500	11,200	11,800	12,400	12,700
135	12,900	13,000	13,000		11,300	11,800	12,200	12,400	10,200	10,700	11,200	11,600
140	11,900	12,100	12,200		10,400	10,800	11,100	11,300	9,200	9,800	10,200	10,500
145	11,100	11,200			9,500	9,900	10,200	10,300	8,400	8,800	9,300	9,500
150	10,300	10,300			8,700	9,000	9,300	9,400	7,600	8,000	8,400	8,600
155					7,900	8,200	8,500		6,800	7,200	7,500	7,700
160					7,200	7,500	7,700		6,100	6,500	6,800	6,900
165					6,600	6,800	6,900		5,500	5,800	6,000	
170					6,000	6,200	6,300		4,900	5,100	5,400	
175					5,400	5,600			4,300	4,500	4,700	
180									3,800	4,000	4,100	
185									3,300	3,400	3,500	
190									2,800	2,900		
195									2,400	2,500		
Min Angle	0.0	0.0	0.0	0.0	16.5	18.0	16.5	21.0	8.5	7.0	18.5	22.5
Max Rad.	151.9	151.6	149.6	145.9	180.0	180.0	180.0	175.0	200.0	199.9	195.0	190.0
Capacity	3,200	3,200	3,400	3,700	0	0	0	0	0	0	0	0

1051050



PORTLAND OFFICE: 503.283.3111
 SEATTLE OFFICE: 206.784.1054
WWW.NESSCAMPBELL.COM

Rated Lifting Capacities in Pounds

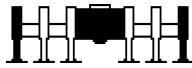

Full

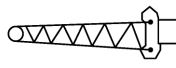

40ft Offset Fly



71,500 lbs



Radius (ft)	Boom Length (ft)			
	Fly Offset			
	185.5			
	2°	15°	30°	45°
40	20,200			
45	20,200			
50	20,200	20,100		
55	20,200	20,100		
60	20,200	20,100	19,900	
65	20,200	20,100	19,900	
70	20,200	20,100	19,900	19,100
75	20,200	20,100	19,900	18,700
80	20,200	20,100	19,900	18,400
85	20,200	20,100	19,900	18,100
90	20,200	20,100	19,900	17,800
95	20,200	20,100	19,500	17,500
100	18,600	19,600	19,100	17,200
105	16,900	17,700	18,600	17,000
110	15,400	16,300	17,000	16,700
115	13,900	14,800	15,600	16,100
120	12,600	13,400	14,100	14,600
125	11,400	12,100	12,800	13,200
130	10,300	10,900	11,600	12,000
135	9,200	9,900	10,400	10,800
140	8,300	8,900	9,400	9,800
145	7,400	8,000	8,500	8,800
150	6,600	7,100	7,600	7,800
155	5,900	6,300	6,700	7,000
160	5,200	5,600	6,000	6,200
165	4,500	4,900	5,300	5,400
170	3,900	4,300	4,600	4,700
175	3,300	3,700	4,000	4,000
180	2,800	3,100	3,400	
185	2,300	2,600	2,800	
190		2,100	2,200	
Min Angle	34.5	35.0	35.0	34.5
Max Rad.	188.0	191.0	192.0	192.0
Capacity	0	0	0	0

1051050



PORTLAND OFFICE: 503.283.3111
 SEATTLE OFFICE: 206.784.1054
WWW.NESSCAMPBELL.COM

Rated Lifting Capacities in Pounds

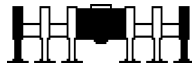

Full

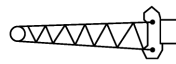

40ft Offset Fly

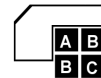

71,500 lbs



Radius (ft)	Boom Length (ft)											
	Fly Offset											
	44.3				73.5				103.8			
	2°	15°	30°	45°	2°	15°	30°	45°	2°	15°	30°	45°
10	34,700											
12	34,700				34,600							
15	34,700	34,700			34,600							
20	34,700	32,000			34,600	34,600			34,500			
25	33,900	28,800	24,900		34,600	32,900			34,500			
30	30,200	26,200	22,900	20,200	34,600	30,300	25,100		34,500	33,500		
35	27,200	24,000	20,700	19,000	34,500	28,100	23,600	20,300	34,500	31,400	25,200	
40	24,800	21,400	19,400	18,000	31,600	26,200	21,700	19,500	34,500	29,500	24,000	20,400
45	21,900	19,900	18,200	17,200	29,100	24,600	20,700	18,700	34,500	27,800	23,000	19,700
50	20,200	18,600	17,300	16,400	27,000	23,100	19,700	18,000	32,500	26,300	21,500	19,100
55	18,800	17,500	16,400	15,800	25,100	21,200	18,900	17,400	30,400	25,000	20,700	18,500
60	17,500	16,500	15,700	15,300	23,500	20,100	18,100	16,900	28,600	23,800	20,000	18,000
65	16,400	15,600	15,000	14,900	21,400	19,200	17,400	16,400	26,700	22,700	19,300	17,500
70	15,400	14,900	14,600		20,200	18,300	16,800	15,900	24,800	21,200	18,600	17,100
75	14,500	14,300			19,200	17,500	16,200	15,600	23,200	20,400	18,000	16,700
80					18,200	16,800	15,700	15,300	22,000	19,600	17,500	16,400
85					17,300	16,100	15,300	15,000	20,600	18,800	17,000	16,000
90					16,500	15,500	14,900		19,400	18,200	16,600	15,700
95					15,700	15,000	14,600		18,100	17,600	16,200	15,500
100					15,100	14,600			17,000	17,000	15,800	15,300
105					9,500				16,000	16,000	15,400	15,100
110									15,100	15,100	15,100	14,900
115									14,300	14,300	14,300	
120									13,500	13,500	13,500	
125									12,800	12,800	12,800	
130									12,200	12,200		
135									8,800			
Min Angle	0.0	0.0	0.0	0.0	0.0	0.0	0.0	0.0	0.0	0.0	0.0	0.0
Max Rad.	75.9	75.8	74.5	71.9	105.1	104.9	103.2	100.0	135.3	135.1	133.1	129.6
Capacity	11,200	11,400	12,100	13,600	3,700	3,700	3,900	4,200	2,600	2,600	2,700	2,900

1051060



PORTLAND OFFICE: 503.283.3111
 SEATTLE OFFICE: 206.784.1054
WWW.NESSCAMPBELL.COM

Rated Lifting Capacities in Pounds

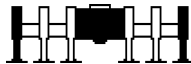

Full

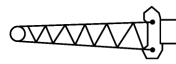

40ft Offset Fly



71,500 lbs



Radius (ft)	Boom Length (ft)											
	Fly Offset											
	119.4				135.4				152.0			
	2°	15°	30°	45°	2°	15°	30°	45°	2°	15°	30°	45°
25	33,900				34,400							
30	33,900				34,400				33,800			
35	33,900	32,700			34,400	33,900			33,800			
40	33,900	30,900	24,700		34,400	32,100			33,800	33,300		
45	33,900	29,200	23,700	20,100	34,400	30,500	24,300		33,800	31,700	24,900	
50	33,900	27,700	22,800	19,500	34,400	29,000	23,400	19,900	33,800	30,200	24,000	20,200
55	33,000	26,400	21,500	19,000	34,400	27,700	22,100	19,400	33,800	28,900	23,200	19,700
60	31,000	25,200	20,700	18,500	33,400	26,500	21,400	18,900	33,800	27,700	22,000	19,200
65	28,900	24,100	20,000	18,000	31,200	25,400	20,700	18,400	33,100	26,600	21,400	18,800
70	27,000	23,100	19,400	17,600	29,200	24,300	20,100	18,000	31,100	25,500	20,800	18,400
75	25,300	21,600	18,800	17,200	27,400	23,400	19,600	17,600	29,300	24,600	20,200	18,000
80	23,800	20,800	18,300	16,900	25,800	22,000	19,000	17,300	27,700	23,700	19,700	17,700
85	22,500	20,100	17,800	16,500	24,400	21,300	18,500	17,000	26,200	22,900	19,200	17,400
90	21,300	19,400	17,300	16,200	23,100	20,600	18,100	16,700	24,800	21,700	18,700	17,100
95	20,100	18,800	16,900	15,900	21,900	19,900	17,600	16,400	22,900	21,000	18,300	16,800
100	19,100	18,200	16,500	15,700	20,800	19,300	17,200	16,100	20,900	20,400	17,900	16,500
105	18,000	17,600	16,100	15,500	19,800	18,700	16,800	15,900	19,000	19,800	17,500	16,300
110	17,000	16,800	15,800	15,300	18,800	18,200	16,500	15,600	17,400	18,100	17,100	16,000
115	16,100	16,000	15,500	15,100	17,300	17,600	16,200	15,500	16,100	16,800	16,800	15,800
120	15,300	15,200	15,100	15,000	16,100	16,600	15,800	15,300	14,800	15,400	15,900	15,600
125	14,500	14,400	14,400	14,400	14,900	15,300	15,600	15,100	13,500	14,100	14,600	14,900
130	13,800	13,800	13,700		13,700	14,200	14,500	14,700	12,400	12,900	13,400	13,600
135	13,200	13,100	13,100		12,700	13,100	13,400	13,500	11,400	11,800	12,200	12,500
140	12,600	12,500	12,500		11,800	12,100	12,300		10,400	10,800	11,200	11,400
145	11,800	12,000			10,900	11,200	11,400		9,500	9,900	10,200	10,400
150					10,100	10,300	10,400		8,700	9,100	9,300	9,400
155					9,300	9,500	9,600		8,000	8,300	8,500	
160					8,600	8,800			7,300	7,600	7,700	
165									6,600	6,900	7,000	
170									6,000	6,200	6,300	
175									5,500	5,600		
Min Angle	11.5	13.0	0.0	0.0	13.0	15.0	23.0	3.5	15.5	17.0	15.0	20.0
Max Rad.	150.0	150.0	148.6	144.9	165.0	165.0	160.0	158.9	180.0	180.0	180.0	175.0
Capacity	0	0	2,000	2,200	0	0	0	0	0	0	0	0

1051060



PORTLAND OFFICE: 503.283.3111
 SEATTLE OFFICE: 206.784.1054
WWW.NESSCAMPBELL.COM

Rated Lifting Capacities in Pounds

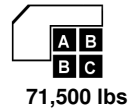
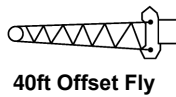
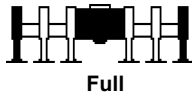

Radius (ft)	Boom Length (ft)			
	Fly Offset			
	168.5			
	2°	15°	30°	45°
35	29,200			
40	29,200			
45	29,200	29,000		
50	29,200	29,000		
55	29,200	29,000	23,800	
60	29,200	28,800	23,100	19,600
65	29,200	27,700	22,000	19,200
70	29,200	26,600	21,400	18,800
75	29,200	25,700	20,800	18,400
80	29,100	24,800	20,300	18,100
85	26,700	24,000	19,800	17,700
90	24,100	23,200	19,300	17,400
95	21,700	22,000	18,900	17,100
100	19,700	20,600	18,500	16,900
105	17,800	18,700	18,100	16,600
110	16,500	17,000	17,700	16,400
115	15,000	15,700	16,400	16,200
120	13,600	14,300	15,000	15,400
125	12,400	13,000	13,600	14,000
130	11,300	11,900	12,400	12,800
135	10,200	10,800	11,300	11,600
140	9,300	9,800	10,300	10,500
145	8,400	8,900	9,300	9,500
150	7,600	8,000	8,400	8,600
155	6,900	7,300	7,600	7,700
160	6,200	6,500	6,800	6,900
165	5,500	5,800	6,100	
170	4,900	5,200	5,400	
175	4,300	4,600	4,800	
180	3,800	4,000	4,200	
185	3,300	3,500	3,600	
190	2,900	3,000		
195	2,400			
Min Angle	15.0	18.5	17.5	21.5
Max Rad.	195.9	195.0	195.0	190.0
Capacity	0	0	0	0

1051060



PORTLAND OFFICE: 503.283.3111
 SEATTLE OFFICE: 206.784.1054
WWW.NESSCAMPBELL.COM

Rated Lifting Capacities in Pounds

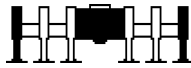

Full

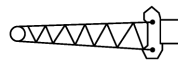

40ft Hydraulic Offset Fly



71,500 lbs



Radius (ft)	Boom Length (ft)											
	Fly Offset											
	44.3			73.5			103.8			134.9		
	2°-15°	15°-30°	30°-45°	2°-15°	15°-30°	30°-45°	2°-15°	15°-30°	30°-45°	2°-15°	15°-30°	30°-45°
10	34,700											
12	34,700	34,700		34,600								
15	34,700	34,700		34,600								
20	32,000	27,100	27,100	34,600	34,600		34,500					
25	28,800	24,900	24,900	32,900	32,900		34,500	34,500		29,700		
30	26,200	22,900	20,200	30,300	25,100	25,100	33,500	33,500		29,700		
35	24,000	20,700	19,000	28,100	23,600	20,300	31,400	25,200	25,200	29,500	29,500	
40	21,400	19,400	18,000	26,200	21,700	19,500	29,500	24,000	20,400	29,500	25,300	25,300
45	19,900	18,200	17,200	24,600	20,700	18,700	27,800	23,000	19,700	29,500	24,300	20,400
50	18,600	17,300	16,400	23,100	19,700	18,000	26,300	21,500	19,100	29,000	23,400	19,900
55	17,500	16,400	15,800	21,200	18,900	17,400	25,000	20,700	18,500	27,700	22,100	19,300
60	16,500	15,700	15,300	20,100	18,100	16,900	23,800	20,000	18,000	26,400	21,400	18,900
65	15,600	15,000	14,900	19,200	17,400	16,400	22,700	19,300	17,500	25,300	20,700	18,400
70	14,900	14,600	14,600	18,300	16,800	15,900	21,200	18,600	17,100	24,300	20,100	18,000
75	14,300	14,300		17,500	16,200	15,600	20,400	18,000	16,700	23,400	19,600	17,600
80				16,800	15,700	15,300	19,600	17,500	16,400	22,000	19,000	17,300
85				16,100	15,300	15,000	18,800	17,000	16,000	21,200	18,500	17,000
90				15,500	14,900	14,900	18,200	16,600	15,700	19,900	18,000	16,600
95				15,000	14,600	14,600	17,600	16,200	15,500	18,800	17,600	16,400
100				14,600	14,500		17,000	15,800	15,300	17,700	17,200	16,100
105				9,500			16,000	15,400	15,100	16,700	16,700	15,800
110							15,100	15,100	14,900	15,800	15,800	15,600
115							14,300	14,300	14,300	15,000	15,000	15,000
120							13,500	13,500	13,500	14,200	14,200	14,200
125							12,800	12,800	12,800	13,500	13,500	13,500
130							12,200	12,200		12,800	12,800	12,800
135							8,800			12,100	12,200	12,200
140										11,500	11,600	11,600
145										11,000	11,000	11,100
150										10,500	10,500	10,500
155										9,800	10,000	9,900
160										9,100		
Min Angle	0.0	0.0	0.0	0.0	0.0	0.0	0.0	0.0	0.0	13.0	23.0	4.0
Max Rad.	75.9	75.8	74.5	105.1	104.9	103.2	135.3	135.1	133.1	165.0	160.0	158.4
Capacity	11,200	11,400	12,100	3,700	3,700	3,900	2,600	2,600	2,700	0	0	0

1052040



PORTLAND OFFICE: 503.283.3111
 SEATTLE OFFICE: 206.784.1054
WWW.NESSCAMPBELL.COM

Rated Lifting Capacities in Pounds

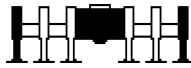

Full

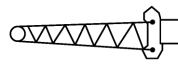

40ft Hydraulic Offset Fly



71,500 lbs



Radius (ft)	Boom Length (ft)								
	Fly Offset								
	167.1			183.6			200.1		
	2°-15°	15°-30°	30°-45°	2°-15°	15°-30°	30°-45°	2°-15°	15°-30°	30°-45°
30	19,800								
35	19,800			18,600					
40	19,700	19,700		18,400	18,400		16,100		
45	19,700	19,500	19,500	18,400	18,400		16,000	16,000	
50	19,700	19,500	19,500	18,400	18,400		16,000	16,000	
55	19,700	19,500	19,200	18,400	18,300	18,300	16,000	15,800	15,800
60	19,700	19,500	19,200	18,400	18,300	18,000	16,000	15,800	15,600
65	19,700	19,500	19,100	18,400	18,300	18,000	16,000	15,800	15,600
70	19,700	19,500	18,700	18,400	18,300	18,000	16,000	15,800	15,600
75	19,700	19,500	18,400	18,400	18,300	18,000	16,000	15,800	15,600
80	19,700	19,500	18,000	18,400	18,300	18,000	16,000	15,800	15,600
85	19,700	19,500	17,700	18,400	18,300	18,000	16,000	15,800	15,600
90	19,700	19,300	17,400	18,400	18,300	17,700	16,000	15,800	15,600
95	19,300	18,900	17,100	18,400	18,300	17,500	16,000	15,800	15,600
100	18,200	18,300	16,900	18,400	18,300	17,200	16,000	15,800	15,600
105	17,100	17,200	16,600	18,200	18,300	16,900	16,000	15,800	15,600
110	16,100	16,200	16,300	16,900	17,300	16,700	15,900	15,800	15,600
115	15,200	15,300	15,400	15,400	16,100	16,500	14,400	15,200	15,600
120	14,300	14,500	14,600	14,000	14,700	15,400	13,100	13,800	14,600
125	13,500	13,700	13,800	12,800	13,400	14,000	11,800	12,600	13,200
130	12,700	12,900	13,100	11,700	12,300	12,800	10,700	11,400	12,000
135	11,700	12,200	12,400	10,600	11,200	11,700	9,700	10,300	10,900
140	10,700	11,200	11,600	9,700	10,200	10,700	8,700	9,300	9,900
145	9,900	10,300	10,700	8,800	9,300	9,700	7,900	8,400	8,900
150	9,100	9,400	9,800	8,000	8,400	8,900	7,100	7,600	8,100
155	8,300	8,700	8,900	7,200	7,700	8,000	6,300	6,800	7,200
160	7,600	7,900	8,200	6,500	6,900	7,300	5,600	6,100	6,500
165	6,900	7,200	7,500	5,900	6,200	6,500	5,000	5,400	5,800
170	6,300	6,600	6,800	5,300	5,600	5,900	4,300	4,700	5,100
175	5,800	6,000	6,100	4,700	5,000	5,200	3,800	4,100	4,500
180	5,200	5,400	5,500	4,200	4,400	4,600	3,200	3,600	3,900
185	4,700	4,900	4,800	3,700	3,900	4,100	2,700	3,100	3,300
190	4,300	4,400		3,200	3,400	3,500	2,300	2,600	2,800
195				2,700	2,900	3,000		2,100	2,300
200				2,300	2,500	2,400			
205					2,100				
Min Angle	16.0	15.5	20.0	23.5	23.0	22.0	39.0	39.0	39.0
Max Rad. Capacity	195.0	195.0	190.0	203.8	206.0	204.0	193.0	196.0	198.0
	0	0	0	0	0	0	0	0	0

1052040



PORTLAND OFFICE: 503.283.3111
 SEATTLE OFFICE: 206.784.1054
WWW.NESSCAMPBELL.COM

Rated Lifting Capacities in Pounds

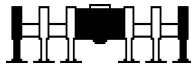

Full

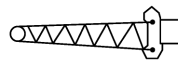

40ft Hydraulic Offset Fly



71,500 lbs



Radius (ft)	Boom Length (ft)											
	Fly Offset											
	44.3			58.9			89.1			120.3		
	2°-15°	15°-30°	30°-45°	2°-15°	15°-30°	30°-45°	2°-15°	15°-30°	30°-45°	2°-15°	15°-30°	30°-45°
10	34,700			34,700								
12	34,700	34,700		34,700								
15	34,700	34,700		34,700	34,700		34,600					
20	32,000	27,100	27,100	34,200	34,200		34,600	34,600				
25	28,800	24,900	24,900	31,100	25,900	25,900	34,600	34,600		34,500		
30	26,200	22,900	20,200	28,400	24,100	20,800	32,100	25,900	25,900	34,500	34,500	
35	24,000	20,700	19,000	26,200	21,900	19,800	29,900	24,500	20,800	32,800	25,800	25,800
40	21,400	19,400	18,000	24,300	20,700	18,800	28,000	23,300	20,000	30,900	24,700	24,700
45	19,900	18,200	17,200	22,000	19,600	18,000	26,300	21,700	19,300	29,300	23,700	20,100
50	18,600	17,300	16,400	20,600	18,600	17,300	24,900	20,700	18,600	27,800	22,800	19,500
55	17,500	16,400	15,800	19,500	17,800	16,700	23,600	19,900	18,000	26,500	21,500	19,000
60	16,500	15,700	15,300	18,400	17,000	16,100	21,800	19,100	17,500	25,300	20,800	18,500
65	15,600	15,000	14,900	17,500	16,300	15,700	20,800	18,400	17,000	24,200	20,100	18,000
70	14,900	14,600	14,600	16,700	15,700	15,300	19,900	17,800	16,600	23,200	19,500	17,600
75	14,300	14,300		15,900	15,200	15,000	19,000	17,200	16,200	21,700	18,900	17,200
80				15,300	14,800	14,800	18,300	16,700	15,800	20,900	18,300	16,900
85				14,700	14,500	14,500	17,600	16,200	15,500	20,200	17,900	16,500
90				14,300			16,900	15,800	15,300	19,500	17,400	16,200
95							16,400	15,400	15,100	18,800	17,000	16,000
100							15,800	15,100	14,900	18,200	16,600	15,700
105							15,300	14,800	14,800	17,700	16,200	15,500
110							14,900	14,600	14,600	16,800	15,800	15,300
115							14,600	14,500		15,900	15,600	15,100
120							14,400			15,100	15,100	15,000
125										14,400	14,400	14,400
130										13,700	13,700	13,700
135										12,900	13,000	13,000
140										11,900	12,100	12,100
145										11,100	11,200	
150										10,300	10,300	
Min Angle	0.0	0.0	0.0	0.0	0.0	0.0	0.0	0.0	0.0	0.0	0.0	0.0
Max Rad. Capacity	11,200	11,400	12,100	6,600	6,700	7,000	4,900	5,000	5,200	3,200	3,200	3,400

1052050



PORTLAND OFFICE: 503.283.3111
 SEATTLE OFFICE: 206.784.1054
WWW.NESSCAMPBELL.COM

Rated Lifting Capacities in Pounds

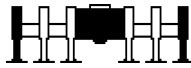

Full

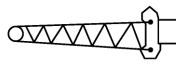

40ft Hydraulic Offset Fly



71,500 lbs



Radius (ft)	Boom Length (ft)								
	Fly Offset								
	152.4			169.0			185.5		
	2°-15°	15°-30°	30°-45°	2°-15°	15°-30°	30°-45°	2°-15°	15°-30°	30°-45°
30	31,300								
35	31,000	31,000							
40	31,000	31,000		29,200			20,200		
45	31,000	24,900	24,900	29,000	29,000		20,100	20,100	
50	30,300	24,000	20,200	29,000	24,500	24,500	20,100	20,100	
55	28,900	23,200	19,700	29,000	23,800	23,800	20,100	19,800	19,800
60	27,700	22,000	19,300	28,800	23,100	19,600	20,100	19,800	19,800
65	26,600	21,400	18,800	27,700	22,000	19,200	20,100	19,800	19,500
70	25,600	20,800	18,400	26,700	21,400	18,800	20,100	19,800	19,100
75	24,600	20,200	18,100	25,700	20,800	18,400	20,100	19,800	18,700
80	23,700	19,700	17,700	24,800	20,300	18,100	20,100	19,800	18,400
85	22,500	19,200	17,400	24,000	19,800	17,800	20,100	19,800	18,100
90	21,100	18,800	17,100	22,600	19,400	17,400	20,100	19,800	17,800
95	19,800	18,300	16,800	21,300	18,900	17,200	20,100	19,500	17,500
100	18,700	17,900	16,500	19,600	18,500	16,900	18,600	19,100	17,200
105	17,600	17,500	16,300	17,800	18,100	16,600	16,900	17,700	17,000
110	16,600	16,700	16,000	16,400	16,900	16,400	15,400	16,300	16,700
115	15,600	15,700	15,800	14,900	15,700	16,200	13,900	14,800	15,600
120	14,700	14,900	15,000	13,600	14,300	14,900	12,600	13,400	14,100
125	13,500	14,000	14,200	12,300	13,000	13,600	11,400	12,100	12,800
130	12,300	12,800	13,300	11,200	11,800	12,400	10,300	10,900	11,600
135	11,300	11,800	12,200	10,200	10,700	11,200	9,200	9,900	10,400
140	10,400	10,800	11,100	9,200	9,800	10,200	8,300	8,900	9,400
145	9,500	9,900	10,200	8,400	8,800	9,300	7,400	8,000	8,500
150	8,700	9,000	9,300	7,600	8,000	8,400	6,600	7,100	7,600
155	7,900	8,200	8,500	6,800	7,200	7,500	5,900	6,300	6,700
160	7,200	7,500	7,700	6,100	6,500	6,800	5,200	5,600	6,000
165	6,600	6,800	6,900	5,500	5,800	6,000	4,500	4,900	5,300
170	6,000	6,200	6,100	4,900	5,100	5,400	3,900	4,300	4,600
175	5,400	5,600		4,300	4,500	4,700	3,300	3,700	4,000
180				3,800	4,000	4,100	2,800	3,100	3,400
185				3,300	3,400	3,400	2,300	2,600	2,800
190				2,800	2,900			2,100	2,200
195				2,400					
Min Angle	16.5	16.5	21.0	7.0	18.5	22.5	34.5	35.0	34.5
Max Rad. Capacity	180.0	180.0	175.0	199.9	195.0	190.0	188.0	191.0	192.0
	0	0	0	0	0	0	0	0	0

1052050



PORTLAND OFFICE: 503.283.3111
 SEATTLE OFFICE: 206.784.1054
WWW.NESSCAMPBELL.COM

Rated Lifting Capacities in Pounds

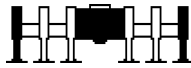

Full

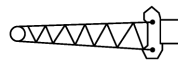

40ft Hydraulic Offset Fly



71,500 lbs



Radius (ft)	Boom Length (ft)											
	Fly Offset											
	44.3			73.5			103.8			119.4		
	2°-15°	15°-30°	30°-45°	2°-15°	15°-30°	30°-45°	2°-15°	15°-30°	30°-45°	2°-15°	15°-30°	30°-45°
10	34,700											
12	34,700	34,700		34,600								
15	34,700	34,700		34,600								
20	32,000	27,100	27,100	34,600	34,600		34,500					
25	28,800	24,900	24,900	32,900	32,900		34,500	34,500		33,900		
30	26,200	22,900	20,200	30,300	25,100	25,100	33,500	33,500		33,600	33,600	
35	24,000	20,700	19,000	28,100	23,600	20,300	31,400	25,200	25,200	32,700	25,800	25,800
40	21,400	19,400	18,000	26,200	21,700	19,500	29,500	24,000	20,400	30,900	24,700	20,700
45	19,900	18,200	17,200	24,600	20,700	18,700	27,800	23,000	19,700	29,200	23,700	20,100
50	18,600	17,300	16,400	23,100	19,700	18,000	26,300	21,500	19,100	27,700	22,800	19,500
55	17,500	16,400	15,800	21,200	18,900	17,400	25,000	20,700	18,500	26,400	21,500	19,000
60	16,500	15,700	15,300	20,100	18,100	16,900	23,800	20,000	18,000	25,200	20,700	18,500
65	15,600	15,000	14,900	19,200	17,400	16,400	22,700	19,300	17,500	24,100	20,000	18,000
70	14,900	14,600	14,600	18,300	16,800	15,900	21,200	18,600	17,100	23,100	19,400	17,600
75	14,300	14,300		17,500	16,200	15,600	20,400	18,000	16,700	21,600	18,800	17,200
80				16,800	15,700	15,300	19,600	17,500	16,400	20,800	18,300	16,900
85				16,100	15,300	15,000	18,800	17,000	16,000	20,100	17,800	16,500
90				15,500	14,900	14,900	18,200	16,600	15,700	19,400	17,300	16,200
95				15,000	14,600	14,600	17,600	16,200	15,500	18,800	16,900	15,900
100				14,600	14,500		17,000	15,800	15,300	18,200	16,500	15,700
105				9,500			16,000	15,400	15,100	17,600	16,100	15,500
110							15,100	15,100	14,900	16,800	15,800	15,300
115							14,300	14,300	14,300	16,000	15,500	15,100
120							13,500	13,500	13,500	15,200	15,100	15,000
125							12,800	12,800	12,800	14,400	14,400	14,400
130							12,200	12,200		13,800	13,700	13,700
135							8,800			13,100	13,100	13,100
140										12,500	12,500	12,500
145										11,800	12,000	
Min Angle	0.0	0.0	0.0	0.0	0.0	0.0	0.0	0.0	0.0	11.5	13.0	0.0
Max Rad.	75.9	75.8	74.5	105.1	104.9	103.2	135.3	135.1	133.1	150.0	150.0	148.6
Capacity	11,200	11,400	12,100	3,700	3,700	3,900	2,600	2,600	2,700	0	0	2,000

1052060



PORTLAND OFFICE: 503.283.3111
 SEATTLE OFFICE: 206.784.1054
WWW.NESSCAMPBELL.COM

Rated Lifting Capacities in Pounds

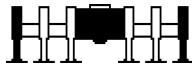

Full

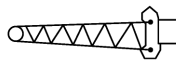

40ft Hydraulic Offset Fly



71,500 lbs



Radius (ft)	Boom Length (ft)								
	Fly Offset								
	135.4			152.0			168.5		
	2°-15°	15°-30°	30°-45°	2°-15°	15°-30°	30°-45°	2°-15°	15°-30°	30°-45°
25	34,400								
30	34,400			33,800					
35	33,900	33,900		33,500	33,500		29,200		
40	32,100	25,300	25,300	33,300	33,300		28,900	28,900	
45	30,500	24,300	20,400	31,700	24,900	24,900	28,900	28,900	
50	29,000	23,400	19,900	30,200	24,000	20,200	28,900	24,500	24,500
55	27,700	22,100	19,400	28,900	23,200	19,700	28,900	23,800	20,000
60	26,500	21,400	18,900	27,700	22,000	19,200	28,800	23,100	19,600
65	25,400	20,700	18,400	26,600	21,400	18,800	27,700	22,000	19,200
70	24,300	20,100	18,000	25,500	20,800	18,400	26,600	21,400	18,800
75	23,400	19,600	17,600	24,600	20,200	18,000	25,700	20,800	18,400
80	22,000	19,000	17,300	23,700	19,700	17,700	24,800	20,300	18,100
85	21,300	18,500	17,000	22,900	19,200	17,400	24,000	19,800	17,700
90	20,600	18,100	16,700	21,700	18,700	17,100	23,200	19,300	17,400
95	19,900	17,600	16,400	21,000	18,300	16,800	21,700	18,900	17,100
100	19,300	17,200	16,100	20,400	17,900	16,500	19,700	18,500	16,900
105	18,700	16,800	15,900	19,000	17,500	16,300	17,800	18,100	16,600
110	18,200	16,500	15,600	17,400	17,100	16,000	16,500	17,000	16,400
115	17,300	16,200	15,500	16,100	16,800	15,800	15,000	15,700	16,200
120	16,100	15,800	15,300	14,800	15,400	15,600	13,600	14,300	15,000
125	14,900	15,300	15,100	13,500	14,100	14,600	12,400	13,000	13,600
130	13,700	14,200	14,500	12,400	12,900	13,400	11,300	11,900	12,400
135	12,700	13,100	13,400	11,400	11,800	12,200	10,200	10,800	11,300
140	11,800	12,100	12,300	10,400	10,800	11,200	9,300	9,800	10,300
145	10,900	11,200	11,400	9,500	9,900	10,200	8,400	8,900	9,300
150	10,100	10,300	10,400	8,700	9,100	9,300	7,600	8,000	8,400
155	9,300	9,500	9,500	8,000	8,300	8,500	6,900	7,300	7,600
160	8,600			7,300	7,600	7,700	6,200	6,500	6,800
165				6,600	6,900	6,900	5,500	5,800	6,100
170				6,000	6,200	6,200	4,900	5,200	5,400
175				5,500	5,600		4,300	4,600	4,800
180							3,800	4,000	4,100
185							3,300	3,500	3,500
190							2,900	3,000	
Min Angle	13.0	23.0	3.5	15.5	15.0	20.0	18.5	17.5	21.5
Max Rad. Capacity	165.0	160.0	158.9	180.0	180.0	175.0	195.0	195.0	190.0
	0	0	0	0	0	0	0	0	0

1052060



PORTLAND OFFICE: 503.283.3111
 SEATTLE OFFICE: 206.784.1054
WWW.NESSCAMPBELL.COM

Rated Lifting Capacities in Pounds

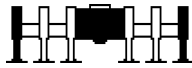

Full

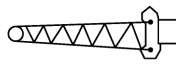

67ft Offset Fly



71,500 lbs



Radius (ft)	Boom Length (ft)											
	Fly Offset											
	44.3				73.5				103.8			
	2°	15°	30°	45°	2°	15°	30°	45°	2°	15°	30°	45°
15	30,000											
20	27,800				27,500							
25	24,600	19,800			27,500				18,200			
30	21,100	18,100			21,400				18,200			
35	19,100	16,600			21,400	18,500			18,200			
40	17,400	15,400	13,700		21,100	17,300			18,200	18,100		
45	16,000	14,300	12,800		19,500	16,200	13,700		18,200	17,700		
50	14,800	13,300	12,100		18,100	15,300	13,100		18,200	16,800		
55	13,800	12,500	11,400	10,600	16,900	14,400	12,400		18,200	15,900	13,200	
60	12,800	11,700	10,800	10,100	15,800	13,600	11,900	10,700	18,200	15,200	12,700	
65	12,000	11,100	10,300	9,700	14,900	12,900	11,400	10,300	17,500	14,500	12,200	10,800
70	11,200	10,500	9,800	9,300	14,000	12,300	10,900	10,000	16,600	13,800	11,800	10,500
75	10,600	9,900	9,300	8,900	13,200	11,700	10,500	9,700	15,700	13,200	11,400	10,200
80	10,000	9,400	8,900	8,600	12,500	11,200	10,100	9,400	14,900	12,700	11,000	9,900
85	9,400	9,000	8,600	8,400	11,900	10,700	9,800	9,100	14,200	12,200	10,600	9,700
90	8,900	8,600	8,300	8,200	11,300	10,300	9,400	8,900	13,500	11,700	10,300	9,400
95	8,500	8,200	8,000		10,800	9,900	9,100	8,700	12,900	11,300	10,000	9,200
100	8,100	7,900			10,300	9,500	8,900	8,500	12,400	10,900	9,700	9,000
105					9,800	9,100	8,600	8,300	11,800	10,500	9,500	8,900
110					9,400	8,800	8,400	8,200	11,400	10,200	9,200	8,700
115					9,000	8,500	8,200	8,200	10,900	9,800	9,000	8,500
120					8,700	8,300	8,000		10,500	9,500	8,800	8,400
125					8,300	8,100	8,000		10,100	9,300	8,600	8,300
130									9,800	9,000	8,400	8,200
135									9,400	8,800	8,300	8,200
140									9,100	8,500	8,200	8,200
145									8,800	8,300	8,000	
150									8,500	8,100	8,000	
155									8,300	8,000		
Min Angle	0.0	0.0	0.0	0.0	14.0	18.5	0.0	0.0	15.5	18.5	27.0	11.5
Max Rad.	102.9	102.7	100.7	96.8	130.0	130.0	128.9	123.9	160.0	160.0	155.0	146.4
Capacity	6,200	6,400	7,000	8,200	0	0	2,000	2,300	0	0	0	0

1051070



PORTLAND OFFICE: 503.283.3111
 SEATTLE OFFICE: 206.784.1054
WWW.NESSCAMPBELL.COM

Rated Lifting Capacities in Pounds

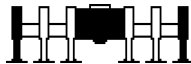

Full

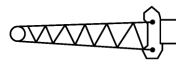

67ft Offset Fly

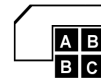

71,500 lbs



Radius (ft)	Boom Length (ft)											
	Fly Offset											
	134.9				167.1				183.6			
	2°	15°	30°	45°	2°	15°	30°	45°	2°	15°	30°	45°
30	15,900											
35	15,900				13,300							
40	15,900				13,300				12,400			
45	15,900	15,800			13,300				12,400			
50	15,900	15,800			13,300				12,400			
55	15,900	15,800			13,300	13,300			12,400			
60	15,900	15,800	13,300		13,300	13,300			12,400	12,300		
65	15,900	15,800	12,900		13,300	13,300			12,400	12,300		
70	15,900	15,100	12,400		13,300	13,300	13,000		12,400	12,300		
75	15,900	14,500	12,100	10,500	13,300	13,300	12,600		12,400	12,300	12,300	
80	15,900	14,000	11,700	10,300	13,300	13,300	12,300	10,600	12,400	12,300	12,300	
85	15,900	13,500	11,400	10,100	13,300	13,300	12,000	10,400	12,400	12,300	12,200	
90	15,700	13,000	11,100	9,800	13,300	13,300	11,600	10,200	12,400	12,300	11,900	10,300
95	15,000	12,600	10,800	9,600	13,300	13,300	11,400	10,000	12,400	12,300	11,600	10,100
100	14,400	12,100	10,500	9,500	13,300	13,300	11,100	9,800	12,400	12,300	11,400	10,000
105	13,800	11,700	10,200	9,300	13,300	12,900	10,800	9,600	12,400	12,300	11,100	9,800
110	13,300	11,400	10,000	9,100	13,300	12,500	10,600	9,500	12,400	12,300	10,900	9,600
115	12,800	11,000	9,700	9,000	13,300	12,100	10,400	9,300	12,400	12,300	10,600	9,500
120	12,300	10,700	9,500	8,800	13,300	11,800	10,100	9,200	12,400	12,300	10,400	9,300
125	11,900	10,400	9,300	8,700	13,000	11,500	9,900	9,000	12,400	12,000	10,200	9,200
130	11,400	10,100	9,100	8,600	12,300	11,200	9,700	8,900	12,400	11,600	10,000	9,100
135	11,100	9,900	8,900	8,500	11,600	10,900	9,500	8,800	11,300	11,400	9,800	9,000
140	10,700	9,600	8,800	8,400	11,000	10,600	9,400	8,700	10,400	11,100	9,600	8,900
145	10,300	9,400	8,600	8,300	10,400	10,300	9,200	8,600	9,500	10,400	9,500	8,700
150	9,800	9,100	8,500	8,200	9,700	10,000	9,000	8,500	8,700	9,500	9,300	8,600
155	9,300	8,900	8,300	8,200	9,000	9,500	8,900	8,400	7,900	8,700	9,200	8,600
160	8,900	8,700	8,200	8,100	8,200	8,900	8,800	8,300	7,200	7,900	8,700	8,500
165	8,400	8,500	8,100	8,100	7,600	8,200	8,600	8,300	6,500	7,200	7,900	8,400
170	8,000	8,100	8,000		6,900	7,500	8,000	8,200	5,900	6,600	7,200	7,600
175	7,700	7,700	7,800		6,400	6,900	7,400	7,600	5,300	5,900	6,500	6,900
180	7,300	7,400	7,400		5,800	6,300	6,700	6,900	4,800	5,400	5,900	6,200
185	6,900	7,000			5,300	5,700	6,100	6,300	4,200	4,800	5,300	5,500
190					4,800	5,200	5,500	5,600	3,800	4,300	4,700	4,900
195					4,400	4,700	5,000		3,300	3,800	4,200	4,300
200					3,900	4,300	4,500		2,900	3,300	3,700	3,800
205					3,500	3,800	4,000		2,500	2,900	3,200	3,200
210					3,100	3,400	3,500		2,100	2,400	2,700	
215					2,800	3,000					2,300	
220					2,500							
Min Angle	17.5	20.0	27.0	14.5	10.0	21.0	13.5	14.0	35.0	35.5	35.5	35.0
Max Rad. Capacity	190.0	190.0	185.0	177.6	225.0	220.0	218.7	209.7	211.3	215.0	218.0	217.0
	0	0	0	0	0	0	0	0	0	0	0	0

1051070



PORTLAND OFFICE: 503.283.3111
 SEATTLE OFFICE: 206.784.1054
WWW.NESSCAMPBELL.COM

Rated Lifting Capacities in Pounds

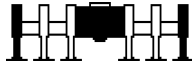

Full

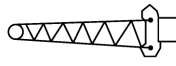

67ft Offset Fly



71,500 lbs



Radius (ft)	Boom Length (ft)			
	Fly Offset			
	200.1			
	2°	15°	30°	45°
45	10,800			
50	10,800			
55	10,800			
60	10,800			
65	10,800	10,800		
70	10,800	10,800		
75	10,800	10,800		
80	10,800	10,800	10,700	
85	10,800	10,800	10,700	
90	10,800	10,800	10,700	
95	10,800	10,800	10,700	10,300
100	10,800	10,800	10,700	10,100
105	10,800	10,800	10,700	9,900
110	10,800	10,800	10,700	9,800
115	10,800	10,800	10,700	9,600
120	10,800	10,800	10,700	9,500
125	10,800	10,800	10,500	9,400
130	10,800	10,800	10,300	9,200
135	10,400	10,800	10,100	9,100
140	9,400	10,500	9,900	9,000
145	8,600	9,600	9,700	8,900
150	7,700	8,700	9,600	8,800
155	7,000	7,900	8,800	8,700
160	6,300	7,100	7,900	8,500
165	5,600	6,400	7,200	7,700
170	5,000	5,700	6,500	7,000
175	4,400	5,100	5,800	6,200
180	3,800	4,500	5,200	5,600
185	3,300	4,000	4,600	4,900
190	2,800	3,500	4,000	4,300
195	2,400	3,000	3,500	3,700
200		2,500	2,900	3,200
205			2,500	2,600
210				2,100
Min Angle	45.0	46.0	46.0	46.5
Max Rad.	200.0	205.0	210.0	211.0
Capacity	0	0	0	0

1051070



PORTLAND OFFICE: 503.283.3111
 SEATTLE OFFICE: 206.784.1054
WWW.NESSCAMPBELL.COM

Rated Lifting Capacities in Pounds

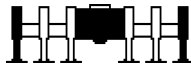

Full

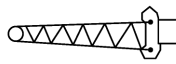

67ft Offset Fly



71,500 lbs



Radius (ft)	Boom Length (ft)											
	Fly Offset											
	44.3				58.9				89.1			
	2°	15°	30°	45°	2°	15°	30°	45°	2°	15°	30°	45°
15	30,000											
20	27,800				30,000				28,400			
25	24,600	19,800			26,900				28,400			
30	21,100	18,100			24,100	19,100			28,100			
35	19,100	16,600			21,100	17,700			25,600	19,300		
40	17,400	15,400	13,700		19,300	16,400			23,500	18,100		
45	16,000	14,300	12,800		17,800	15,300	13,300		21,100	17,000		
50	14,800	13,300	12,100		16,500	14,400	12,600		19,700	16,100	13,400	
55	13,800	12,500	11,400	10,600	15,400	13,500	12,000	10,900	18,400	15,200	12,900	
60	12,800	11,700	10,800	10,100	14,400	12,700	11,400	10,400	17,300	14,500	12,300	10,900
65	12,000	11,100	10,300	9,700	13,500	12,100	10,900	10,000	16,300	13,800	11,800	10,600
70	11,200	10,500	9,800	9,300	12,700	11,400	10,400	9,700	15,300	13,100	11,400	10,300
75	10,600	9,900	9,300	8,900	11,900	10,900	10,000	9,300	14,500	12,500	11,000	10,000
80	10,000	9,400	8,900	8,600	11,300	10,400	9,600	9,000	13,800	12,000	10,600	9,700
85	9,400	9,000	8,600	8,400	10,700	9,900	9,200	8,800	13,100	11,500	10,200	9,400
90	8,900	8,600	8,300	8,200	10,200	9,500	8,900	8,600	12,500	11,100	9,900	9,200
95	8,500	8,200	8,000		9,700	9,100	8,600	8,400	11,900	10,600	9,600	9,000
100	8,100	7,900			9,200	8,700	8,300	8,200	11,400	10,200	9,300	8,800
105					8,800	8,400	8,100		10,900	9,900	9,100	8,600
110					8,400	8,100	8,000		10,400	9,500	8,800	8,500
115					8,100	7,900			10,000	9,200	8,600	8,300
120									9,600	8,900	8,400	8,200
125									9,300	8,700	8,300	8,200
130									8,900	8,400	8,100	
135									8,600	8,200	8,000	
140									8,300	8,000	8,000	
145									8,100	7,900		
Min Angle	0.0	0.0	0.0	0.0	0.0	0.0	0.0	0.0	0.0	0.0	0.0	0.0
Max Rad.	102.9	102.7	100.7	96.8	117.5	117.1	114.7	110.2	147.7	147.1	144.1	138.7
Capacity	6,200	6,400	7,000	8,200	3,600	3,700	4,100	4,700	2,600	2,600	2,900	3,400

1051080



PORTLAND OFFICE: 503.283.3111
 SEATTLE OFFICE: 206.784.1054
WWW.NESSCAMPBELL.COM

Rated Lifting Capacities in Pounds

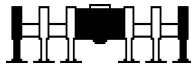

Full

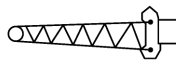

67ft Offset Fly



71,500 lbs



Radius (ft)	Boom Length (ft)											
	Fly Offset											
	120.3				152.4				169.0			
	2°	15°	30°	45°	2°	15°	30°	45°	2°	15°	30°	45°
25	19,500											
30	19,500											
35	19,500				16,600				15,500			
40	19,500				16,600				15,500			
45	19,500	18,400			16,600				15,500			
50	19,500	17,500			16,600	16,500			15,500			
55	19,500	16,600	13,500		16,600	16,500			15,500	15,500		
60	19,500	15,900	13,000		16,600	16,500			15,500	15,500		
65	18,900	15,200	12,600		16,600	16,400	13,100		15,500	15,500		
70	17,900	14,500	12,200	10,700	16,600	15,800	12,700		15,500	15,500	13,000	
75	17,000	14,000	11,800	10,400	16,600	15,200	12,400	10,700	15,500	15,500	12,600	
80	16,100	13,400	11,400	10,100	16,600	14,600	12,000	10,500	15,500	15,200	12,300	
85	15,400	12,900	11,100	9,900	16,600	14,100	11,700	10,200	15,500	14,700	12,000	10,400
90	14,700	12,400	10,700	9,700	16,600	13,600	11,400	10,000	15,500	14,200	11,700	10,200
95	14,000	12,000	10,400	9,500	16,100	13,200	11,100	9,800	15,500	13,700	11,400	10,000
100	13,400	11,600	10,200	9,300	15,400	12,800	10,800	9,700	15,500	13,300	11,100	9,800
105	12,900	11,200	9,900	9,100	14,800	12,400	10,600	9,500	15,500	12,900	10,900	9,700
110	12,400	10,800	9,600	8,900	14,300	12,000	10,300	9,300	15,200	12,500	10,600	9,500
115	11,900	10,500	9,400	8,800	13,700	11,600	10,100	9,200	14,600	12,200	10,400	9,300
120	11,500	10,200	9,200	8,600	13,300	11,300	9,900	9,000	14,100	11,800	10,200	9,200
125	11,100	9,900	9,000	8,500	12,800	11,000	9,700	8,900	13,200	11,500	10,000	9,100
130	10,700	9,600	8,800	8,400	12,400	10,700	9,500	8,800	12,100	11,200	9,800	8,900
135	10,300	9,300	8,600	8,300	12,000	10,400	9,300	8,700	11,100	10,900	9,600	8,800
140	10,000	9,100	8,500	8,200	11,200	10,200	9,100	8,500	10,100	10,700	9,400	8,700
145	9,600	8,900	8,300	8,200	10,300	9,900	8,900	8,500	9,200	10,100	9,200	8,600
150	9,300	8,700	8,200	8,200	9,500	9,700	8,800	8,400	8,400	9,200	9,100	8,500
155	9,100	8,500	8,100		8,700	9,400	8,600	8,300	7,600	8,400	8,900	8,400
160	8,800	8,300	8,000		8,000	8,600	8,500	8,200	6,900	7,600	8,300	8,300
165	8,500	8,100	8,000		7,300	7,900	8,400	8,200	6,200	6,900	7,600	8,000
170	8,300	8,000			6,700	7,200	7,700	7,900	5,600	6,300	6,900	7,200
175					6,100	6,600	7,000	7,100	5,000	5,600	6,200	6,400
180					5,600	6,000	6,400		4,500	5,100	5,500	5,700
185					5,100	5,500	5,700		4,000	4,500	4,900	5,100
190					4,600	4,900	5,200		3,500	4,000	4,300	4,400
195					4,200	4,400	4,600		3,100	3,500	3,800	
200					3,700	4,000			2,600	3,000	3,300	
205					3,400	3,500			2,200	2,600	2,800	
210										2,100	2,300	
Min Angle	17.5	20.5	28.0	3.5	11.0	7.5	11.0	29.0	29.0	29.5	29.0	28.0
Max Rad.	175.0	175.0	170.0	163.0	210.0	209.5	204.1	195.0	208.3	211.3	213.0	210.7
Capacity	0	0	0	0	0	0	0	0	0	0	0	0

1051080



PORTLAND OFFICE: 503.283.3111
 SEATTLE OFFICE: 206.784.1054
WWW.NESSCAMPBELL.COM

Rated Lifting Capacities in Pounds

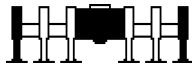

Full

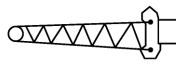

67ft Offset Fly



71,500 lbs



Radius (ft)	Boom Length (ft)			
	Fly Offset			
	185.5			
	2°	15°	30°	45°
40	13,500			
45	13,500			
50	13,500			
55	13,500			
60	13,500	13,500		
65	13,500	13,500		
70	13,500	13,500		
75	13,500	13,500	12,900	
80	13,500	13,500	12,500	
85	13,500	13,500	12,200	
90	13,500	13,500	11,900	10,300
95	13,500	13,500	11,700	10,100
100	13,500	13,500	11,400	10,000
105	13,500	13,400	11,100	9,800
110	13,500	13,000	10,900	9,600
115	13,500	12,700	10,700	9,500
120	13,500	12,300	10,500	9,400
125	12,300	12,000	10,200	9,200
130	11,100	11,700	10,000	9,100
135	10,100	11,200	9,900	9,000
140	9,100	10,200	9,700	8,900
145	8,200	9,200	9,500	8,800
150	7,400	8,400	9,300	8,700
155	6,700	7,600	8,400	8,600
160	6,000	6,800	7,600	8,200
165	5,300	6,100	6,800	7,300
170	4,700	5,400	6,100	6,600
175	4,100	4,800	5,400	5,800
180	3,500	4,200	4,800	5,100
185	3,000	3,600	4,200	4,500
190	2,600	3,100	3,600	3,900
195	2,100	2,600	3,100	3,300
200		2,200	2,600	2,700
205			2,100	2,100
Min Angle	42.0	42.0	42.5	42.5
Max Rad. Capacity	196.3	202.0	206.0	206.0
Capacity	0	0	0	0

1051080



PORTLAND OFFICE: 503.283.3111
 SEATTLE OFFICE: 206.784.1054
WWW.NESSCAMPBELL.COM

Rated Lifting Capacities in Pounds

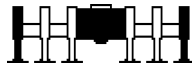

Full

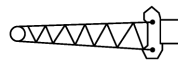

67ft Offset Fly



71,500 lbs



Boom Length (ft)												
Fly Offset												
Radius (ft)	44.3				73.5				103.8			
	2°	15°	30°	45°	2°	15°	30°	45°	2°	15°	30°	45°
15	30,000											
20	27,800				27,500							
25	24,600	19,800			27,500							
30	21,100	18,100			21,400				18,200			
35	19,100	16,600			21,400	18,500			18,200			
40	17,400	15,400	13,700		21,100	17,300			18,200			
45	16,000	14,300	12,800		19,500	16,200	13,700		18,200	17,700		
50	14,800	13,300	12,100		18,100	15,300	13,100		18,200	16,800		
55	13,800	12,500	11,400	10,600	16,900	14,400	12,400		18,200	15,900	13,200	
60	12,800	11,700	10,800	10,100	15,800	13,600	11,900	10,700	18,200	15,200	12,700	
65	12,000	11,100	10,300	9,700	14,900	12,900	11,400	10,300	17,500	14,500	12,200	10,800
70	11,200	10,500	9,800	9,300	14,000	12,300	10,900	10,000	16,600	13,800	11,800	10,500
75	10,600	9,900	9,300	8,900	13,200	11,700	10,500	9,700	15,700	13,200	11,400	10,200
80	10,000	9,400	8,900	8,600	12,500	11,200	10,100	9,400	14,900	12,700	11,000	9,900
85	9,400	9,000	8,600	8,400	11,900	10,700	9,800	9,100	14,200	12,200	10,600	9,700
90	8,900	8,600	8,300	8,200	11,300	10,300	9,400	8,900	13,500	11,700	10,300	9,400
95	8,500	8,200	8,000		10,800	9,900	9,100	8,700	12,900	11,300	10,000	9,200
100	8,100	7,900			10,300	9,500	8,900	8,500	12,400	10,900	9,700	9,000
105					9,800	9,100	8,600	8,300	11,800	10,500	9,500	8,900
110					9,400	8,800	8,400	8,200	11,400	10,200	9,200	8,700
115					9,000	8,500	8,200	8,200	10,900	9,800	9,000	8,500
120					8,700	8,300	8,000		10,500	9,500	8,800	8,400
125					8,300	8,100	8,000		10,100	9,300	8,600	8,300
130									9,800	9,000	8,400	8,200
135									9,400	8,800	8,300	8,200
140									9,100	8,500	8,200	8,200
145									8,800	8,300	8,000	
150									8,500	8,100	8,000	
155									8,300	8,000		
Min Angle	0.0	0.0	0.0	0.0	14.0	18.5	0.0	0.0	15.5	18.5	27.0	11.5
Max Rad.	102.9	102.7	100.7	96.8	130.0	130.0	128.9	123.9	160.0	160.0	155.0	146.4
Capacity	6,200	6,400	7,000	8,200	0	0	2,000	2,300	0	0	0	0

1051090



PORTLAND OFFICE: 503.283.3111
 SEATTLE OFFICE: 206.784.1054
WWW.NESSCAMPBELL.COM

Rated Lifting Capacities in Pounds

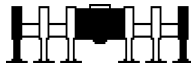

Full

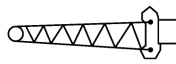

67ft Offset Fly



71,500 lbs



Radius (ft)	Boom Length (ft)											
	Fly Offset											
	119.4				135.4				152.0			
	2°	15°	30°	45°	2°	15°	30°	45°	2°	15°	30°	45°
30	17,800											
35	17,800				18,100				17,400			
40	17,800				18,100				17,400			
45	17,800				18,100	18,000			17,400			
50	17,800	17,400			18,100	18,000			17,400	17,300		
55	17,800	16,600			18,100	17,200			17,400	17,300		
60	17,800	15,800	13,000		18,100	16,500	13,300		17,400	17,100		
65	17,800	15,200	12,600		18,100	15,800	12,900		17,400	16,400	13,100	
70	17,800	14,500	12,100	10,600	18,100	15,100	12,500		17,400	15,700	12,700	
75	16,900	13,900	11,700	10,400	18,000	14,500	12,100	10,500	17,400	15,200	12,400	10,700
80	16,100	13,400	11,400	10,100	17,200	14,000	11,700	10,300	17,400	14,600	12,000	10,500
85	15,300	12,900	11,000	9,900	16,400	13,500	11,400	10,100	17,400	14,100	11,700	10,200
90	14,600	12,400	10,700	9,700	15,700	13,000	11,100	9,900	16,700	13,600	11,400	10,000
95	14,000	12,000	10,400	9,400	15,000	12,600	10,800	9,600	16,000	13,200	11,100	9,800
100	13,400	11,500	10,100	9,300	14,400	12,200	10,500	9,500	15,400	12,700	10,800	9,600
105	12,800	11,200	9,900	9,100	13,800	11,800	10,200	9,300	14,800	12,400	10,600	9,500
110	12,300	10,800	9,600	8,900	13,300	11,400	10,000	9,100	14,200	12,000	10,300	9,300
115	11,900	10,500	9,400	8,800	12,800	11,100	9,700	9,000	13,700	11,600	10,100	9,200
120	11,400	10,200	9,200	8,600	12,300	10,700	9,500	8,800	13,200	11,300	9,900	9,000
125	11,000	9,900	9,000	8,500	11,900	10,400	9,300	8,700	12,800	11,000	9,600	8,900
130	10,600	9,600	8,800	8,400	11,500	10,100	9,100	8,600	12,300	10,700	9,500	8,800
135	10,300	9,300	8,600	8,300	11,100	9,900	8,900	8,500	11,900	10,400	9,300	8,700
140	9,900	9,100	8,500	8,200	10,700	9,600	8,800	8,400	11,300	10,100	9,100	8,500
145	9,600	8,800	8,300	8,200	10,400	9,400	8,600	8,300	10,400	9,900	8,900	8,500
150	9,300	8,600	8,200	8,200	10,100	9,100	8,500	8,200	9,600	9,700	8,800	8,400
155	9,000	8,400	8,100		9,800	8,900	8,300	8,200	8,800	9,400	8,600	8,300
160	8,700	8,300	8,000		9,400	8,700	8,200	8,100	8,100	8,700	8,500	8,200
165	8,500	8,100	8,000		8,700	8,500	8,100	8,100	7,400	8,000	8,400	8,200
170	8,300	8,000			8,100	8,400	8,000		6,800	7,300	7,700	7,900
175					7,500	7,800	8,000		6,200	6,700	7,100	7,200
180					7,000	7,200	7,400		5,700	6,100	6,400	
185					6,500	6,700			5,200	5,500	5,800	
190									4,700	5,000	5,200	
195									4,200	4,500	4,600	
200									3,800	4,000		
205									3,400			
Min Angle	16.5	19.5	27.0	12.5	17.0	19.5	26.0	12.5	8.5	20.5	10.0	10.5
Max Rad. Capacity	175.0	175.0	170.0	162.0	190.0	190.0	185.0	178.1	210.0	205.0	203.6	194.6
	0	0	0	0	0	0	0	0	0	0	0	0

1051090



PORTLAND OFFICE: 503.283.3111
 SEATTLE OFFICE: 206.784.1054
WWW.NESSCAMPBELL.COM

Rated Lifting Capacities in Pounds

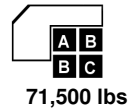
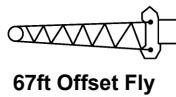
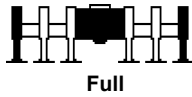

Radius (ft)	Boom Length (ft)			
	Fly Offset			
	168.5			
	2°	15°	30°	45°
35	15,300			
40	15,300			
45	15,300			
50	15,300			
55	15,300	15,200		
60	15,300	15,200		
65	15,300	15,200		
70	15,300	15,200	13,000	
75	15,300	15,200	12,600	
80	15,300	15,200	12,300	
85	15,300	14,600	12,000	10,400
90	15,300	14,200	11,700	10,200
95	15,300	13,700	11,400	10,000
100	15,300	13,300	11,100	9,800
105	15,300	12,900	10,900	9,600
110	15,200	12,500	10,600	9,500
115	14,600	12,200	10,400	9,300
120	14,100	11,800	10,200	9,200
125	13,300	11,500	10,000	9,100
130	12,200	11,200	9,800	8,900
135	11,100	10,900	9,600	8,800
140	10,200	10,600	9,400	8,700
145	9,300	10,200	9,200	8,600
150	8,400	9,300	9,100	8,500
155	7,700	8,500	8,900	8,400
160	7,000	7,700	8,400	8,300
165	6,300	7,000	7,600	8,000
170	5,700	6,300	6,900	7,200
175	5,100	5,700	6,200	6,500
180	4,600	5,100	5,600	5,800
185	4,000	4,500	5,000	5,100
190	3,600	4,000	4,400	4,500
195	3,100	3,500	3,800	
200	2,700	3,000	3,300	
205	2,300	2,600	2,800	
210		2,200	2,300	
Min Angle	27.5	28.0	28.5	27.0
Max Rad.	208.8	212.5	213.0	210.7
Capacity	0	0	0	0

1051090



PORTLAND OFFICE: 503.283.3111
 SEATTLE OFFICE: 206.784.1054
WWW.NESSCAMPBELL.COM

Rated Lifting Capacities in Pounds

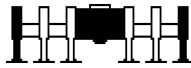

Full

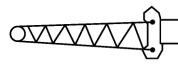

67ft Hydraulic Offset Fly



71,500 lbs



Radius (ft)	Boom Length (ft)											
	Fly Offset											
	44.3			73.5			103.8			134.9		
	2°-15°	15°-30°	30°-45°	2°-15°	15°-30°	30°-45°	2°-15°	15°-30°	30°-45°	2°-15°	15°-30°	30°-45°
15	30,000											
20	27,800			27,500								
25	19,800	19,800		27,500			18,200					
30	18,100	18,100		19,900	19,900		18,200			15,900		
35	16,600	16,600		18,500	18,500		18,200			15,900		
40	15,400	13,700	13,700	17,300	17,300		18,100	18,100		15,900		
45	14,300	12,800	12,800	16,200	13,700	13,700	17,700	17,700		15,800	15,800	
50	13,300	12,100	11,100	15,300	13,100	13,100	16,800	13,800	13,800	15,800	15,800	
55	12,500	11,400	10,600	14,400	12,400	11,100	15,900	13,200	13,200	15,800	15,800	
60	11,700	10,800	10,100	13,600	11,900	10,700	15,200	12,700	12,700	15,800	13,300	13,300
65	11,100	10,300	9,700	12,900	11,400	10,300	14,500	12,200	10,800	15,800	12,900	12,900
70	10,500	9,800	9,300	12,300	10,900	10,000	13,800	11,800	10,500	15,100	12,400	10,800
75	9,900	9,300	8,900	11,700	10,500	9,700	13,200	11,400	10,200	14,500	12,100	10,500
80	9,400	8,900	8,600	11,200	10,100	9,400	12,700	11,000	9,900	14,000	11,700	10,300
85	9,000	8,600	8,400	10,700	9,800	9,100	12,200	10,600	9,700	13,500	11,400	10,100
90	8,600	8,300	8,200	10,300	9,400	8,900	11,700	10,300	9,400	13,000	11,100	9,800
95	8,200	8,000	8,000	9,900	9,100	8,700	11,300	10,000	9,200	12,600	10,800	9,600
100	7,900	7,900		9,500	8,900	8,500	10,900	9,700	9,000	12,100	10,500	9,500
105				9,100	8,600	8,300	10,500	9,500	8,900	11,700	10,200	9,300
110				8,800	8,400	8,200	10,200	9,200	8,700	11,400	10,000	9,100
115				8,500	8,200	8,200	9,800	9,000	8,500	11,000	9,700	9,000
120				8,300	8,000	8,000	9,500	8,800	8,400	10,700	9,500	8,800
125				8,100	8,000	8,000	9,300	8,600	8,300	10,400	9,300	8,700
130							9,000	8,400	8,200	10,100	9,100	8,600
135							8,800	8,300	8,200	9,900	8,900	8,500
140							8,500	8,200	8,200	9,600	8,800	8,400
145							8,300	8,000	8,000	9,400	8,600	8,300
150							8,100	8,000		9,100	8,500	8,200
155							8,000			8,900	8,300	8,200
160										8,700	8,200	8,100
165										8,400	8,100	8,100
170										8,000	8,000	8,000
175										7,700	7,700	7,800
180										7,300	7,400	
185										6,900		
Min Angle	0.0	0.0	0.0	14.0	18.5	0.0	15.5	27.0	11.5	17.5	27.0	14.5
Max Rad.	102.9	102.7	100.7	130.0	130.0	128.9	160.0	155.0	146.4	190.0	185.0	177.6
Capacity	6,200	6,400	7,000	0	0	2,000	0	0	0	0	0	0

1052070



PORTLAND OFFICE: 503.283.3111
 SEATTLE OFFICE: 206.784.1054
WWW.NESSCAMPBELL.COM

Rated Lifting Capacities in Pounds

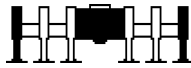

Full

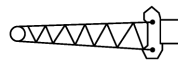

67ft Hydraulic Offset Fly



71,500 lbs



Radius (ft)	Boom Length (ft)								
	Fly Offset								
	167.1			183.6			200.1		
	2°-15°	15°-30°	30°-45°	2°-15°	15°-30°	30°-45°	2°-15°	15°-30°	30°-45°
35	13,300								
40	13,300			12,400					
45	13,300			12,400			10,800		
50	13,200	13,200		12,400			10,800		
55	13,200	13,200		12,300	12,300		10,800		
60	13,200	13,200		12,300	12,300		10,800	10,800	
65	13,200	13,200	13,200	12,300	12,300		10,800	10,800	
70	13,200	13,000	13,000	12,300	12,200	12,200	10,800	10,800	
75	13,200	12,600	12,600	12,300	12,200	12,200	10,800	10,700	10,700
80	13,200	12,300	10,600	12,300	12,200	12,200	10,800	10,700	10,700
85	13,200	12,000	10,400	12,300	12,200	10,500	10,800	10,700	10,700
90	13,200	11,600	10,200	12,300	11,900	10,300	10,800	10,700	10,400
95	13,200	11,400	10,000	12,300	11,600	10,100	10,800	10,700	10,300
100	13,200	11,100	9,800	12,300	11,400	10,000	10,800	10,700	10,100
105	12,900	10,800	9,600	12,300	11,100	9,800	10,800	10,700	9,900
110	12,500	10,600	9,500	12,300	10,900	9,600	10,800	10,700	9,800
115	12,100	10,400	9,300	12,300	10,600	9,500	10,800	10,700	9,600
120	11,800	10,100	9,200	12,300	10,400	9,300	10,800	10,700	9,500
125	11,500	9,900	9,000	12,000	10,200	9,200	10,800	10,500	9,400
130	11,200	9,700	8,900	11,600	10,000	9,100	10,800	10,300	9,200
135	10,900	9,500	8,800	11,300	9,800	9,000	10,400	10,100	9,100
140	10,600	9,400	8,700	10,400	9,600	8,900	9,400	9,900	9,000
145	10,300	9,200	8,600	9,500	9,500	8,700	8,600	9,600	8,900
150	9,700	9,000	8,500	8,700	9,300	8,600	7,700	8,700	8,800
155	9,000	8,900	8,400	7,900	8,700	8,600	7,000	7,900	8,700
160	8,200	8,800	8,300	7,200	7,900	8,500	6,300	7,100	7,900
165	7,600	8,200	8,300	6,500	7,200	7,900	5,600	6,400	7,200
170	6,900	7,500	8,000	5,900	6,600	7,200	5,000	5,700	6,500
175	6,400	6,900	7,400	5,300	5,900	6,500	4,400	5,100	5,800
180	5,800	6,300	6,700	4,800	5,400	5,900	3,800	4,500	5,200
185	5,300	5,700	6,100	4,200	4,800	5,300	3,300	4,000	4,600
190	4,800	5,200	5,500	3,800	4,300	4,700	2,800	3,500	4,000
195	4,400	4,700	5,000	3,300	3,800	4,200	2,400	3,000	3,500
200	3,900	4,300	4,400	2,900	3,300	3,700		2,500	2,900
205	3,500	3,800	3,900	2,500	2,900	3,200			2,500
210	3,100	3,400		2,100	2,400	2,700			
215	2,800	3,000				2,200			
Min Angle	21.0	13.5	14.0	35.0	35.5	35.0	45.0	46.0	46.0
Max Rad. Capacity	220.0	218.7	209.7	211.3	215.0	217.0	200.0	205.0	210.0
	0	0	0	0	0	0	0	0	0

1052070



PORTLAND OFFICE: 503.283.3111
 SEATTLE OFFICE: 206.784.1054
WWW.NESSCAMPBELL.COM

Rated Lifting Capacities in Pounds

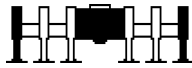

Full

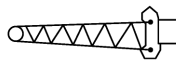

67ft Hydraulic Offset Fly



71,500 lbs



Boom Length (ft)												
Fly Offset												
Radius (ft)	44.3			58.9			89.1			120.3		
	2°-15°	15°-30°	30°-45°	2°-15°	15°-30°	30°-45°	2°-15°	15°-30°	30°-45°	2°-15°	15°-30°	30°-45°
15	30,000											
20	27,800			30,300			28,400					
25	19,800	19,800		26,900			28,400			19,500		
30	18,100	18,100		19,100	19,100		28,100			19,500		
35	16,600	16,600		17,700	17,700		19,300	19,300		19,500		
40	15,400	13,700	13,700	16,400	14,100	14,100	18,100	18,100		19,400	19,400	
45	14,300	12,800	12,800	15,300	13,300	13,300	17,000	14,100	14,100	18,400	18,400	
50	13,300	12,100	11,100	14,400	12,600	12,600	16,100	13,400	13,400	17,500	17,500	
55	12,500	11,400	10,600	13,500	12,000	10,900	15,200	12,900	12,900	16,600	13,500	13,500
60	11,700	10,800	10,100	12,700	11,400	10,400	14,500	12,300	10,900	15,900	13,000	13,000
65	11,100	10,300	9,700	12,100	10,900	10,000	13,800	11,800	10,600	15,200	12,600	10,900
70	10,500	9,800	9,300	11,400	10,400	9,700	13,100	11,400	10,300	14,500	12,200	10,700
75	9,900	9,300	8,900	10,900	10,000	9,300	12,500	11,000	10,000	14,000	11,800	10,400
80	9,400	8,900	8,600	10,400	9,600	9,000	12,000	10,600	9,700	13,400	11,400	10,100
85	9,000	8,600	8,400	9,900	9,200	8,800	11,500	10,200	9,400	12,900	11,100	9,900
90	8,600	8,300	8,200	9,500	8,900	8,600	11,100	9,900	9,200	12,400	10,700	9,700
95	8,200	8,000	8,000	9,100	8,600	8,400	10,600	9,600	9,000	12,000	10,400	9,500
100	7,900	7,900		8,700	8,300	8,200	10,200	9,300	8,800	11,600	10,200	9,300
105				8,400	8,100	8,100	9,900	9,100	8,600	11,200	9,900	9,100
110				8,100	8,000	8,000	9,500	8,800	8,500	10,800	9,600	8,900
115				7,900	7,900		9,200	8,600	8,300	10,500	9,400	8,800
120							8,900	8,400	8,200	10,200	9,200	8,600
125							8,700	8,300	8,200	9,900	9,000	8,500
130							8,400	8,100	8,100	9,600	8,800	8,400
135							8,200	8,000	8,000	9,300	8,600	8,300
140							8,000	8,000	8,000	9,100	8,500	8,200
145							7,900	7,900		8,900	8,300	8,200
150										8,700	8,200	8,200
155										8,500	8,100	8,100
160										8,300	8,000	8,000
165										8,100	8,000	
170										8,000		
Min Angle	0.0	0.0	0.0	0.0	0.0	0.0	0.0	0.0	0.0	17.5	28.0	3.5
Max Rad.	102.9	102.7	100.7	117.5	117.1	114.7	147.7	147.1	144.1	175.0	170.0	163.0
Capacity	6,200	6,400	7,000	3,600	3,700	4,100	2,600	2,600	2,900	0	0	0

1052080



PORTLAND OFFICE: 503.283.3111
 SEATTLE OFFICE: 206.784.1054
WWW.NESSCAMPBELL.COM

Rated Lifting Capacities in Pounds

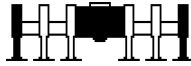

Full

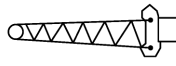

67ft Hydraulic Offset Fly



71,500 lbs



Radius (ft)	Boom Length (ft)								
	Fly Offset								
	152.4			169.0			185.5		
	2°-15°	15°-30°	30°-45°	2°-15°	15°-30°	30°-45°	2°-15°	15°-30°	30°-45°
35	16,600			15,500					
40	16,600			15,500			13,500		
45	16,600			15,500			13,500		
50	16,500	16,500		15,400	15,400		13,500		
55	16,500	16,500		15,400	15,400		13,500	13,500	
60	16,500	16,500		15,400	15,400		13,500	13,500	
65	16,400	13,100	13,100	15,400	13,400	13,400	13,500	13,500	
70	15,800	12,700	12,700	15,400	13,000	13,000	13,500	13,200	13,200
75	15,200	12,400	10,700	15,400	12,600	12,600	13,500	12,900	12,900
80	14,600	12,000	10,500	15,200	12,300	10,600	13,500	12,500	12,500
85	14,100	11,700	10,200	14,700	12,000	10,400	13,500	12,200	10,500
90	13,600	11,400	10,000	14,200	11,700	10,200	13,500	11,900	10,300
95	13,200	11,100	9,800	13,700	11,400	10,000	13,500	11,700	10,100
100	12,800	10,800	9,700	13,300	11,100	9,800	13,500	11,400	10,000
105	12,400	10,600	9,500	12,900	10,900	9,700	13,400	11,100	9,800
110	12,000	10,300	9,300	12,500	10,600	9,500	13,000	10,900	9,600
115	11,600	10,100	9,200	12,200	10,400	9,300	12,700	10,700	9,500
120	11,300	9,900	9,000	11,800	10,200	9,200	12,300	10,500	9,400
125	11,000	9,700	8,900	11,500	10,000	9,100	12,000	10,200	9,200
130	10,700	9,500	8,800	11,200	9,800	8,900	11,100	10,000	9,100
135	10,400	9,300	8,700	10,900	9,600	8,800	10,100	9,900	9,000
140	10,200	9,100	8,500	10,100	9,400	8,700	9,100	9,700	8,900
145	9,900	8,900	8,500	9,200	9,200	8,600	8,200	9,200	8,800
150	9,500	8,800	8,400	8,400	9,100	8,500	7,400	8,400	8,700
155	8,700	8,600	8,300	7,600	8,400	8,400	6,700	7,600	8,400
160	8,000	8,500	8,200	6,900	7,600	8,300	6,000	6,800	7,600
165	7,300	7,900	8,200	6,200	6,900	7,600	5,300	6,100	6,800
170	6,700	7,200	7,700	5,600	6,300	6,900	4,700	5,400	6,100
175	6,100	6,600	7,000	5,000	5,600	6,200	4,100	4,800	5,400
180	5,600	6,000	6,400	4,500	5,100	5,500	3,500	4,200	4,800
185	5,100	5,500	5,700	4,000	4,500	4,900	3,000	3,600	4,200
190	4,600	4,900	5,100	3,500	4,000	4,300	2,600	3,100	3,600
195	4,200	4,400		3,100	3,500	3,800	2,100	2,600	3,100
200	3,700	4,000		2,600	3,000	3,200		2,200	2,600
205	3,400			2,200	2,600	2,700			2,100
210					2,100	2,100			

Min Angle	7.5	11.0	29.0	29.0	29.5	28.0	42.0	42.0	42.5
Max Rad.	209.5	204.1	195.0	208.3	211.3	210.7	196.3	202.0	206.0
Capacity	0	0	0	0	0	0	0	0	0

1052080



PORTLAND OFFICE: 503.283.3111
 SEATTLE OFFICE: 206.784.1054
WWW.NESSCAMPBELL.COM

Rated Lifting Capacities in Pounds

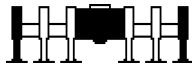

Full

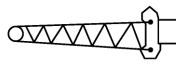

67ft Hydraulic Offset Fly



71,500 lbs



Radius (ft)	Boom Length (ft)											
	Fly Offset											
	44.3			73.5			103.8			119.4		
	2°-15°	15°-30°	30°-45°	2°-15°	15°-30°	30°-45°	2°-15°	15°-30°	30°-45°	2°-15°	15°-30°	30°-45°
15	30,000											
20	27,800			27,500								
25	19,800	19,800		27,500			18,200					
30	18,100	18,100		19,900	19,900		18,200			17,800		
35	16,600	16,600		18,500	18,500		18,200			17,800		
40	15,400	13,700	13,700	17,300	17,300		18,100	18,100		17,700	17,700	
45	14,300	12,800	12,800	16,200	13,700	13,700	17,700	17,700		17,700	17,700	
50	13,300	12,100	11,100	15,300	13,100	13,100	16,800	13,800	13,800	17,400	17,400	
55	12,500	11,400	10,600	14,400	12,400	11,100	15,900	13,200	13,200	16,600	13,500	13,500
60	11,700	10,800	10,100	13,600	11,900	10,700	15,200	12,700	12,700	15,800	13,000	13,000
65	11,100	10,300	9,700	12,900	11,400	10,300	14,500	12,200	10,800	15,200	12,600	12,600
70	10,500	9,800	9,300	12,300	10,900	10,000	13,800	11,800	10,500	14,500	12,100	10,600
75	9,900	9,300	8,900	11,700	10,500	9,700	13,200	11,400	10,200	13,900	11,700	10,400
80	9,400	8,900	8,600	11,200	10,100	9,400	12,700	11,000	9,900	13,400	11,400	10,100
85	9,000	8,600	8,400	10,700	9,800	9,100	12,200	10,600	9,700	12,900	11,000	9,900
90	8,600	8,300	8,200	10,300	9,400	8,900	11,700	10,300	9,400	12,400	10,700	9,700
95	8,200	8,000	8,000	9,900	9,100	8,700	11,300	10,000	9,200	12,000	10,400	9,400
100	7,900	7,900		9,500	8,900	8,500	10,900	9,700	9,000	11,500	10,100	9,300
105				9,100	8,600	8,300	10,500	9,500	8,900	11,200	9,900	9,100
110				8,800	8,400	8,200	10,200	9,200	8,700	10,800	9,600	8,900
115				8,500	8,200	8,200	9,800	9,000	8,500	10,500	9,400	8,800
120				8,300	8,000	8,000	9,500	8,800	8,400	10,200	9,200	8,600
125				8,100	8,000	8,000	9,300	8,600	8,300	9,900	9,000	8,500
130							9,000	8,400	8,200	9,600	8,800	8,400
135							8,800	8,300	8,200	9,300	8,600	8,300
140							8,500	8,200	8,200	9,100	8,500	8,200
145							8,300	8,000	8,000	8,800	8,300	8,200
150							8,100	8,000		8,600	8,200	8,200
155							8,000			8,400	8,100	8,100
160										8,300	8,000	8,000
165										8,100	8,000	
170										8,000		
Min Angle	0.0	0.0	0.0	14.0	18.5	0.0	15.5	27.0	11.5	16.5	27.0	12.5
Max Rad.	102.9	102.7	100.7	130.0	130.0	128.9	160.0	155.0	146.4	175.0	170.0	162.0
Capacity	6,200	6,400	7,000	0	0	2,000	0	0	0	0	0	0

1052090



PORTLAND OFFICE: 503.283.3111
 SEATTLE OFFICE: 206.784.1054
WWW.NESSCAMPBELL.COM

Rated Lifting Capacities in Pounds

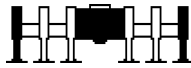

Full

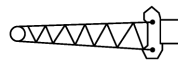

67ft Hydraulic Offset Fly



71,500 lbs



Boom Length (ft)									
Fly Offset									
Radius (ft)	135.4			152.0			168.5		
	2°-15°	15°-30°	30°-45°	2°-15°	15°-30°	30°-45°	2°-15°	15°-30°	30°-45°
35	18,100			17,400			15,300		
40	18,100			17,400			15,300		
45	18,000	18,000		17,400			15,300		
50	18,000	18,000		17,300	17,300		15,200	15,200	
55	17,200	17,200		17,300	17,300		15,200	15,200	
60	16,500	13,300	13,300	17,100	17,100		15,200	15,200	
65	15,800	12,900	12,900	16,400	13,100	13,100	15,200	15,200	
70	15,100	12,500	12,500	15,700	12,700	10,900	15,200	13,000	13,000
75	14,500	12,100	10,500	15,200	12,400	10,700	15,200	12,600	12,600
80	14,000	11,700	10,300	14,600	12,000	10,500	15,200	12,300	10,600
85	13,500	11,400	10,100	14,100	11,700	10,200	14,600	12,000	10,400
90	13,000	11,100	9,900	13,600	11,400	10,000	14,200	11,700	10,200
95	12,600	10,800	9,600	13,200	11,100	9,800	13,700	11,400	10,000
100	12,200	10,500	9,500	12,700	10,800	9,600	13,300	11,100	9,800
105	11,800	10,200	9,300	12,400	10,600	9,500	12,900	10,900	9,600
110	11,400	10,000	9,100	12,000	10,300	9,300	12,500	10,600	9,500
115	11,100	9,700	9,000	11,600	10,100	9,200	12,200	10,400	9,300
120	10,700	9,500	8,800	11,300	9,900	9,000	11,800	10,200	9,200
125	10,400	9,300	8,700	11,000	9,600	8,900	11,500	10,000	9,100
130	10,100	9,100	8,600	10,700	9,500	8,800	11,200	9,800	8,900
135	9,900	8,900	8,500	10,400	9,300	8,700	10,900	9,600	8,800
140	9,600	8,800	8,400	10,100	9,100	8,500	10,200	9,400	8,700
145	9,400	8,600	8,300	9,900	8,900	8,500	9,300	9,200	8,600
150	9,100	8,500	8,200	9,600	8,800	8,400	8,400	9,100	8,500
155	8,900	8,300	8,200	8,800	8,600	8,300	7,700	8,500	8,400
160	8,700	8,200	8,100	8,100	8,500	8,200	7,000	7,700	8,300
165	8,500	8,100	8,100	7,400	8,000	8,200	6,300	7,000	7,600
170	8,100	8,000	8,000	6,800	7,300	7,700	5,700	6,300	6,900
175	7,500	7,800	7,900	6,200	6,700	7,100	5,100	5,700	6,200
180	7,000	7,200		5,700	6,100	6,400	4,600	5,100	5,600
185	6,500			5,200	5,500	5,800	4,000	4,500	5,000
190				4,700	5,000	5,100	3,600	4,000	4,400
195				4,200	4,500		3,100	3,500	3,800
200				3,800	4,000		2,700	3,000	3,300
205							2,300	2,600	2,700
210								2,200	2,100
Min Angle	17.0	26.0	12.5	20.5	10.0	10.5	27.5	28.0	27.0
Max Rad. Capacity	190.0	185.0	178.1	205.0	203.6	194.6	208.8	212.5	210.7
	0	0	0	0	0	0	0	0	0

1052090



PORTLAND OFFICE: 503.283.3111
 SEATTLE OFFICE: 206.784.1054
WWW.NESSCAMPBELL.COM

Rated Lifting Capacities in Pounds

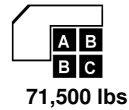
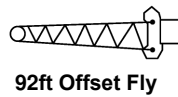
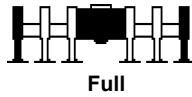

Radius (ft)	Boom Length (ft)											
	Fly Offset											
	44.3				73.5				103.8			
	2°	15°	30°	45°	2°	15°	30°	45°	2°	15°	30°	45°
20	19,800											
25	18,100				17,300							
30	16,700				17,300				15,200			
35	15,500	14,400			17,300				15,200			
40	14,400	13,400			16,300	14,600			15,200			
45	13,400	12,600	11,900		15,300	13,800			15,200	14,700		
50	12,600	11,800	11,200		14,400	13,100			15,200	14,000		
55	11,800	11,200	10,600		13,600	12,400	11,400		15,200	13,400		
60	11,100	10,500	10,000	9,700	12,900	11,800	10,900		14,400	12,800	11,500	
65	10,500	10,000	9,500	9,300	12,200	11,200	10,400	9,800	13,700	12,200	11,000	
70	9,900	9,500	9,100	8,800	11,600	10,700	10,000	9,400	13,100	11,700	10,600	9,800
75	9,400	9,000	8,700	8,400	11,000	10,200	9,500	9,100	12,500	11,300	10,200	9,500
80	8,900	8,600	8,300	8,100	10,500	9,800	9,200	8,700	12,000	10,800	9,900	9,200
85	8,400	8,100	7,800	7,700	10,000	9,400	8,800	8,400	11,500	10,400	9,500	8,900
90	7,900	7,700	7,400	7,300	9,600	9,000	8,500	8,200	11,000	10,000	9,200	8,700
95	7,400	7,200	7,100	7,000	9,200	8,700	8,200	7,900	10,600	9,700	8,900	8,400
100	7,000	6,800	6,700	6,600	8,800	8,300	7,800	7,600	10,200	9,300	8,600	8,200
105	6,500	6,400	6,300	6,300	8,400	7,900	7,500	7,300	9,800	9,000	8,400	8,000
110	6,100	6,000	6,000	6,000	8,000	7,600	7,200	7,000	9,400	8,700	8,100	7,700
115	5,800	5,700	5,700		7,600	7,200	6,900	6,800	9,100	8,400	7,800	7,500
120	5,400	5,400	5,400		7,200	6,900	6,600	6,500	8,800	8,100	7,600	7,300
125	5,100	5,100			6,800	6,500	6,300	6,300	8,400	7,800	7,300	7,100
130					6,500	6,200	6,100	6,100	8,100	7,500	7,100	6,900
135					6,100	6,000	5,800	5,900	7,700	7,200	6,800	6,700
140					5,800	5,700	5,600		7,400	6,900	6,600	6,400
145					5,600	5,500	5,400		7,000	6,700	6,400	6,300
150					5,300	5,200			6,700	6,400	6,200	6,100
155									6,400	6,200	6,000	5,900
160									6,200	5,900	5,800	5,800
165									5,900	5,700	5,600	
170									5,700	5,500	5,400	
175									5,500	5,300	5,300	
180									5,300	5,200		
Min Angle	0.0	0.0	0.0	0.0	14.0	17.0	26.5	26.0	15.5	17.5	25.0	22.5
Max Rad.	127.9	127.5	124.9	120.1	155.0	155.0	150.0	141.2	185.0	185.0	180.0	171.4
Capacity	3,100	3,100	3,400	3,900	0	0	0	0	0	0	0	0

1051100



PORTLAND OFFICE: 503.283.3111
 SEATTLE OFFICE: 206.784.1054
WWW.NESSCAMPBELL.COM

Rated Lifting Capacities in Pounds

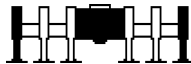

Full

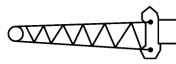

92ft Offset Fly



71,500 lbs



Radius (ft)	Boom Length (ft)											
	Fly Offset											
	134.9				167.1				183.6			
	2°	15°	30°	45°	2°	15°	30°	45°	2°	15°	30°	45°
35	12,900											
40	12,900											
45	12,900				10,400							
50	12,900				10,400				9,600			
55	12,900	12,800			10,400				9,600			
60	12,900	12,800			10,400	10,300			9,600			
65	12,900	12,800			10,400	10,300			9,600			
70	12,900	12,600	11,200		10,400	10,300			9,600	9,500		
75	12,900	12,200	10,800		10,400	10,300			9,600	9,500		
80	12,900	11,700	10,500	9,600	10,400	10,300	10,200		9,600	9,500		
85	12,800	11,300	10,100	9,300	10,400	10,300	10,200		9,600	9,500	9,400	
90	12,300	10,900	9,800	9,100	10,400	10,300	10,200	9,400	9,600	9,500	9,400	
95	11,800	10,600	9,500	8,900	10,400	10,300	10,100	9,200	9,600	9,500	9,400	9,300
100	11,400	10,200	9,300	8,600	10,400	10,300	9,800	9,000	9,600	9,500	9,400	9,100
105	11,000	9,900	9,000	8,400	10,400	10,300	9,500	8,800	9,600	9,500	9,400	9,000
110	10,600	9,600	8,800	8,200	10,400	10,300	9,300	8,600	9,600	9,500	9,400	8,800
115	10,300	9,300	8,500	8,000	10,400	10,100	9,100	8,400	9,600	9,500	9,300	8,600
120	9,900	9,000	8,300	7,800	10,400	9,800	8,900	8,300	9,600	9,500	9,100	8,400
125	9,600	8,800	8,100	7,600	10,400	9,600	8,700	8,100	9,600	9,500	8,900	8,300
130	9,300	8,500	7,900	7,400	10,400	9,300	8,500	7,900	9,600	9,500	8,700	8,100
135	9,000	8,300	7,600	7,300	10,000	9,100	8,300	7,700	9,600	9,400	8,500	8,000
140	8,700	8,000	7,400	7,100	9,800	8,800	8,100	7,600	9,600	9,200	8,300	7,800
145	8,400	7,700	7,200	6,900	9,300	8,600	7,900	7,400	9,400	9,000	8,200	7,600
150	8,100	7,500	7,000	6,700	8,800	8,400	7,700	7,200	8,600	8,800	8,000	7,500
155	7,800	7,200	6,800	6,600	8,300	8,200	7,500	7,100	7,800	8,600	7,800	7,300
160	7,500	7,000	6,600	6,400	7,800	7,900	7,300	7,000	7,100	8,000	7,600	7,200
165	7,200	6,800	6,400	6,300	7,300	7,600	7,100	6,800	6,400	7,200	7,400	7,000
170	6,900	6,500	6,200	6,100	6,800	7,200	7,000	6,700	5,800	6,600	7,300	6,900
175	6,500	6,300	6,000	6,000	6,200	6,800	6,800	6,500	5,200	5,900	6,600	6,800
180	6,200	6,100	5,900	5,900	5,700	6,300	6,600	6,400	4,700	5,300	6,000	6,400
185	5,900	5,900	5,700	5,800	5,200	5,700	6,200	6,300	4,100	4,800	5,400	5,700
190	5,500	5,700	5,600		4,700	5,200	5,600	5,900	3,700	4,300	4,800	5,100
195	5,200	5,400	5,400		4,200	4,700	5,100	5,300	3,200	3,800	4,300	4,600
200	5,000	5,100	5,100		3,800	4,200	4,600	4,800	2,800	3,300	3,800	4,000
205	4,700	4,800	4,800		3,400	3,800	4,100	4,200	2,300	2,800	3,300	3,500
210	4,500	4,500			3,000	3,300	3,600	3,700		2,400	2,800	3,000
215					2,600	2,900	3,200				2,400	2,500
220					2,200	2,600	2,800					
225						2,200	2,400					
Min Angle	17.5	19.5	26.0	19.5	34.0	34.0	34.0	33.5	45.5	46.0	46.5	46.0
Max Rad. Capacity	215.0	215.0	210.0	202.6	223.3	227.5	230.0	228.0	208.8	215.0	219.0	220.0
	0	0	0	0	0	0	0	0	0	0	0	0

1051100



PORTLAND OFFICE: 503.283.3111
 SEATTLE OFFICE: 206.784.1054
WWW.NESSCAMPBELL.COM

Rated Lifting Capacities in Pounds

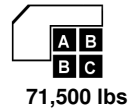
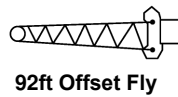
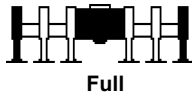

Radius (ft)	Boom Length (ft)			
	Fly Offset			
	200.1			
	2°	15°	30°	45°
55	8,200			
60	8,200			
65	8,200			
70	8,200			
75	8,200	8,100		
80	8,200	8,100		
85	8,200	8,100		
90	8,200	8,100	8,000	
95	8,200	8,100	8,000	
100	8,200	8,100	8,000	7,800
105	8,200	8,100	8,000	7,800
110	8,200	8,100	8,000	7,800
115	8,200	8,100	8,000	7,800
120	8,200	8,100	8,000	7,800
125	8,200	8,100	8,000	7,800
130	8,200	8,100	8,000	7,800
135	8,200	8,100	8,000	7,800
140	8,200	8,100	8,000	7,800
145	8,200	8,100	8,000	7,800
150	7,700	8,100	8,000	7,700
155	6,900	7,900	8,000	7,500
160	6,200	7,100	7,900	7,400
165	5,500	6,400	7,300	7,200
170	4,900	5,700	6,500	7,100
175	4,300	5,100	5,900	6,400
180	3,800	4,500	5,200	5,700
185	3,200	4,000	4,600	5,100
190	2,700	3,400	4,100	4,500
195	2,300	2,900	3,500	3,900
200		2,500	3,000	3,300
205			2,500	2,800
210			2,100	2,300
Min Angle	53.0	53.5	53.5	53.5
Max Rad.	198.0	205.0	211.0	213.8
Capacity	0	0	0	0

1051100



PORTLAND OFFICE: 503.283.3111
 SEATTLE OFFICE: 206.784.1054
WWW.NESSCAMPBELL.COM

Rated Lifting Capacities in Pounds

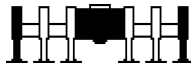

Full

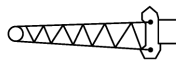

92ft Offset Fly



71,500 lbs



Radius (ft)	Boom Length (ft)											
	Fly Offset											
	44.3				58.9				89.1			
	2°	15°	30°	45°	2°	15°	30°	45°	2°	15°	30°	45°
20	19,800				19,700							
25	18,100				19,200				18,900			
30	16,700				17,700				18,900			
35	15,500	14,400			16,500	15,000			18,300			
40	14,400	13,400			15,400	14,100			17,100	15,100		
45	13,400	12,600	11,900		14,400	13,300			16,200	14,300		
50	12,600	11,800	11,200		13,500	12,500	11,600		15,300	13,600		
55	11,800	11,200	10,600		12,700	11,800	11,000		14,400	12,900	11,700	
60	11,100	10,500	10,000	9,700	12,000	11,200	10,500	10,000	13,700	12,300	11,200	
65	10,500	10,000	9,500	9,300	11,400	10,600	10,000	9,600	13,000	11,800	10,700	
70	9,900	9,500	9,100	8,800	10,800	10,100	9,600	9,200	12,400	11,300	10,300	9,700
75	9,400	9,000	8,700	8,400	10,200	9,600	9,100	8,800	11,800	10,800	9,900	9,300
80	8,900	8,600	8,300	8,100	9,700	9,200	8,700	8,400	11,300	10,400	9,600	9,000
85	8,400	8,100	7,800	7,700	9,300	8,800	8,400	8,100	10,800	9,900	9,200	8,700
90	7,900	7,700	7,400	7,300	8,900	8,400	8,000	7,800	10,300	9,600	8,900	8,400
95	7,400	7,200	7,100	7,000	8,400	8,000	7,700	7,500	9,900	9,200	8,600	8,200
100	7,000	6,800	6,700	6,600	8,000	7,600	7,300	7,200	9,500	8,900	8,300	7,900
105	6,500	6,400	6,300	6,300	7,500	7,200	7,000	6,900	9,200	8,500	8,000	7,700
110	6,100	6,000	6,000	6,000	7,100	6,800	6,600	6,600	8,800	8,200	7,700	7,400
115	5,800	5,700	5,700		6,700	6,500	6,300	6,300	8,400	7,900	7,400	7,200
120	5,400	5,400	5,400		6,300	6,200	6,000	6,000	8,000	7,600	7,200	7,000
125	5,100	5,100			6,000	5,800	5,800		7,700	7,200	6,900	6,700
130					5,700	5,600	5,500		7,300	6,900	6,600	6,500
135					5,400	5,300			7,000	6,600	6,400	6,300
140									6,600	6,300	6,100	6,100
145									6,300	6,100	5,900	5,900
150									6,000	5,800	5,700	
155									5,800	5,600	5,500	
160									5,500	5,400	5,400	
165									5,300	5,200		
Min Angle	0.0	0.0	0.0	0.0	14.5	18.5	28.5	9.5	15.0	18.0	26.0	18.5
Max Rad.	127.9	127.5	124.9	120.1	140.0	140.0	135.0	126.6	170.0	170.0	165.0	156.8
Capacity	3,100	3,100	3,400	3,900	0	0	0	0	0	0	0	0

1051110



PORTLAND OFFICE: 503.283.3111
 SEATTLE OFFICE: 206.784.1054
WWW.NESSCAMPBELL.COM

Rated Lifting Capacities in Pounds

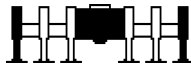

Full

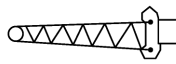

92ft Offset Fly



71,500 lbs



Radius (ft)	Boom Length (ft)											
	Fly Offset											
	120.3				152.4				169.0			
	2°	15°	30°	45°	2°	15°	30°	45°	2°	15°	30°	45°
35	16,500											
40	16,500				13,500							
45	16,500				13,500							
50	16,500	14,500			13,500				12,500			
55	15,900	13,900			13,500				12,500			
60	15,200	13,300			13,500	13,400			12,500			
65	14,500	12,700	11,300		13,500	13,400			12,500	12,400		
70	13,800	12,200	10,900		13,500	13,000			12,500	12,400		
75	13,200	11,800	10,500	9,700	13,500	12,600	11,100		12,500	12,400		
80	12,700	11,300	10,200	9,400	13,500	12,200	10,700		12,500	12,400	10,900	
85	12,200	10,900	9,900	9,200	13,400	11,800	10,400	9,500	12,500	12,100	10,700	
90	11,700	10,500	9,600	8,900	12,900	11,400	10,100	9,300	12,500	11,800	10,400	
95	11,200	10,200	9,300	8,700	12,500	11,000	9,800	9,100	12,500	11,400	10,100	9,200
100	10,800	9,800	9,000	8,400	12,000	10,700	9,600	8,800	12,500	11,100	9,800	9,000
105	10,400	9,500	8,700	8,200	11,600	10,300	9,300	8,600	12,200	10,700	9,600	8,800
110	10,100	9,200	8,500	8,000	11,200	10,000	9,100	8,400	11,800	10,400	9,300	8,600
115	9,700	8,900	8,300	7,800	10,900	9,800	8,800	8,300	11,400	10,100	9,100	8,500
120	9,400	8,600	8,000	7,600	10,500	9,500	8,600	8,100	11,100	9,900	8,900	8,300
125	9,100	8,400	7,700	7,400	10,200	9,200	8,400	7,900	10,700	9,600	8,700	8,100
130	8,800	8,100	7,500	7,200	9,900	9,000	8,200	7,700	10,400	9,300	8,500	7,900
135	8,400	7,800	7,300	7,000	9,600	8,700	8,000	7,500	10,100	9,100	8,300	7,800
140	8,100	7,500	7,100	6,800	9,300	8,500	7,800	7,400	9,800	8,900	8,100	7,600
145	7,800	7,300	6,800	6,600	9,000	8,200	7,600	7,200	9,300	8,700	7,900	7,400
150	7,500	7,000	6,600	6,500	8,800	8,000	7,400	7,000	8,400	8,400	7,700	7,300
155	7,200	6,700	6,400	6,300	8,500	7,800	7,200	6,900	7,700	8,200	7,500	7,100
160	6,900	6,500	6,200	6,100	8,000	7,500	7,000	6,700	6,900	7,800	7,300	7,000
165	6,600	6,300	6,000	6,000	7,400	7,300	6,800	6,600	6,300	7,000	7,200	6,800
170	6,400	6,100	5,900	5,800	6,700	7,100	6,600	6,400	5,600	6,400	7,000	6,700
175	6,100	5,900	5,700		6,100	6,700	6,500	6,300	5,100	5,700	6,400	6,600
180	5,900	5,700	5,500		5,600	6,100	6,300	6,200	4,500	5,100	5,700	6,100
185	5,700	5,500	5,400		5,100	5,600	6,000	6,000	4,000	4,600	5,100	5,500
190	5,500	5,300	5,300		4,600	5,000	5,400	5,600	3,500	4,100	4,600	4,800
195	5,300	5,200			4,100	4,500	4,900	5,000	3,000	3,600	4,000	4,300
200					3,700	4,100	4,400	4,400	2,600	3,100	3,500	3,700
205					3,300	3,600	3,900		2,200	2,600	3,000	3,200
210					2,900	3,200	3,400			2,200	2,600	2,600
215					2,500	2,800	2,900				2,100	
220					2,200	2,400	2,500					
Min Angle	18.0	20.0	26.5	17.0	25.0	26.0	26.0	27.5	40.5	41.0	41.5	41.5
Max Rad.	200.0	200.0	195.0	188.0	222.5	225.0	225.0	220.0	207.5	212.5	216.3	216.3
Capacity	0	0	0	0	0	0	0	0	0	0	0	0

1051110



PORTLAND OFFICE: 503.283.3111
 SEATTLE OFFICE: 206.784.1054
WWW.NESSCAMPBELL.COM

Rated Lifting Capacities in Pounds

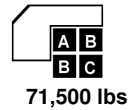
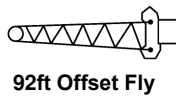
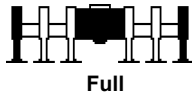

Radius (ft)	Boom Length (ft)			
	Fly Offset			
	185.5			
	2°	15°	30°	45°
50	10,700			
55	10,700			
60	10,700			
65	10,700			
70	10,700	10,600		
75	10,700	10,600		
80	10,700	10,600		
85	10,700	10,600	10,400	
90	10,700	10,600	10,400	
95	10,700	10,600	10,300	
100	10,700	10,600	10,100	9,200
105	10,700	10,600	9,800	9,000
110	10,700	10,600	9,600	8,800
115	10,700	10,500	9,400	8,600
120	10,700	10,200	9,100	8,400
125	10,700	10,000	8,900	8,300
130	10,700	9,700	8,700	8,100
135	10,200	9,500	8,500	8,000
140	9,200	9,200	8,400	7,800
145	8,300	9,000	8,200	7,600
150	7,500	8,500	8,000	7,500
155	6,700	7,700	7,800	7,300
160	6,000	6,900	7,600	7,200
165	5,300	6,200	7,000	7,100
170	4,700	5,500	6,300	6,800
175	4,100	4,900	5,600	6,100
180	3,600	4,300	5,000	5,400
185	3,000	3,700	4,400	4,800
190	2,600	3,200	3,800	4,200
195	2,100	2,700	3,300	3,600
200		2,200	2,800	3,000
205			2,300	2,500
Min Angle	49.5	50.0	50.5	50.5
Max Rad.	196.3	202.5	208.0	210.0
Capacity	0	0	0	0

1051110



PORTLAND OFFICE: 503.283.3111
 SEATTLE OFFICE: 206.784.1054
WWW.NESSCAMPBELL.COM

Rated Lifting Capacities in Pounds

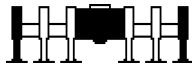

Full

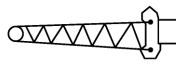

92ft Offset Fly



71,500 lbs



Radius (ft)	Boom Length (ft)											
	Fly Offset											
	44.3				73.5				103.8			
	2°	15°	30°	45°	2°	15°	30°	45°	2°	15°	30°	45°
20	19,800											
25	18,100				17,300							
30	16,700				17,300				15,200			
35	15,500	14,400			17,300				15,200			
40	14,400	13,400			16,300	14,600			15,200			
45	13,400	12,600	11,900		15,300	13,800			15,200	14,700		
50	12,600	11,800	11,200		14,400	13,100			15,200	14,000		
55	11,800	11,200	10,600		13,600	12,400	11,400		15,200	13,400		
60	11,100	10,500	10,000	9,700	12,900	11,800	10,900		14,400	12,800	11,500	
65	10,500	10,000	9,500	9,300	12,200	11,200	10,400	9,800	13,700	12,200	11,000	
70	9,900	9,500	9,100	8,800	11,600	10,700	10,000	9,400	13,100	11,700	10,600	9,800
75	9,400	9,000	8,700	8,400	11,000	10,200	9,500	9,100	12,500	11,300	10,200	9,500
80	8,900	8,600	8,300	8,100	10,500	9,800	9,200	8,700	12,000	10,800	9,900	9,200
85	8,400	8,100	7,800	7,700	10,000	9,400	8,800	8,400	11,500	10,400	9,500	8,900
90	7,900	7,700	7,400	7,300	9,600	9,000	8,500	8,200	11,000	10,000	9,200	8,700
95	7,400	7,200	7,100	7,000	9,200	8,700	8,200	7,900	10,600	9,700	8,900	8,400
100	7,000	6,800	6,700	6,600	8,800	8,300	7,800	7,600	10,200	9,300	8,600	8,200
105	6,500	6,400	6,300	6,300	8,400	7,900	7,500	7,300	9,800	9,000	8,400	8,000
110	6,100	6,000	6,000	6,000	8,000	7,600	7,200	7,000	9,400	8,700	8,100	7,700
115	5,800	5,700	5,700		7,600	7,200	6,900	6,800	9,100	8,400	7,800	7,500
120	5,400	5,400	5,400		7,200	6,900	6,600	6,500	8,800	8,100	7,600	7,300
125	5,100	5,100			6,800	6,500	6,300	6,300	8,400	7,800	7,300	7,100
130					6,500	6,200	6,100	6,100	8,100	7,500	7,100	6,900
135					6,100	6,000	5,800	5,900	7,700	7,200	6,800	6,700
140					5,800	5,700	5,600		7,400	6,900	6,600	6,400
145					5,600	5,500	5,400		7,000	6,700	6,400	6,300
150					5,300	5,200			6,700	6,400	6,200	6,100
155									6,400	6,200	6,000	5,900
160									6,200	5,900	5,800	5,800
165									5,900	5,700	5,600	
170									5,700	5,500	5,400	
175									5,500	5,300	5,300	
180									5,300	5,200		
Min Angle	0.0	0.0	0.0	0.0	14.0	17.0	26.5	26.0	15.5	17.5	25.0	22.5
Max Rad.	127.9	127.5	124.9	120.1	155.0	155.0	150.0	141.2	185.0	185.0	180.0	171.4
Capacity	3,100	3,100	3,400	3,900	0	0	0	0	0	0	0	0

1051120



PORTLAND OFFICE: 503.283.3111
 SEATTLE OFFICE: 206.784.1054
WWW.NESSCAMPBELL.COM

Rated Lifting Capacities in Pounds

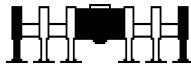

Full

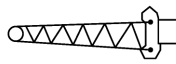

92ft Offset Fly



71,500 lbs



Radius (ft)	Boom Length (ft)											
	Fly Offset											
	119.4				135.4				152.0			
	2°	15°	30°	45°	2°	15°	30°	45°	2°	15°	30°	45°
35	14,900				14,900							
40	14,900				14,900				14,100			
45	14,900				14,900				14,100			
50	14,900	14,500			14,900				14,100			
55	14,900	13,800			14,900	14,200			14,100			
60	14,900	13,300			14,900	13,700			14,100	14,000		
65	14,400	12,700	11,300		14,900	13,100			14,100	13,500		
70	13,800	12,200	10,900		14,500	12,600	11,200		14,100	13,000	11,400	
75	13,200	11,700	10,500	9,700	13,900	12,200	10,800		14,100	12,600	11,100	
80	12,600	11,300	10,200	9,400	13,300	11,700	10,500	9,600	13,900	12,100	10,700	
85	12,100	10,900	9,900	9,200	12,800	11,300	10,100	9,300	13,400	11,700	10,400	9,500
90	11,700	10,500	9,500	8,900	12,300	10,900	9,800	9,100	12,900	11,400	10,100	9,300
95	11,200	10,100	9,300	8,700	11,800	10,600	9,500	8,900	12,500	11,000	9,800	9,100
100	10,800	9,800	9,000	8,400	11,400	10,200	9,300	8,600	12,000	10,700	9,600	8,800
105	10,400	9,500	8,700	8,200	11,000	9,900	9,000	8,400	11,600	10,300	9,300	8,600
110	10,000	9,200	8,500	8,000	10,600	9,600	8,800	8,200	11,200	10,000	9,100	8,400
115	9,700	8,900	8,200	7,800	10,300	9,300	8,500	8,000	10,900	9,700	8,800	8,300
120	9,400	8,600	8,000	7,600	9,900	9,100	8,300	7,800	10,500	9,500	8,600	8,100
125	9,000	8,300	7,700	7,400	9,600	8,800	8,100	7,600	10,200	9,200	8,400	7,900
130	8,700	8,000	7,500	7,200	9,300	8,500	7,900	7,400	9,900	9,000	8,200	7,700
135	8,400	7,800	7,300	7,000	9,000	8,300	7,600	7,300	9,600	8,700	8,000	7,500
140	8,100	7,500	7,100	6,800	8,700	8,000	7,400	7,100	9,300	8,500	7,800	7,300
145	7,800	7,200	6,800	6,600	8,400	7,800	7,200	6,900	9,000	8,200	7,600	7,200
150	7,500	7,000	6,600	6,400	8,100	7,500	7,000	6,800	8,800	8,000	7,400	7,000
155	7,200	6,700	6,400	6,300	7,900	7,300	6,800	6,600	8,500	7,700	7,200	6,900
160	6,900	6,500	6,200	6,100	7,600	7,000	6,600	6,400	8,100	7,500	7,000	6,700
165	6,600	6,200	6,000	6,000	7,300	6,800	6,400	6,300	7,400	7,300	6,800	6,600
170	6,300	6,000	5,800	5,800	7,000	6,500	6,200	6,100	6,800	7,100	6,600	6,400
175	6,100	5,800	5,700		6,700	6,300	6,100	6,000	6,200	6,800	6,400	6,300
180	5,900	5,600	5,500		6,500	6,100	5,900	5,900	5,600	6,200	6,300	6,100
185	5,600	5,500	5,400		6,200	5,900	5,700	5,800	5,100	5,600	6,000	6,000
190	5,400	5,300	5,300		5,900	5,800	5,600		4,600	5,100	5,500	5,600
195	5,300	5,200			5,400	5,600	5,500		4,200	4,600	4,900	5,000
200					5,000	5,200	5,400		3,700	4,100	4,400	4,500
205					4,600	4,800	4,900		3,300	3,700	3,900	
210					4,200	4,300			2,900	3,200	3,400	
215									2,600	2,800	3,000	
220									2,200	2,400	2,500	
225										2,100		
Min Angle	16.5	19.0	25.5	19.5	17.5	19.5	25.5	16.5	24.0	24.0	24.0	14.5
Max Rad. Capacity	200.0	200.0	195.0	187.0	215.0	215.0	210.0	203.1	223.3	226.3	226.0	219.6
	0	0	0	0	0	0	0	0	0	0	0	0

1051120



PORTLAND OFFICE: 503.283.3111
 SEATTLE OFFICE: 206.784.1054
WWW.NESSCAMPBELL.COM

Rated Lifting Capacities in Pounds

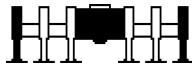

Full

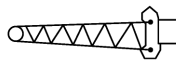

92ft Offset Fly



71,500 lbs



Radius (ft)	Boom Length (ft)			
	Fly Offset			
	168.5			
	2°	15°	30°	45°
45	12,200			
50	12,200			
55	12,200			
60	12,200	12,100		
65	12,200	12,100		
70	12,200	12,100		
75	12,200	12,100		
80	12,200	12,100	10,900	
85	12,200	12,100	10,600	
90	12,200	11,700	10,400	9,400
95	12,200	11,400	10,100	9,200
100	12,200	11,100	9,800	9,000
105	12,200	10,700	9,600	8,800
110	11,800	10,400	9,300	8,600
115	11,400	10,100	9,100	8,400
120	11,100	9,800	8,900	8,300
125	10,700	9,600	8,700	8,100
130	10,400	9,300	8,500	7,900
135	10,100	9,100	8,300	7,800
140	9,800	8,900	8,100	7,600
145	9,300	8,600	7,900	7,400
150	8,500	8,400	7,700	7,300
155	7,700	8,200	7,500	7,100
160	7,000	7,800	7,300	7,000
165	6,300	7,100	7,200	6,800
170	5,700	6,400	7,000	6,700
175	5,100	5,800	6,400	6,500
180	4,600	5,200	5,800	6,100
185	4,000	4,600	5,200	5,500
190	3,500	4,100	4,600	4,900
195	3,100	3,600	4,100	4,300
200	2,600	3,100	3,600	3,700
205	2,200	2,700	3,100	3,200
210		2,300	2,600	2,700
215			2,100	
Min Angle	40.0	40.5	41.0	40.5
Max Rad. Capacity	207.5	213.8	216.3	217.0
	0	0	0	0

1051120



PORTLAND OFFICE: 503.283.3111
 SEATTLE OFFICE: 206.784.1054
WWW.NESSCAMPBELL.COM

Rated Lifting Capacities in Pounds

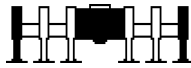

Full

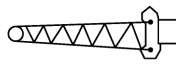

92ft Hydraulic Offset Fly



71,500 lbs



Radius (ft)	Boom Length (ft)											
	Fly Offset											
	44.3			73.5			103.8			134.9		
	2°-15°	15°-30°	30°-45°	2°-15°	15°-30°	30°-45°	2°-15°	15°-30°	30°-45°	2°-15°	15°-30°	30°-45°
20	19,800											
25	18,100			17,300								
30	15,500	15,500		17,300			15,200					
35	14,400	14,400		15,500	15,500		15,200			12,900		
40	13,400	13,400		14,600	14,600		15,200			12,900		
45	12,600	11,900	11,900	13,800	13,800		14,700	14,700		12,900		
50	11,800	11,200	11,200	13,100	11,900	11,900	14,000	14,000		12,800	12,800	
55	11,200	10,600	10,200	12,400	11,400	11,400	13,400	13,400		12,800	12,800	
60	10,500	10,000	9,700	11,800	10,900	10,200	12,800	11,500	11,500	12,800	12,800	
65	10,000	9,500	9,300	11,200	10,400	9,800	12,200	11,000	11,000	12,800	12,800	
70	9,500	9,100	8,800	10,700	10,000	9,400	11,700	10,600	9,800	12,600	11,200	11,200
75	9,000	8,700	8,400	10,200	9,500	9,100	11,300	10,200	9,500	12,200	10,800	10,800
80	8,600	8,300	8,100	9,800	9,200	8,700	10,800	9,900	9,200	11,700	10,500	9,600
85	8,100	7,800	7,700	9,400	8,800	8,400	10,400	9,500	8,900	11,300	10,100	9,300
90	7,700	7,400	7,300	9,000	8,500	8,200	10,000	9,200	8,700	10,900	9,800	9,100
95	7,200	7,100	7,000	8,700	8,200	7,900	9,700	8,900	8,400	10,600	9,500	8,900
100	6,800	6,700	6,600	8,300	7,800	7,600	9,300	8,600	8,200	10,200	9,300	8,600
105	6,400	6,300	6,300	7,900	7,500	7,300	9,000	8,400	8,000	9,900	9,000	8,400
110	6,000	6,000	6,000	7,600	7,200	7,000	8,700	8,100	7,700	9,600	8,800	8,200
115	5,700	5,700	5,700	7,200	6,900	6,800	8,400	7,800	7,500	9,300	8,500	8,000
120	5,400	5,400	5,400	6,900	6,600	6,500	8,100	7,600	7,300	9,000	8,300	7,800
125	5,100	5,100		6,500	6,300	6,300	7,800	7,300	7,100	8,800	8,100	7,600
130				6,200	6,100	6,100	7,500	7,100	6,900	8,500	7,900	7,400
135				6,000	5,800	5,800	7,200	6,800	6,700	8,300	7,600	7,300
140				5,700	5,600	5,600	6,900	6,600	6,400	8,000	7,400	7,100
145				5,500	5,400		6,700	6,400	6,300	7,700	7,200	6,900
150				5,200			6,400	6,200	6,100	7,500	7,000	6,700
155							6,200	6,000	5,900	7,200	6,800	6,600
160							5,900	5,800	5,800	7,000	6,600	6,400
165							5,700	5,600	5,600	6,800	6,400	6,300
170							5,500	5,400	5,400	6,500	6,200	6,100
175							5,300	5,300		6,300	6,000	6,000
180							5,200			6,100	5,900	5,900
185										5,900	5,700	5,700
190										5,500	5,600	5,600
195										5,200	5,400	5,400
200										5,000	5,100	5,100
205										4,700	4,800	
210										4,500		
Min Angle	0.0	0.0	0.0	14.0	26.5	26.0	15.5	25.0	22.5	17.5	26.0	19.5
Max Rad.	127.9	127.5	124.9	155.0	150.0	141.2	185.0	180.0	171.4	215.0	210.0	202.6
Capacity	3,100	3,100	3,400	0	0	0	0	0	0	0	0	0

1052100



PORTLAND OFFICE: 503.283.3111
 SEATTLE OFFICE: 206.784.1054
WWW.NESSCAMPBELL.COM

Rated Lifting Capacities in Pounds

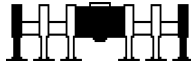

Full

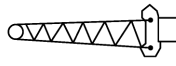

92ft Hydraulic Offset Fly



71,500 lbs



		Boom Length (ft)								
		Fly Offset								
Radius (ft)	167.1			183.6			200.1			
	2°-15°	15°-30°	30°-45°	2°-15°	15°-30°	30°-45°	2°-15°	15°-30°	30°-45°	
45	10,400									
50	10,400			9,600						
55	10,300	10,300		9,600			8,200			
60	10,300	10,300		9,500	9,500		8,200			
65	10,300	10,300		9,500	9,500		8,100	8,100		
70	10,300	10,300		9,500	9,500		8,100	8,100		
75	10,300	10,200	10,200	9,500	9,500		8,100	8,100		
80	10,300	10,200	10,200	9,500	9,400	9,400	8,100	8,100		
85	10,300	10,200	9,600	9,500	9,400	9,400	8,100	8,000	8,000	
90	10,300	10,200	9,400	9,500	9,400	9,200	8,100	8,000	8,000	
95	10,300	10,100	9,200	9,500	9,400	9,200	8,100	8,000	7,800	
100	10,300	9,800	9,000	9,500	9,400	9,100	8,100	8,000	7,800	
105	10,300	9,500	8,800	9,500	9,400	9,000	8,100	8,000	7,800	
110	10,300	9,300	8,600	9,500	9,400	8,800	8,100	8,000	7,800	
115	10,100	9,100	8,400	9,500	9,300	8,600	8,100	8,000	7,800	
120	9,800	8,900	8,300	9,500	9,100	8,400	8,100	8,000	7,800	
125	9,600	8,700	8,100	9,500	8,900	8,300	8,100	8,000	7,800	
130	9,300	8,500	7,900	9,500	8,700	8,100	8,100	8,000	7,800	
135	9,100	8,300	7,700	9,400	8,500	8,000	8,100	8,000	7,800	
140	8,800	8,100	7,600	9,200	8,300	7,800	8,100	8,000	7,800	
145	8,600	7,900	7,400	9,000	8,200	7,600	8,100	8,000	7,800	
150	8,400	7,700	7,200	8,600	8,000	7,500	7,700	8,000	7,700	
155	8,200	7,500	7,100	7,800	7,800	7,300	6,900	7,900	7,500	
160	7,800	7,300	7,000	7,100	7,600	7,200	6,200	7,100	7,400	
165	7,300	7,100	6,800	6,400	7,200	7,000	5,500	6,400	7,200	
170	6,800	7,000	6,700	5,800	6,600	6,900	4,900	5,700	6,500	
175	6,200	6,800	6,500	5,200	5,900	6,600	4,300	5,100	5,900	
180	5,700	6,300	6,400	4,700	5,300	6,000	3,800	4,500	5,200	
185	5,200	5,700	6,200	4,100	4,800	5,400	3,200	4,000	4,600	
190	4,700	5,200	5,600	3,700	4,300	4,800	2,700	3,400	4,100	
195	4,200	4,700	5,100	3,200	3,800	4,300	2,300	2,900	3,500	
200	3,800	4,200	4,600	2,800	3,300	3,800		2,500	3,000	
205	3,400	3,800	4,100	2,300	2,800	3,300			2,500	
210	3,000	3,300	3,600		2,400	2,800			2,100	
215	2,600	2,900	3,200			2,400				
220	2,200	2,600	2,800							
225		2,200	2,300							
Min Angle	34.0	34.0	33.5	45.5	46.0	46.5	53.0	53.5	53.5	
Max Rad. Capacity	223.3	227.5	228.0	208.8	215.0	219.0	198.0	205.0	211.0	
	0	0	0	0	0	0	0	0	0	

1052100



PORTLAND OFFICE: 503.283.3111
 SEATTLE OFFICE: 206.784.1054
WWW.NESSCAMPBELL.COM

Rated Lifting Capacities in Pounds

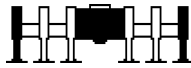

Full

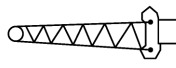

92ft Hydraulic Offset Fly



71,500 lbs



Radius (ft)	Boom Length (ft)											
	Fly Offset											
	44.3			58.9			89.1			120.3		
	2°-15°	15°-30°	30°-45°	2°-15°	15°-30°	30°-45°	2°-15°	15°-30°	30°-45°	2°-15°	15°-30°	30°-45°
20	19,800			19,700								
25	18,100			19,200			18,900					
30	15,500	15,500		16,000	16,000		18,900					
35	14,400	14,400		15,000	15,000		18,300			16,500		
40	13,400	13,400		14,100	14,100		15,100	15,100		16,500		
45	12,600	11,900	11,900	13,300	12,200	12,200	14,300	14,300		16,500		
50	11,800	11,200	11,200	12,500	11,600	11,600	13,600	13,600		14,500	14,500	
55	11,200	10,600	10,200	11,800	11,000	11,000	12,900	11,700	11,700	13,900	13,900	
60	10,500	10,000	9,700	11,200	10,500	10,000	12,300	11,200	11,200	13,300	11,700	11,700
65	10,000	9,500	9,300	10,600	10,000	9,600	11,800	10,700	10,000	12,700	11,300	11,300
70	9,500	9,100	8,800	10,100	9,600	9,200	11,300	10,300	9,700	12,200	10,900	10,000
75	9,000	8,700	8,400	9,600	9,100	8,800	10,800	9,900	9,300	11,800	10,500	9,700
80	8,600	8,300	8,100	9,200	8,700	8,400	10,400	9,600	9,000	11,300	10,200	9,400
85	8,100	7,800	7,700	8,800	8,400	8,100	9,900	9,200	8,700	10,900	9,900	9,200
90	7,700	7,400	7,300	8,400	8,000	7,800	9,600	8,900	8,400	10,500	9,600	8,900
95	7,200	7,100	7,000	8,000	7,700	7,500	9,200	8,600	8,200	10,200	9,300	8,700
100	6,800	6,700	6,600	7,600	7,300	7,200	8,900	8,300	7,900	9,800	9,000	8,400
105	6,400	6,300	6,300	7,200	7,000	6,900	8,500	8,000	7,700	9,500	8,700	8,200
110	6,000	6,000	6,000	6,800	6,600	6,600	8,200	7,700	7,400	9,200	8,500	8,000
115	5,700	5,700	5,700	6,500	6,300	6,300	7,900	7,400	7,200	8,900	8,300	7,800
120	5,400	5,400	5,400	6,200	6,000	6,000	7,600	7,200	7,000	8,600	8,000	7,600
125	5,100	5,100		5,800	5,800	5,800	7,200	6,900	6,700	8,400	7,700	7,400
130				5,600	5,500		6,900	6,600	6,500	8,100	7,500	7,200
135				5,300			6,600	6,400	6,300	7,800	7,300	7,000
140							6,300	6,100	6,100	7,500	7,100	6,800
145							6,100	5,900	5,900	7,300	6,800	6,600
150							5,800	5,700	5,700	7,000	6,600	6,500
155							5,600	5,500	5,500	6,700	6,400	6,300
160							5,400	5,400		6,500	6,200	6,100
165							5,200			6,300	6,000	6,000
170										6,100	5,900	5,800
175										5,900	5,700	5,700
180										5,700	5,500	5,500
185										5,500	5,400	5,400
190										5,300	5,300	
195										5,200		
Min Angle	0.0	0.0	0.0	14.5	28.5	9.5	15.0	26.0	18.5	18.0	26.5	17.0
Max Rad. Capacity	127.9	127.5	124.9	140.0	135.0	126.6	170.0	165.0	156.8	200.0	195.0	188.0
	3,100	3,100	3,400	0	0	0	0	0	0	0	0	0

1052110



PORTLAND OFFICE: 503.283.3111
 SEATTLE OFFICE: 206.784.1054
WWW.NESSCAMPBELL.COM

Rated Lifting Capacities in Pounds

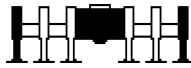

Full

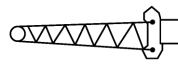

92ft Hydraulic Offset Fly



71,500 lbs



Radius (ft)	Boom Length (ft)								
	Fly Offset								
	152.4			169.0			185.5		
	2°-15°	15°-30°	30°-45°	2°-15°	15°-30°	30°-45°	2°-15°	15°-30°	30°-45°
40	13,500								
45	13,500								
50	13,500			12,500			10,700		
55	13,300	13,300		12,500			10,700		
60	13,300	13,300		12,400	12,400		10,700		
65	13,300	13,300		12,400	12,400		10,600	10,600	
70	13,000	11,400	11,400	12,400	12,400		10,600	10,600	
75	12,600	11,100	11,100	12,400	11,300	11,300	10,600	10,600	
80	12,200	10,700	9,800	12,400	10,900	10,900	10,600	10,400	10,400
85	11,800	10,400	9,500	12,100	10,700	10,700	10,600	10,400	10,400
90	11,400	10,100	9,300	11,800	10,400	9,400	10,600	10,400	10,400
95	11,000	9,800	9,100	11,400	10,100	9,200	10,600	10,300	9,400
100	10,700	9,600	8,800	11,100	9,800	9,000	10,600	10,100	9,200
105	10,300	9,300	8,600	10,700	9,600	8,800	10,600	9,800	9,000
110	10,000	9,100	8,400	10,400	9,300	8,600	10,600	9,600	8,800
115	9,800	8,800	8,300	10,100	9,100	8,500	10,500	9,400	8,600
120	9,500	8,600	8,100	9,900	8,900	8,300	10,200	9,100	8,400
125	9,200	8,400	7,900	9,600	8,700	8,100	10,000	8,900	8,300
130	9,000	8,200	7,700	9,300	8,500	7,900	9,700	8,700	8,100
135	8,700	8,000	7,500	9,100	8,300	7,800	9,500	8,500	8,000
140	8,500	7,800	7,400	8,900	8,100	7,600	9,200	8,400	7,800
145	8,200	7,600	7,200	8,700	7,900	7,400	8,300	8,200	7,600
150	8,000	7,400	7,000	8,400	7,700	7,300	7,500	8,000	7,500
155	7,800	7,200	6,900	7,700	7,500	7,100	6,700	7,700	7,300
160	7,500	7,000	6,700	6,900	7,300	7,000	6,000	6,900	7,200
165	7,300	6,800	6,600	6,300	7,000	6,800	5,300	6,200	7,000
170	6,700	6,600	6,400	5,600	6,400	6,700	4,700	5,500	6,300
175	6,100	6,500	6,300	5,100	5,700	6,400	4,100	4,900	5,600
180	5,600	6,100	6,200	4,500	5,100	5,700	3,600	4,300	5,000
185	5,100	5,600	6,000	4,000	4,600	5,100	3,000	3,700	4,400
190	4,600	5,000	5,400	3,500	4,100	4,600	2,600	3,200	3,800
195	4,100	4,500	4,900	3,000	3,600	4,000	2,100	2,700	3,300
200	3,700	4,100	4,400	2,600	3,100	3,500		2,200	2,800
205	3,300	3,600	3,900	2,200	2,600	3,000			2,300
210	2,900	3,200	3,300		2,200	2,600			
215	2,500	2,800	2,800			2,100			
220	2,200	2,400							
Min Angle	25.0	26.0	27.5	40.5	41.0	41.5	49.5	50.0	50.5
Max Rad. Capacity	222.5	225.0	220.0	207.5	212.5	216.3	196.3	202.5	208.0
	0	0	0	0	0	0	0	0	0

1052110



PORTLAND OFFICE: 503.283.3111
 SEATTLE OFFICE: 206.784.1054
WWW.NESSCAMPBELL.COM

Rated Lifting Capacities in Pounds

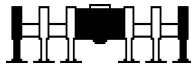

Full

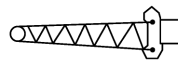

92ft Hydraulic Offset Fly



71,500 lbs



Radius (ft)	Boom Length (ft)											
	Fly Offset											
	44.3			73.5			103.8			119.4		
	2°-15°	15°-30°	30°-45°	2°-15°	15°-30°	30°-45°	2°-15°	15°-30°	30°-45°	2°-15°	15°-30°	30°-45°
20	19,800											
25	18,100			17,300								
30	15,500	15,500		17,300			15,200					
35	14,400	14,400		15,500	15,500		15,200			14,900		
40	13,400	13,400		14,600	14,600		15,200			14,900		
45	12,600	11,900	11,900	13,800	13,800		14,700	14,700		14,900		
50	11,800	11,200	11,200	13,100	11,900	11,900	14,000	14,000		14,500	14,500	
55	11,200	10,600	10,200	12,400	11,400	11,400	13,400	13,400		13,800	13,800	
60	10,500	10,000	9,700	11,800	10,900	10,200	12,800	11,500	11,500	13,300	13,300	
65	10,000	9,500	9,300	11,200	10,400	9,800	12,200	11,000	11,000	12,700	11,300	11,300
70	9,500	9,100	8,800	10,700	10,000	9,400	11,700	10,600	9,800	12,200	10,900	10,900
75	9,000	8,700	8,400	10,200	9,500	9,100	11,300	10,200	9,500	11,700	10,500	9,700
80	8,600	8,300	8,100	9,800	9,200	8,700	10,800	9,900	9,200	11,300	10,200	9,400
85	8,100	7,800	7,700	9,400	8,800	8,400	10,400	9,500	8,900	10,900	9,900	9,200
90	7,700	7,400	7,300	9,000	8,500	8,200	10,000	9,200	8,700	10,500	9,500	8,900
95	7,200	7,100	7,000	8,700	8,200	7,900	9,700	8,900	8,400	10,100	9,300	8,700
100	6,800	6,700	6,600	8,300	7,800	7,600	9,300	8,600	8,200	9,800	9,000	8,400
105	6,400	6,300	6,300	7,900	7,500	7,300	9,000	8,400	8,000	9,500	8,700	8,200
110	6,000	6,000	6,000	7,600	7,200	7,000	8,700	8,100	7,700	9,200	8,500	8,000
115	5,700	5,700	5,700	7,200	6,900	6,800	8,400	7,800	7,500	8,900	8,200	7,800
120	5,400	5,400	5,400	6,900	6,600	6,500	8,100	7,600	7,300	8,600	8,000	7,600
125	5,100	5,100		6,500	6,300	6,300	7,800	7,300	7,100	8,300	7,700	7,400
130				6,200	6,100	6,100	7,500	7,100	6,900	8,000	7,500	7,200
135				6,000	5,800	5,800	7,200	6,800	6,700	7,800	7,300	7,000
140				5,700	5,600	5,600	6,900	6,600	6,400	7,500	7,100	6,800
145				5,500	5,400		6,700	6,400	6,300	7,200	6,800	6,600
150				5,200			6,400	6,200	6,100	7,000	6,600	6,400
155							6,200	6,000	5,900	6,700	6,400	6,300
160							5,900	5,800	5,800	6,500	6,200	6,100
165							5,700	5,600	5,600	6,200	6,000	6,000
170							5,500	5,400	5,400	6,000	5,800	5,800
175							5,300	5,300		5,800	5,700	5,700
180							5,200			5,600	5,500	5,500
185										5,500	5,400	5,400
190										5,300	5,300	
195										5,200		
Min Angle	0.0	0.0	0.0	14.0	26.5	26.0	15.5	25.0	22.5	16.5	25.5	19.5
Max Rad. Capacity	127.9	127.5	124.9	155.0	150.0	141.2	185.0	180.0	171.4	200.0	195.0	187.0
	3,100	3,100	3,400	0	0	0	0	0	0	0	0	0

1052120



PORTLAND OFFICE: 503.283.3111
 SEATTLE OFFICE: 206.784.1054
WWW.NESSCAMPBELL.COM

Rated Lifting Capacities in Pounds

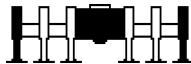

Full

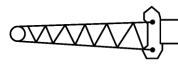

92ft Hydraulic Offset Fly



71,500 lbs



Radius (ft)	Boom Length (ft)								
	Fly Offset								
	135.4			152.0			168.5		
	2°-15°	15°-30°	30°-45°	2°-15°	15°-30°	30°-45°	2°-15°	15°-30°	30°-45°
35	14,900								
40	14,900			14,100					
45	14,900			14,100			12,200		
50	14,900			14,100			12,200		
55	14,200	14,200		14,000	14,000		12,200		
60	13,700	13,700		14,000	14,000		12,100	12,100	
65	13,100	11,500	11,500	13,500	13,500		12,100	12,100	
70	12,600	11,200	11,200	13,000	11,400	11,400	12,100	12,100	
75	12,200	10,800	9,900	12,600	11,100	11,100	12,100	11,300	11,300
80	11,700	10,500	9,600	12,100	10,700	9,800	12,100	10,900	10,900
85	11,300	10,100	9,300	11,700	10,400	9,500	12,100	10,600	9,700
90	10,900	9,800	9,100	11,400	10,100	9,300	11,700	10,400	9,400
95	10,600	9,500	8,900	11,000	9,800	9,100	11,400	10,100	9,200
100	10,200	9,300	8,600	10,700	9,600	8,800	11,100	9,800	9,000
105	9,900	9,000	8,400	10,300	9,300	8,600	10,700	9,600	8,800
110	9,600	8,800	8,200	10,000	9,100	8,400	10,400	9,300	8,600
115	9,300	8,500	8,000	9,700	8,800	8,300	10,100	9,100	8,400
120	9,100	8,300	7,800	9,500	8,600	8,100	9,800	8,900	8,300
125	8,800	8,100	7,600	9,200	8,400	7,900	9,600	8,700	8,100
130	8,500	7,900	7,400	9,000	8,200	7,700	9,300	8,500	7,900
135	8,300	7,600	7,300	8,700	8,000	7,500	9,100	8,300	7,800
140	8,000	7,400	7,100	8,500	7,800	7,300	8,900	8,100	7,600
145	7,800	7,200	6,900	8,200	7,600	7,200	8,600	7,900	7,400
150	7,500	7,000	6,800	8,000	7,400	7,000	8,400	7,700	7,300
155	7,300	6,800	6,600	7,700	7,200	6,900	7,700	7,500	7,100
160	7,000	6,600	6,400	7,500	7,000	6,700	7,000	7,300	7,000
165	6,800	6,400	6,300	7,300	6,800	6,600	6,300	7,100	6,800
170	6,500	6,200	6,100	6,800	6,600	6,400	5,700	6,400	6,700
175	6,300	6,100	6,000	6,200	6,400	6,300	5,100	5,800	6,400
180	6,100	5,900	5,900	5,600	6,200	6,100	4,600	5,200	5,800
185	5,900	5,700	5,700	5,100	5,600	6,000	4,000	4,600	5,200
190	5,800	5,600	5,600	4,600	5,100	5,500	3,500	4,100	4,600
195	5,400	5,500	5,500	4,200	4,600	4,900	3,100	3,600	4,100
200	5,000	5,200	5,300	3,700	4,100	4,400	2,600	3,100	3,600
205	4,600	4,800		3,300	3,700	3,900	2,200	2,700	3,100
210	4,200			2,900	3,200	3,400		2,300	2,600
215				2,600	2,800	2,800			2,100
220				2,200	2,400				
225					2,100				
Min Angle	17.5	25.5	16.5	24.0	24.0	14.5	40.0	40.5	41.0
Max Rad. Capacity	215.0	210.0	203.1	223.3	226.0	219.6	207.5	213.8	216.3
	0	0	0	0	0	0	0	0	0

1052120



PORTLAND OFFICE: 503.283.3111
 SEATTLE OFFICE: 206.784.1054
WWW.NESSCAMPBELL.COM

Rated Lifting Capacities in Pounds

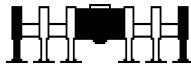

Full

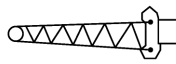

117ft Offset Fly



71,500 lbs



Radius (ft)	Boom Length (ft)											
	Fly Offset											
	44.3				73.5				103.8			
	2°	15°	30°	45°	2°	15°	30°	45°	2°	15°	30°	45°
25	15,800											
30	14,500				14,800							
35	13,300				14,800				13,100			
40	12,300	11,900			13,800				13,100			
45	11,400	11,000			12,900	12,000			13,100			
50	10,600	10,300	10,000		12,100	11,300			13,100			
55	9,900	9,600	9,400		11,300	10,700			12,600	11,500		
60	9,200	9,000	8,800		10,600	10,000	9,500		11,900	10,900		
65	8,600	8,400	8,300	8,200	10,000	9,500	9,000		11,300	10,400		
70	8,100	7,900	7,800	7,800	9,400	9,000	8,600	8,300	10,700	9,900	9,200	
75	7,600	7,500	7,400	7,300	8,900	8,500	8,200	7,900	10,100	9,400	8,800	
80	7,000	6,900	6,900	6,900	8,400	8,100	7,800	7,600	9,600	9,000	8,400	8,000
85	6,600	6,500	6,400	6,400	8,000	7,700	7,400	7,200	9,100	8,500	8,000	7,700
90	6,100	6,100	6,000	6,000	7,500	7,200	7,000	6,800	8,700	8,200	7,700	7,400
95	5,600	5,600	5,600	5,700	7,100	6,800	6,600	6,500	8,300	7,800	7,400	7,100
100	5,200	5,200	5,300	5,300	6,700	6,400	6,200	6,100	7,900	7,500	7,000	6,800
105	4,800	4,900	4,900	4,900	6,300	6,100	5,900	5,800	7,500	7,100	6,700	6,500
110	4,500	4,500	4,600	4,600	5,900	5,700	5,600	5,500	7,100	6,700	6,400	6,200
115	4,200	4,200	4,200	4,300	5,500	5,400	5,300	5,200	6,800	6,400	6,100	5,900
120	3,900	3,900	3,900	4,000	5,200	5,000	5,000	4,900	6,400	6,100	5,800	5,700
125	3,600	3,600	3,700	3,700	4,800	4,700	4,700	4,700	6,100	5,800	5,600	5,400
130	3,300	3,400	3,400	3,500	4,500	4,500	4,400	4,400	5,700	5,500	5,300	5,200
135	3,100	3,100	3,200		4,300	4,200	4,200	4,200	5,400	5,200	5,000	4,900
140	2,900	2,900	2,900		4,000	3,900	3,900	3,900	5,100	4,900	4,800	4,700
145	2,600	2,700			3,700	3,700	3,700	3,700	4,800	4,700	4,500	4,500
150	2,500	2,500			3,500	3,500	3,500	3,500	4,600	4,400	4,300	4,300
155					3,300	3,300	3,300	3,300	4,300	4,200	4,100	4,100
160					3,100	3,100	3,100		4,100	4,000	3,900	3,900
165					2,900	2,900	2,900		3,900	3,800	3,700	3,700
170					2,700	2,700	2,700		3,700	3,600	3,500	3,600
175					2,600	2,600			3,500	3,400	3,400	3,400
180									3,300	3,200	3,200	3,200
185									3,100	3,100	3,100	
190									3,000	2,900	2,900	
195									2,800	2,800	2,800	
200									2,700	2,600	2,700	
205									2,500	2,500		
Min Angle	0.0	0.0	0.0	0.0	13.5	16.0	24.0	29.5	15.0	17.0	23.5	27.5
Max Rad. Capacity	152.9	152.4	149.4	144.0	180.0	180.0	175.0	166.2	210.0	210.0	205.0	196.4
	2,400	2,400	2,500	2,700	0	0	0	0	0	0	0	0

1051130



PORTLAND OFFICE: 503.283.3111
 SEATTLE OFFICE: 206.784.1054
WWW.NESSCAMPBELL.COM

Rated Lifting Capacities in Pounds

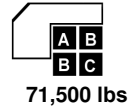
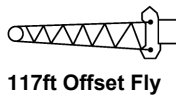
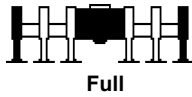

Radius (ft)	Boom Length (ft)											
	Fly Offset											
	134.9				167.1				183.6			
	2°	15°	30°	45°	2°	15°	30°	45°	2°	15°	30°	45°
45	11,000											
50	11,000				8,600							
55	11,000				8,600							
60	11,000				8,600				7,900			
65	11,000	10,900			8,600				7,900			
70	11,000	10,600			8,600	8,500			7,900			
75	11,000	10,200			8,600	8,500			7,900	7,800		
80	10,700	9,700	8,900		8,600	8,500			7,900	7,800		
85	10,200	9,300	8,600		8,600	8,500			7,900	7,800		
90	9,800	8,900	8,300	7,800	8,600	8,500	8,400		7,900	7,800		
95	9,300	8,600	8,000	7,500	8,600	8,500	8,400		7,900	7,800	7,700	
100	8,900	8,200	7,700	7,300	8,600	8,500	8,200	7,600	7,900	7,800	7,700	
105	8,600	7,900	7,400	7,000	8,600	8,500	7,900	7,400	7,900	7,800	7,700	7,500
110	8,200	7,600	7,100	6,700	8,600	8,300	7,600	7,200	7,900	7,800	7,700	7,400
115	7,900	7,300	6,800	6,500	8,600	8,000	7,400	6,900	7,900	7,800	7,600	7,200
120	7,500	7,000	6,500	6,200	8,500	7,800	7,100	6,700	7,900	7,800	7,400	6,900
125	7,200	6,700	6,300	6,000	8,200	7,500	6,900	6,500	7,900	7,800	7,200	6,700
130	6,900	6,400	6,000	5,800	7,900	7,200	6,600	6,300	7,900	7,600	6,900	6,500
135	6,600	6,100	5,800	5,600	7,600	6,900	6,400	6,100	7,900	7,300	6,700	6,300
140	6,300	5,900	5,500	5,400	7,300	6,700	6,200	5,900	7,700	7,000	6,500	6,100
145	6,000	5,600	5,300	5,100	7,000	6,400	6,000	5,700	7,400	6,800	6,200	5,900
150	5,700	5,300	5,100	4,900	6,700	6,200	5,700	5,500	7,100	6,500	6,000	5,700
155	5,400	5,100	4,900	4,700	6,400	5,900	5,500	5,300	6,900	6,300	5,800	5,600
160	5,100	4,900	4,700	4,500	6,200	5,700	5,300	5,100	6,600	6,100	5,600	5,400
165	4,900	4,600	4,500	4,400	5,900	5,500	5,100	4,900	6,300	5,900	5,400	5,200
170	4,600	4,400	4,300	4,200	5,600	5,200	4,900	4,800	5,600	5,600	5,200	5,000
175	4,400	4,200	4,100	4,000	5,400	5,000	4,700	4,600	5,000	5,400	5,100	4,900
180	4,200	4,000	3,900	3,900	5,100	4,800	4,600	4,400	4,500	5,200	4,900	4,700
185	4,000	3,900	3,800	3,700	4,800	4,600	4,400	4,300	4,000	4,700	4,700	4,600
190	3,800	3,700	3,600	3,600	4,500	4,400	4,200	4,100	3,500	4,100	4,500	4,400
195	3,700	3,500	3,500	3,500	4,000	4,300	4,100	4,000	3,000	3,600	4,200	4,300
200	3,500	3,400	3,300	3,300	3,500	4,100	3,900	3,900	2,500	3,200	3,700	4,100
205	3,300	3,200	3,200	3,200	3,100	3,600	3,800	3,700	2,100	2,700	3,200	3,500
210	3,200	3,100	3,100		2,700	3,200	3,600	3,600		2,300	2,800	3,100
215	3,000	3,000	2,900		2,400	2,800	3,200	3,300			2,300	2,600
220	2,900	2,800	2,800			2,400	2,700	2,900				2,100
225	2,700	2,700	2,700				2,300	2,400				
230	2,500	2,600	2,600									
235	2,400	2,400										
Min Angle	18.0	20.0	25.0	26.0	45.5	46.0	46.0	46.0	53.0	53.5	54.0	53.5
Max Rad. Capacity	240.0	240.0	235.0	227.6	220.0	225.0	230.0	230.0	206.3	213.8	218.8	221.3
	0	0	0	0	0	0	0	0	0	0	0	0

1051130



PORTLAND OFFICE: 503.283.3111
 SEATTLE OFFICE: 206.784.1054
WWW.NESSCAMPBELL.COM

Rated Lifting Capacities in Pounds

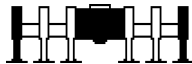

Full

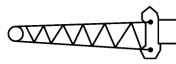

117ft Offset Fly

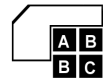

71,500 lbs



Radius (ft)	Boom Length (ft)			
	Fly Offset			
	200.1			
	2°	15°	30°	45°
60	6,700			
65	6,700			
70	6,700			
75	6,700			
80	6,700	6,600		
85	6,700	6,600		
90	6,700	6,600		
95	6,700	6,600	6,400	
100	6,700	6,600	6,400	
105	6,700	6,600	6,400	
110	6,700	6,600	6,400	6,300
115	6,700	6,600	6,400	6,300
120	6,700	6,600	6,400	6,300
125	6,700	6,600	6,400	6,300
130	6,700	6,600	6,400	6,300
135	6,700	6,600	6,400	6,300
140	6,700	6,600	6,400	6,300
145	6,700	6,600	6,400	6,100
150	6,700	6,600	6,300	5,900
155	6,700	6,600	6,100	5,800
160	6,100	6,400	5,900	5,600
165	5,400	6,200	5,700	5,400
170	4,700	5,600	5,500	5,300
175	4,100	5,000	5,400	5,100
180	3,600	4,400	5,200	4,900
185	3,100	3,800	4,600	4,800
190	2,600	3,300	4,000	4,500
195	2,100	2,800	3,500	3,900
200		2,300	3,000	3,400
205			2,500	2,900
210				2,400
Min Angle	58.5	59.5	60.0	60.0
Max Rad.	196.3	203.8	210.0	214.0
Capacity	0	0	0	0

1051130



PORTLAND OFFICE: 503.283.3111
 SEATTLE OFFICE: 206.784.1054
WWW.NESSCAMPBELL.COM

Rated Lifting Capacities in Pounds

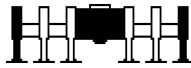

Full

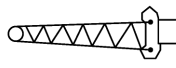

117ft Offset Fly



71,500 lbs



Radius (ft)	Boom Length (ft)											
	Fly Offset											
	44.3				58.9				89.1			
	2°	15°	30°	45°	2°	15°	30°	45°	2°	15°	30°	45°
25	15,800				16,400							
30	14,500				15,300							
35	13,300				14,100				15,600			
40	12,300	11,900			13,100	12,400			14,500			
45	11,400	11,000			12,200	11,600			13,600			
50	10,600	10,300	10,000		11,400	10,800			12,800	11,800		
55	9,900	9,600	9,400		10,600	10,200	9,800		12,000	11,100		
60	9,200	9,000	8,800		10,000	9,600	9,200		11,300	10,500		
65	8,600	8,400	8,300	8,200	9,400	9,000	8,700	8,500	10,700	10,000	9,400	
70	8,100	7,900	7,800	7,800	8,800	8,500	8,200	8,100	10,100	9,500	8,900	
75	7,600	7,500	7,400	7,300	8,300	8,000	7,800	7,700	9,600	9,000	8,500	8,200
80	7,000	6,900	6,900	6,900	7,800	7,600	7,400	7,300	9,100	8,500	8,100	7,800
85	6,600	6,500	6,400	6,400	7,300	7,100	6,900	6,900	8,600	8,100	7,700	7,500
90	6,100	6,100	6,000	6,000	6,800	6,700	6,500	6,500	8,200	7,800	7,400	7,200
95	5,600	5,600	5,600	5,700	6,400	6,300	6,200	6,100	7,800	7,400	7,000	6,800
100	5,200	5,200	5,300	5,300	6,000	5,900	5,800	5,800	7,300	7,000	6,700	6,500
105	4,800	4,900	4,900	4,900	5,600	5,500	5,400	5,400	6,900	6,600	6,300	6,200
110	4,500	4,500	4,600	4,600	5,200	5,100	5,100	5,100	6,600	6,300	6,000	5,900
115	4,200	4,200	4,200	4,300	4,800	4,800	4,800	4,800	6,200	6,000	5,700	5,600
120	3,900	3,900	3,900	4,000	4,500	4,500	4,500	4,500	5,800	5,600	5,400	5,300
125	3,600	3,600	3,700	3,700	4,200	4,200	4,200	4,200	5,500	5,300	5,200	5,100
130	3,300	3,400	3,400	3,500	3,900	3,900	3,900	4,000	5,200	5,000	4,900	4,800
135	3,100	3,100	3,200		3,700	3,700	3,700	3,700	4,900	4,700	4,600	4,600
140	2,900	2,900	2,900		3,400	3,400	3,500	3,500	4,600	4,500	4,400	4,400
145	2,600	2,700			3,200	3,200	3,200		4,300	4,200	4,200	4,100
150	2,500	2,500			3,000	3,000	3,000		4,100	4,000	3,900	3,900
155					2,800	2,800	2,800		3,800	3,800	3,700	3,700
160					2,600	2,600			3,600	3,600	3,500	3,500
165									3,400	3,400	3,400	3,400
170									3,200	3,200	3,200	
175									3,000	3,000	3,000	
180									2,900	2,900	2,900	
185									2,700	2,700	2,700	
190									2,600	2,600		
Min Angle	0.0	0.0	0.0	0.0	14.0	17.0	25.5	30.0	14.5	17.0	24.0	27.0
Max Rad. Capacity	152.9	152.4	149.4	144.0	165.0	165.0	160.0	151.6	195.0	195.0	190.0	181.8
	2,400	2,400	2,500	2,700	0	0	0	0	0	0	0	0

1051140



PORTLAND OFFICE: 503.283.3111
 SEATTLE OFFICE: 206.784.1054
WWW.NESSCAMPBELL.COM

Rated Lifting Capacities in Pounds

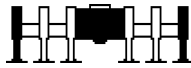

Full

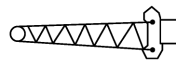

117ft Offset Fly



71,500 lbs



Radius (ft)	Boom Length (ft)											
	Fly Offset											
	120.3				152.4				169.0			
	2°	15°	30°	45°	2°	15°	30°	45°	2°	15°	30°	45°
40	14,400											
45	14,400											
50	14,000				11,500							
55	13,200				11,500				10,600			
60	12,500	11,300			11,500				10,600			
65	11,900	10,800			11,500	11,400			10,600			
70	11,300	10,300	9,500		11,500	11,000			10,600			
75	10,700	9,800	9,100		11,500	10,600			10,600	10,500		
80	10,200	9,400	8,700	8,200	11,300	10,100	9,200		10,600	10,500		
85	9,700	9,000	8,300	7,900	10,800	9,700	8,900		10,600	10,100		
90	9,300	8,600	8,000	7,600	10,300	9,300	8,500	8,000	10,600	9,700	8,800	
95	8,900	8,200	7,700	7,400	9,900	9,000	8,200	7,700	10,400	9,300	8,500	
100	8,500	7,900	7,400	7,100	9,500	8,600	8,000	7,500	9,900	9,000	8,200	7,700
105	8,100	7,600	7,100	6,800	9,100	8,300	7,700	7,300	9,600	8,700	7,900	7,400
110	7,800	7,200	6,800	6,500	8,700	8,000	7,400	7,000	9,200	8,400	7,700	7,200
115	7,400	6,900	6,500	6,200	8,400	7,700	7,100	6,700	8,900	8,100	7,400	7,000
120	7,000	6,600	6,200	6,000	8,100	7,400	6,900	6,500	8,500	7,800	7,200	6,700
125	6,700	6,300	6,000	5,800	7,800	7,100	6,600	6,300	8,200	7,500	6,900	6,500
130	6,400	6,000	5,700	5,500	7,400	6,800	6,400	6,100	7,900	7,200	6,700	6,300
135	6,100	5,700	5,400	5,300	7,100	6,600	6,100	5,900	7,600	7,000	6,400	6,100
140	5,700	5,400	5,200	5,100	6,800	6,300	5,900	5,700	7,300	6,700	6,200	5,900
145	5,400	5,200	5,000	4,800	6,500	6,100	5,700	5,500	7,000	6,400	6,000	5,700
150	5,200	4,900	4,700	4,600	6,300	5,800	5,500	5,300	6,700	6,200	5,800	5,500
155	4,900	4,700	4,500	4,400	6,000	5,600	5,200	5,100	6,500	6,000	5,600	5,300
160	4,700	4,500	4,300	4,300	5,700	5,300	5,000	4,900	6,200	5,700	5,400	5,100
165	4,400	4,200	4,100	4,100	5,400	5,100	4,800	4,700	5,900	5,500	5,200	5,000
170	4,200	4,000	3,900	3,900	5,200	4,900	4,600	4,500	5,600	5,300	5,000	4,800
175	4,000	3,900	3,800	3,700	4,900	4,700	4,500	4,400	5,000	5,100	4,800	4,600
180	3,800	3,700	3,600	3,600	4,700	4,500	4,300	4,200	4,400	4,900	4,600	4,500
185	3,600	3,500	3,400	3,400	4,500	4,300	4,100	4,000	3,900	4,600	4,400	4,300
190	3,400	3,300	3,300	3,300	4,300	4,100	4,000	3,900	3,400	4,000	4,300	4,200
195	3,300	3,200	3,200	3,200	4,000	3,900	3,800	3,800	2,900	3,500	4,100	4,000
200	3,100	3,000	3,000		3,500	3,800	3,700	3,600	2,500	3,000	3,600	3,900
205	2,900	2,900	2,900		3,100	3,600	3,500	3,500		2,600	3,100	3,400
210	2,800	2,800	2,800		2,700	3,100	3,400	3,400		2,200	2,600	2,900
215	2,700	2,600	2,700		2,300	2,700	3,000	3,100			2,200	2,400
220	2,500	2,500				2,300	2,600	2,700				
225							2,200					
Min Angle	17.5	19.5	25.0	24.5	39.5	40.0	40.0	40.0	49.5	49.5	50.0	50.0
Max Rad. Capacity	225.0	225.0	220.0	213.0	220.0	225.0	227.5	227.5	205.0	212.5	217.5	219.0
	0	0	0	0	0	0	0	0	0	0	0	0

1051140



PORTLAND OFFICE: 503.283.3111
 SEATTLE OFFICE: 206.784.1054
WWW.NESSCAMPBELL.COM

Rated Lifting Capacities in Pounds

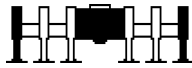

Full

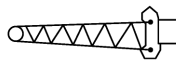

117ft Offset Fly



71,500 lbs



Radius (ft)	Boom Length (ft)			
	Fly Offset			
	185.5			
	2°	15°	30°	45°
60	9,000			
65	9,000			
70	9,000			
75	9,000			
80	9,000	9,000		
85	9,000	9,000		
90	9,000	9,000		
95	9,000	9,000	8,700	
100	9,000	9,000	8,400	
105	9,000	9,000	8,200	7,600
110	9,000	8,700	7,900	7,400
115	9,000	8,400	7,700	7,200
120	9,000	8,100	7,400	6,900
125	8,600	7,900	7,200	6,700
130	8,300	7,600	6,900	6,500
135	8,100	7,300	6,700	6,300
140	7,800	7,100	6,500	6,100
145	7,500	6,800	6,300	5,900
150	7,200	6,600	6,100	5,800
155	6,700	6,300	5,900	5,600
160	5,900	6,100	5,700	5,400
165	5,300	5,900	5,500	5,200
170	4,600	5,500	5,300	5,100
175	4,000	4,900	5,100	4,900
180	3,500	4,300	4,900	4,700
185	2,900	3,700	4,400	4,600
190	2,400	3,200	3,900	4,300
195		2,700	3,300	3,700
200		2,200	2,800	3,200
205			2,300	2,700
210				2,200
Min Angle	56.0	56.5	57.0	56.5
Max Rad.	195.0	202.0	208.0	212.0
Capacity	0	0	0	0

1051140



PORTLAND OFFICE: 503.283.3111
 SEATTLE OFFICE: 206.784.1054
WWW.NESSCAMPBELL.COM

Rated Lifting Capacities in Pounds

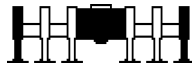

Full

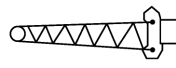

117ft Offset Fly



71,500 lbs



Radius (ft)	Boom Length (ft)											
	Fly Offset											
	44.3				73.5				103.8			
	2°	15°	30°	45°	2°	15°	30°	45°	2°	15°	30°	45°
25	15,800											
30	14,500				14,800							
35	13,300				14,800				13,100			
40	12,300	11,900			13,800				13,100			
45	11,400	11,000			12,900	12,000			13,100			
50	10,600	10,300	10,000		12,100	11,300			13,100			
55	9,900	9,600	9,400		11,300	10,700			12,600	11,500		
60	9,200	9,000	8,800		10,600	10,000	9,500		11,900	10,900		
65	8,600	8,400	8,300	8,200	10,000	9,500	9,000		11,300	10,400		
70	8,100	7,900	7,800	7,800	9,400	9,000	8,600	8,300	10,700	9,900	9,200	
75	7,600	7,500	7,400	7,300	8,900	8,500	8,200	7,900	10,100	9,400	8,800	
80	7,000	6,900	6,900	6,900	8,400	8,100	7,800	7,600	9,600	9,000	8,400	8,000
85	6,600	6,500	6,400	6,400	8,000	7,700	7,400	7,200	9,100	8,500	8,000	7,700
90	6,100	6,100	6,000	6,000	7,500	7,200	7,000	6,800	8,700	8,200	7,700	7,400
95	5,600	5,600	5,600	5,700	7,100	6,800	6,600	6,500	8,300	7,800	7,400	7,100
100	5,200	5,200	5,300	5,300	6,700	6,400	6,200	6,100	7,900	7,500	7,000	6,800
105	4,800	4,900	4,900	4,900	6,300	6,100	5,900	5,800	7,500	7,100	6,700	6,500
110	4,500	4,500	4,600	4,600	5,900	5,700	5,600	5,500	7,100	6,700	6,400	6,200
115	4,200	4,200	4,200	4,300	5,500	5,400	5,300	5,200	6,800	6,400	6,100	5,900
120	3,900	3,900	3,900	4,000	5,200	5,000	5,000	4,900	6,400	6,100	5,800	5,700
125	3,600	3,600	3,700	3,700	4,800	4,700	4,700	4,700	6,100	5,800	5,600	5,400
130	3,300	3,400	3,400	3,500	4,500	4,500	4,400	4,400	5,700	5,500	5,300	5,200
135	3,100	3,100	3,200		4,300	4,200	4,200	4,200	5,400	5,200	5,000	4,900
140	2,900	2,900	2,900		4,000	3,900	3,900	3,900	5,100	4,900	4,800	4,700
145	2,600	2,700			3,700	3,700	3,700	3,700	4,800	4,700	4,500	4,500
150	2,500	2,500			3,500	3,500	3,500	3,500	4,600	4,400	4,300	4,300
155					3,300	3,300	3,300	3,300	4,300	4,200	4,100	4,100
160					3,100	3,100	3,100		4,100	4,000	3,900	3,900
165					2,900	2,900	2,900		3,900	3,800	3,700	3,700
170					2,700	2,700	2,700		3,700	3,600	3,500	3,600
175					2,600	2,600			3,500	3,400	3,400	3,400
180									3,300	3,200	3,200	3,200
185									3,100	3,100	3,100	
190									3,000	2,900	2,900	
195									2,800	2,800	2,800	
200									2,700	2,600	2,700	
205									2,500	2,500		
Min Angle	0.0	0.0	0.0	0.0	13.5	16.0	24.0	29.5	15.0	17.0	23.5	27.5
Max Rad. Capacity	152.9	152.4	149.4	144.0	180.0	180.0	175.0	166.2	210.0	210.0	205.0	196.4
	2,400	2,400	2,500	2,700	0	0	0	0	0	0	0	0

1051150



PORTLAND OFFICE: 503.283.3111
 SEATTLE OFFICE: 206.784.1054
WWW.NESSCAMPBELL.COM

Rated Lifting Capacities in Pounds

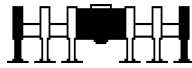

Full

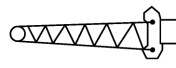

117ft Offset Fly



71,500 lbs



Radius (ft)	Boom Length (ft)											
	Fly Offset											
	119.4				135.4				152.0			
	2°	15°	30°	45°	2°	15°	30°	45°	2°	15°	30°	45°
40	12,800											
45	12,800				12,700							
50	12,800				12,700				11,900			
55	12,800				12,700				11,900			
60	12,500	11,300			12,700	11,700			11,900			
65	11,800	10,800			12,400	11,100			11,900	11,500		
70	11,200	10,300			11,800	10,700			11,900	11,000		
75	10,700	9,800	9,100		11,200	10,200	9,300		11,800	10,500		
80	10,200	9,400	8,700		10,700	9,800	8,900		11,200	10,100	9,200	
85	9,700	9,000	8,300	7,900	10,200	9,300	8,600	8,100	10,800	9,700	8,900	
90	9,300	8,600	8,000	7,600	9,800	9,000	8,300	7,800	10,300	9,300	8,500	8,000
95	8,800	8,200	7,700	7,300	9,400	8,600	8,000	7,500	9,900	9,000	8,200	7,700
100	8,400	7,900	7,400	7,000	9,000	8,300	7,700	7,300	9,500	8,600	8,000	7,500
105	8,100	7,600	7,100	6,800	8,600	7,900	7,400	7,000	9,100	8,300	7,700	7,300
110	7,700	7,200	6,800	6,500	8,200	7,600	7,100	6,700	8,700	8,000	7,400	7,000
115	7,400	6,900	6,500	6,200	7,900	7,300	6,800	6,500	8,400	7,700	7,100	6,700
120	7,000	6,600	6,200	6,000	7,600	7,000	6,500	6,200	8,100	7,400	6,900	6,500
125	6,700	6,300	5,900	5,700	7,200	6,700	6,300	6,000	7,800	7,100	6,600	6,300
130	6,300	6,000	5,700	5,500	6,900	6,400	6,000	5,800	7,400	6,800	6,400	6,100
135	6,000	5,700	5,400	5,300	6,600	6,100	5,800	5,600	7,100	6,600	6,100	5,800
140	5,700	5,400	5,200	5,000	6,300	5,900	5,600	5,400	6,800	6,300	5,900	5,600
145	5,400	5,100	4,900	4,800	6,000	5,600	5,300	5,100	6,500	6,000	5,700	5,400
150	5,100	4,900	4,700	4,600	5,700	5,400	5,100	4,900	6,200	5,800	5,400	5,200
155	4,900	4,700	4,500	4,400	5,400	5,100	4,900	4,700	6,000	5,500	5,200	5,000
160	4,600	4,400	4,300	4,200	5,100	4,900	4,700	4,600	5,700	5,300	5,000	4,900
165	4,400	4,200	4,100	4,100	4,900	4,700	4,500	4,400	5,400	5,100	4,800	4,700
170	4,200	4,000	3,900	3,900	4,700	4,400	4,300	4,200	5,200	4,900	4,600	4,500
175	4,000	3,800	3,700	3,700	4,400	4,200	4,100	4,000	4,900	4,700	4,400	4,300
180	3,800	3,700	3,600	3,600	4,200	4,100	3,900	3,900	4,700	4,500	4,300	4,200
185	3,600	3,500	3,400	3,400	4,000	3,900	3,800	3,700	4,500	4,300	4,100	4,000
190	3,400	3,300	3,300	3,300	3,800	3,700	3,600	3,600	4,300	4,100	3,900	3,900
195	3,200	3,200	3,100	3,200	3,700	3,500	3,500	3,500	4,000	3,900	3,800	3,800
200	3,100	3,000	3,000		3,500	3,400	3,300	3,300	3,600	3,800	3,700	3,600
205	2,900	2,900	2,900		3,300	3,200	3,200	3,200	3,100	3,600	3,500	3,500
210	2,800	2,700	2,700		3,200	3,100	3,100		2,700	3,200	3,400	3,400
215	2,600	2,600	2,600		3,000	3,000	2,900		2,400	2,800	3,100	3,200
220	2,500	2,500			2,900	2,800	2,800			2,400	2,700	2,700
225					2,800	2,700	2,700				2,200	
230					2,600	2,600	2,600					
235					2,300	2,400						
Min Angle	16.5	18.5	24.0	26.0	17.5	19.5	24.5	24.0	39.0	39.5	39.5	39.0
Max Rad.	225.0	225.0	220.0	212.0	240.0	240.0	235.0	228.1	220.0	225.0	228.3	228.0
Capacity	0	0	0	0	0	0	0	0	0	0	0	0

1051150



PORTLAND OFFICE: 503.283.3111
 SEATTLE OFFICE: 206.784.1054
WWW.NESSCAMPBELL.COM

Rated Lifting Capacities in Pounds

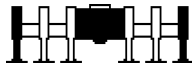

Full

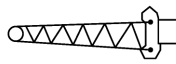

117ft Offset Fly

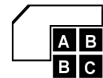

71,500 lbs



Radius (ft)	Boom Length (ft)			
	Fly Offset			
	168.5			
	2°	15°	30°	45°
50	10,200			
55	10,200			
60	10,200			
65	10,200			
70	10,200	10,100		
75	10,200	10,100		
80	10,200	10,100		
85	10,200	10,100	9,100	
90	10,200	9,700	8,800	
95	10,200	9,300	8,500	7,900
100	9,900	9,000	8,200	7,700
105	9,500	8,700	7,900	7,400
110	9,200	8,300	7,700	7,200
115	8,800	8,100	7,400	7,000
120	8,500	7,800	7,200	6,700
125	8,200	7,500	6,900	6,500
130	7,900	7,200	6,700	6,300
135	7,600	7,000	6,400	6,100
140	7,300	6,700	6,200	5,900
145	7,000	6,400	6,000	5,700
150	6,700	6,200	5,800	5,500
155	6,500	6,000	5,600	5,300
160	6,200	5,700	5,400	5,100
165	5,900	5,500	5,200	5,000
170	5,600	5,300	5,000	4,800
175	5,000	5,100	4,800	4,600
180	4,400	4,900	4,600	4,500
185	3,900	4,600	4,400	4,300
190	3,400	4,100	4,300	4,200
195	3,000	3,600	4,100	4,000
200	2,500	3,100	3,600	3,900
205	2,100	2,600	3,100	3,400
210		2,200	2,700	2,900
215			2,200	2,400
Min Angle	48.5	49.0	49.5	50.0
Max Rad. Capacity	206.3	212.5	217.5	219.0
	0	0	0	0

1051150



PORTLAND OFFICE: 503.283.3111
 SEATTLE OFFICE: 206.784.1054
WWW.NESSCAMPBELL.COM

Rated Lifting Capacities in Pounds

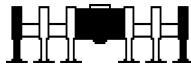

Full

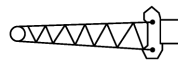

117ft Hydraulic Offset Fly



71,500 lbs



Radius (ft)	Boom Length (ft)											
	Fly Offset											
	44.3			73.5			103.8			134.9		
	2°-15°	15°-30°	30°-45°	2°-15°	15°-30°	30°-45°	2°-15°	15°-30°	30°-45°	2°-15°	15°-30°	30°-45°
25	15,800											
30	14,500			14,800								
35	12,800	12,800		14,800			13,100					
40	11,900	11,900		12,900	12,900		13,100					
45	11,000	11,000		12,000	12,000		13,100			11,000		
50	10,300	10,000	10,000	11,300	11,300		12,200	12,200		11,000		
55	9,600	9,400	9,400	10,700	10,100	10,100	11,500	11,500		11,000		
60	9,000	8,800	8,700	10,000	9,500	9,500	10,900	10,900		10,900	10,900	
65	8,400	8,300	8,200	9,500	9,000	8,700	10,400	9,600	9,600	10,900	10,900	
70	7,900	7,800	7,800	9,000	8,600	8,300	9,900	9,200	9,200	10,600	10,600	
75	7,500	7,400	7,300	8,500	8,200	7,900	9,400	8,800	8,400	10,200	9,300	9,300
80	6,900	6,900	6,900	8,100	7,800	7,600	9,000	8,400	8,000	9,700	8,900	8,900
85	6,500	6,400	6,400	7,700	7,400	7,200	8,500	8,000	7,700	9,300	8,600	8,100
90	6,100	6,000	6,000	7,200	7,000	6,800	8,200	7,700	7,400	8,900	8,300	7,800
95	5,600	5,600	5,600	6,800	6,600	6,500	7,800	7,400	7,100	8,600	8,000	7,500
100	5,200	5,200	5,300	6,400	6,200	6,100	7,500	7,000	6,800	8,200	7,700	7,300
105	4,800	4,900	4,900	6,100	5,900	5,800	7,100	6,700	6,500	7,900	7,400	7,000
110	4,500	4,500	4,600	5,700	5,600	5,500	6,700	6,400	6,200	7,600	7,100	6,700
115	4,200	4,200	4,200	5,400	5,300	5,200	6,400	6,100	5,900	7,300	6,800	6,500
120	3,900	3,900	3,900	5,000	5,000	4,900	6,100	5,800	5,700	7,000	6,500	6,200
125	3,600	3,600	3,700	4,700	4,700	4,700	5,800	5,600	5,400	6,700	6,300	6,000
130	3,300	3,400	3,400	4,500	4,400	4,400	5,500	5,300	5,200	6,400	6,000	5,800
135	3,100	3,100	3,200	4,200	4,200	4,200	5,200	5,000	4,900	6,100	5,800	5,600
140	2,900	2,900	2,900	3,900	3,900	3,900	4,900	4,800	4,700	5,900	5,500	5,400
145	2,600	2,700		3,700	3,700	3,700	4,700	4,500	4,500	5,600	5,300	5,100
150	2,500	2,500		3,500	3,500	3,500	4,400	4,300	4,300	5,300	5,100	4,900
155				3,300	3,300	3,300	4,200	4,100	4,100	5,100	4,900	4,700
160				3,100	3,100	3,100	4,000	3,900	3,900	4,900	4,700	4,500
165				2,900	2,900	2,900	3,800	3,700	3,700	4,600	4,500	4,400
170				2,700	2,700		3,600	3,500	3,500	4,400	4,300	4,200
175				2,600			3,400	3,400	3,400	4,200	4,100	4,000
180							3,200	3,200	3,200	4,000	3,900	3,900
185							3,100	3,100	3,100	3,900	3,800	3,700
190							2,900	2,900	2,900	3,700	3,600	3,600
195							2,800	2,800	2,800	3,500	3,500	3,500
200							2,600	2,600		3,400	3,300	3,300
205							2,500			3,200	3,200	3,200
210										3,100	3,100	3,100
215										3,000	2,900	2,900
220										2,800	2,800	2,800
225										2,700	2,700	2,700
230										2,500	2,600	
235										2,400		
Min Angle	0.0	0.0	0.0	13.5	24.0	29.5	15.0	23.5	27.5	18.0	25.0	26.0
Max Rad. Capacity	152.9	152.4	149.4	180.0	175.0	166.2	210.0	205.0	196.4	240.0	235.0	227.6
	2,400	2,400	2,500	0	0	0	0	0	0	0	0	0

1052130



PORTLAND OFFICE: 503.283.3111
 SEATTLE OFFICE: 206.784.1054
WWW.NESSCAMPBELL.COM

Rated Lifting Capacities in Pounds

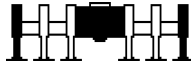

Full

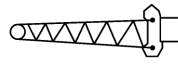

117ft Hydraulic Offset Fly



71,500 lbs



Radius (ft)	Boom Length (ft)								
	Fly Offset								
	167.1			183.6			200.1		
	2°-15°	15°-30°	30°-45°	2°-15°	15°-30°	30°-45°	2°-15°	15°-30°	30°-45°
50	8,600								
55	8,600								
60	8,600			7,900			6,700		
65	8,500	8,500		7,900			6,700		
70	8,500	8,500		7,800	7,800		6,600	6,600	
75	8,500	8,500		7,800	7,800		6,600	6,600	
80	8,500	8,500		7,800	7,800		6,600	6,600	
85	8,500	8,400	8,400	7,800	7,600	7,600	6,600	6,600	
90	8,500	8,400	8,400	7,800	7,600	7,600	6,600	6,600	
95	8,500	8,400	7,900	7,800	7,600	7,600	6,600	6,400	6,400
100	8,500	8,200	7,600	7,800	7,600	7,400	6,600	6,400	6,400
105	8,500	7,900	7,400	7,800	7,600	7,400	6,600	6,400	6,200
110	8,300	7,600	7,200	7,800	7,600	7,400	6,600	6,400	6,200
115	8,000	7,400	6,900	7,800	7,600	7,200	6,600	6,400	6,200
120	7,800	7,100	6,700	7,800	7,400	6,900	6,600	6,400	6,200
125	7,500	6,900	6,500	7,800	7,200	6,700	6,600	6,400	6,200
130	7,200	6,600	6,300	7,600	6,900	6,500	6,600	6,400	6,200
135	6,900	6,400	6,100	7,300	6,700	6,300	6,600	6,400	6,200
140	6,700	6,200	5,900	7,000	6,500	6,100	6,600	6,400	6,200
145	6,400	6,000	5,700	6,800	6,200	5,900	6,600	6,400	6,100
150	6,200	5,700	5,500	6,500	6,000	5,700	6,600	6,300	5,900
155	5,900	5,500	5,300	6,300	5,800	5,600	6,600	6,100	5,800
160	5,700	5,300	5,100	6,100	5,600	5,400	6,100	5,900	5,600
165	5,500	5,100	4,900	5,900	5,400	5,200	5,400	5,700	5,400
170	5,200	4,900	4,800	5,600	5,200	5,000	4,700	5,500	5,300
175	5,000	4,700	4,600	5,000	5,100	4,900	4,100	5,000	5,100
180	4,800	4,600	4,400	4,500	4,900	4,700	3,600	4,400	4,900
185	4,600	4,400	4,300	4,000	4,700	4,600	3,100	3,800	4,600
190	4,400	4,200	4,100	3,500	4,100	4,400	2,600	3,300	4,000
195	4,000	4,100	4,000	3,000	3,600	4,200	2,100	2,800	3,500
200	3,500	3,900	3,900	2,500	3,200	3,700		2,300	3,000
205	3,100	3,600	3,700	2,100	2,700	3,200			2,500
210	2,700	3,200	3,600		2,300	2,800			
215	2,400	2,800	3,200			2,300			
220		2,400	2,700						
225			2,300						
Min Angle	45.5	46.0	46.0	53.0	53.5	54.0	58.5	59.5	60.0
Max Rad. Capacity	220.0	225.0	230.0	206.3	213.8	218.8	196.3	203.8	210.0
	0	0	0	0	0	0	0	0	0

1052130



PORTLAND OFFICE: 503.283.3111
 SEATTLE OFFICE: 206.784.1054
WWW.NESSCAMPBELL.COM

Rated Lifting Capacities in Pounds

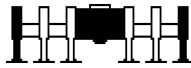

Full

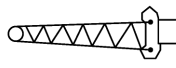

117ft Hydraulic Offset Fly



71,500 lbs



Radius (ft)	Boom Length (ft)											
	Fly Offset											
	44.3			58.9			89.1			120.3		
	2°-15°	15°-30°	30°-45°	2°-15°	15°-30°	30°-45°	2°-15°	15°-30°	30°-45°	2°-15°	15°-30°	30°-45°
25	15,800			16,400								
30	14,500			15,300								
35	12,800	12,800		13,300	13,300		15,600					
40	11,900	11,900		12,400	12,400		14,500			14,400		
45	11,000	11,000		11,600	11,600		12,500	12,500		14,400		
50	10,300	10,000	10,000	10,800	10,400	10,400	11,800	11,800		14,000		
55	9,600	9,400	9,400	10,200	9,800	9,800	11,100	11,100		11,900	11,900	
60	9,000	8,800	8,700	9,600	9,200	9,200	10,500	9,800	9,800	11,300	11,300	
65	8,400	8,300	8,200	9,000	8,700	8,500	10,000	9,400	9,400	10,800	9,900	9,900
70	7,900	7,800	7,800	8,500	8,200	8,100	9,500	8,900	8,500	10,300	9,500	9,500
75	7,500	7,400	7,300	8,000	7,800	7,700	9,000	8,500	8,200	9,800	9,100	9,100
80	6,900	6,900	6,900	7,600	7,400	7,300	8,500	8,100	7,800	9,400	8,700	8,200
85	6,500	6,400	6,400	7,100	6,900	6,900	8,100	7,700	7,500	9,000	8,300	7,900
90	6,100	6,000	6,000	6,700	6,500	6,500	7,800	7,400	7,200	8,600	8,000	7,600
95	5,600	5,600	5,600	6,300	6,200	6,100	7,400	7,000	6,800	8,200	7,700	7,400
100	5,200	5,200	5,300	5,900	5,800	5,800	7,000	6,700	6,500	7,900	7,400	7,100
105	4,800	4,900	4,900	5,500	5,400	5,400	6,600	6,300	6,200	7,600	7,100	6,800
110	4,500	4,500	4,600	5,100	5,100	5,100	6,300	6,000	5,900	7,200	6,800	6,500
115	4,200	4,200	4,200	4,800	4,800	4,800	6,000	5,700	5,600	6,900	6,500	6,200
120	3,900	3,900	3,900	4,500	4,500	4,500	5,600	5,400	5,300	6,600	6,200	6,000
125	3,600	3,600	3,700	4,200	4,200	4,200	5,300	5,200	5,100	6,300	6,000	5,800
130	3,300	3,400	3,400	3,900	3,900	3,900	5,000	4,900	4,800	6,000	5,700	5,500
135	3,100	3,100	3,200	3,700	3,700	3,700	4,700	4,600	4,600	5,700	5,400	5,300
140	2,900	2,900	2,900	3,400	3,400	3,500	4,500	4,400	4,400	5,400	5,200	5,100
145	2,600	2,700		3,200	3,200	3,200	4,200	4,200	4,100	5,200	5,000	4,800
150	2,500	2,500		3,000	3,000	3,000	4,000	3,900	3,900	4,900	4,700	4,600
155				2,800	2,800		3,800	3,700	3,700	4,700	4,500	4,400
160				2,600			3,600	3,500	3,500	4,500	4,300	4,300
165							3,400	3,400	3,400	4,200	4,100	4,100
170							3,200	3,200	3,200	4,000	3,900	3,900
175							3,000	3,000	3,000	3,900	3,800	3,700
180							2,900	2,900	2,900	3,700	3,600	3,600
185							2,700	2,700		3,500	3,400	3,400
190							2,600			3,300	3,300	3,300
195										3,200	3,200	3,200
200										3,000	3,000	3,000
205										2,900	2,900	2,900
210										2,800	2,800	2,800
215										2,600	2,600	
220										2,500		
Min Angle	0.0	0.0	0.0	14.0	25.5	30.0	14.5	24.0	27.0	17.5	25.0	24.5
Max Rad.	152.9	152.4	149.4	165.0	160.0	151.6	195.0	190.0	181.8	225.0	220.0	213.0
Capacity	2,400	2,400	2,500	0	0	0	0	0	0	0	0	0

1052140



PORTLAND OFFICE: 503.283.3111
 SEATTLE OFFICE: 206.784.1054
WWW.NESSCAMPBELL.COM

Rated Lifting Capacities in Pounds

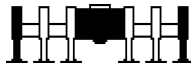

Full

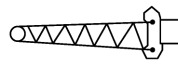

117ft Hydraulic Offset Fly



71,500 lbs



Radius (ft)	Boom Length (ft)								
	Fly Offset								
	152.4			169.0			185.5		
	2°-15°	15°-30°	30°-45°	2°-15°	15°-30°	30°-45°	2°-15°	15°-30°	30°-45°
50	11,500								
55	11,500			10,600					
60	11,500			10,600			9,000		
65	11,400	11,400		10,400	10,400		9,000		
70	11,000	11,000		10,400	10,400		8,900	8,900	
75	10,600	10,600		10,400	10,400		8,900	8,900	
80	10,100	9,200	9,200	10,400	10,400		8,900	8,900	
85	9,700	8,900	8,900	10,100	9,100	9,100	8,900	8,900	
90	9,300	8,500	8,000	9,700	8,800	8,800	8,900	8,700	8,700
95	9,000	8,200	7,700	9,300	8,500	7,900	8,900	8,700	8,700
100	8,600	8,000	7,500	9,000	8,200	7,700	8,900	8,400	7,800
105	8,300	7,700	7,300	8,700	7,900	7,400	8,900	8,200	7,600
110	8,000	7,400	7,000	8,400	7,700	7,200	8,700	7,900	7,400
115	7,700	7,100	6,700	8,100	7,400	7,000	8,400	7,700	7,200
120	7,400	6,900	6,500	7,800	7,200	6,700	8,100	7,400	6,900
125	7,100	6,600	6,300	7,500	6,900	6,500	7,900	7,200	6,700
130	6,800	6,400	6,100	7,200	6,700	6,300	7,600	6,900	6,500
135	6,600	6,100	5,900	7,000	6,400	6,100	7,300	6,700	6,300
140	6,300	5,900	5,700	6,700	6,200	5,900	7,100	6,500	6,100
145	6,100	5,700	5,500	6,400	6,000	5,700	6,800	6,300	5,900
150	5,800	5,500	5,300	6,200	5,800	5,500	6,600	6,100	5,800
155	5,600	5,200	5,100	6,000	5,600	5,300	6,300	5,900	5,600
160	5,300	5,000	4,900	5,700	5,400	5,100	5,900	5,700	5,400
165	5,100	4,800	4,700	5,500	5,200	5,000	5,300	5,500	5,200
170	4,900	4,600	4,500	5,300	5,000	4,800	4,600	5,300	5,100
175	4,700	4,500	4,400	5,000	4,800	4,600	4,000	4,900	4,900
180	4,500	4,300	4,200	4,400	4,600	4,500	3,500	4,300	4,700
185	4,300	4,100	4,000	3,900	4,400	4,300	2,900	3,700	4,400
190	4,100	4,000	3,900	3,400	4,000	4,200	2,400	3,200	3,900
195	3,900	3,800	3,800	2,900	3,500	4,000		2,700	3,300
200	3,500	3,700	3,600	2,500	3,000	3,600		2,200	2,800
205	3,100	3,500	3,500		2,600	3,100			2,300
210	2,700	3,100	3,400		2,200	2,600			
215	2,300	2,700	3,000			2,200			
220		2,300	2,600						
225			2,200						
Min Angle	39.5	40.0	40.0	49.5	49.5	50.0	56.0	56.5	57.0
Max Rad. Capacity	220.0	225.0	227.5	205.0	212.5	217.5	195.0	202.0	208.0
	0	0	0	0	0	0	0	0	0

1052140



PORTLAND OFFICE: 503.283.3111
 SEATTLE OFFICE: 206.784.1054
WWW.NESSCAMPBELL.COM

Rated Lifting Capacities in Pounds

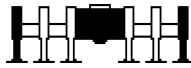

Full

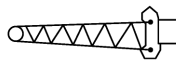

117ft Hydraulic Offset Fly



71,500 lbs



Radius (ft)	Boom Length (ft)											
	Fly Offset											
	44.3			73.5			103.8			119.4		
	2°-15°	15°-30°	30°-45°	2°-15°	15°-30°	30°-45°	2°-15°	15°-30°	30°-45°	2°-15°	15°-30°	30°-45°
25	15,800											
30	14,500			14,800								
35	12,800	12,800		14,800			13,100					
40	11,900	11,900		12,900	12,900		13,100			12,800		
45	11,000	11,000		12,000	12,000		13,100			12,800		
50	10,300	10,000	10,000	11,300	11,300		12,200	12,200		12,800		
55	9,600	9,400	9,400	10,700	10,100	10,100	11,500	11,500		11,900	11,900	
60	9,000	8,800	8,700	10,000	9,500	9,500	10,900	10,900		11,300	11,300	
65	8,400	8,300	8,200	9,500	9,000	8,700	10,400	9,600	9,600	10,800	10,800	
70	7,900	7,800	7,800	9,000	8,600	8,300	9,900	9,200	9,200	10,300	9,500	9,500
75	7,500	7,400	7,300	8,500	8,200	7,900	9,400	8,800	8,400	9,800	9,100	9,100
80	6,900	6,900	6,900	8,100	7,800	7,600	9,000	8,400	8,000	9,400	8,700	8,200
85	6,500	6,400	6,400	7,700	7,400	7,200	8,500	8,000	7,700	9,000	8,300	7,900
90	6,100	6,000	6,000	7,200	7,000	6,800	8,200	7,700	7,400	8,600	8,000	7,600
95	5,600	5,600	5,600	6,800	6,600	6,500	7,800	7,400	7,100	8,200	7,700	7,300
100	5,200	5,200	5,300	6,400	6,200	6,100	7,500	7,000	6,800	7,900	7,400	7,000
105	4,800	4,900	4,900	6,100	5,900	5,800	7,100	6,700	6,500	7,600	7,100	6,800
110	4,500	4,500	4,600	5,700	5,600	5,500	6,700	6,400	6,200	7,200	6,800	6,500
115	4,200	4,200	4,200	5,400	5,300	5,200	6,400	6,100	5,900	6,900	6,500	6,200
120	3,900	3,900	3,900	5,000	5,000	4,900	6,100	5,800	5,700	6,600	6,200	6,000
125	3,600	3,600	3,700	4,700	4,700	4,700	5,800	5,600	5,400	6,300	5,900	5,700
130	3,300	3,400	3,400	4,500	4,400	4,400	5,500	5,300	5,200	6,000	5,700	5,500
135	3,100	3,100	3,200	4,200	4,200	4,200	5,200	5,000	4,900	5,700	5,400	5,300
140	2,900	2,900	2,900	3,900	3,900	3,900	4,900	4,800	4,700	5,400	5,200	5,000
145	2,600	2,700		3,700	3,700	3,700	4,700	4,500	4,500	5,100	4,900	4,800
150	2,500	2,500		3,500	3,500	3,500	4,400	4,300	4,300	4,900	4,700	4,600
155				3,300	3,300	3,300	4,200	4,100	4,100	4,700	4,500	4,400
160				3,100	3,100	3,100	4,000	3,900	3,900	4,400	4,300	4,200
165				2,900	2,900	2,900	3,800	3,700	3,700	4,200	4,100	4,100
170				2,700	2,700		3,600	3,500	3,500	4,000	3,900	3,900
175				2,600			3,400	3,400	3,400	3,800	3,700	3,700
180							3,200	3,200	3,200	3,700	3,600	3,600
185							3,100	3,100	3,100	3,500	3,400	3,400
190							2,900	2,900	2,900	3,300	3,300	3,300
195							2,800	2,800	2,800	3,200	3,100	3,100
200							2,600	2,600		3,000	3,000	3,000
205							2,500			2,900	2,900	2,900
210										2,700	2,700	2,700
215										2,600	2,600	
220										2,500		
Min Angle	0.0	0.0	0.0	13.5	24.0	29.5	15.0	23.5	27.5	16.5	24.0	26.0
Max Rad.	152.9	152.4	149.4	180.0	175.0	166.2	210.0	205.0	196.4	225.0	220.0	212.0
Capacity	2,400	2,400	2,500	0	0	0	0	0	0	0	0	0

1052150



PORTLAND OFFICE: 503.283.3111
 SEATTLE OFFICE: 206.784.1054
WWW.NESSCAMPBELL.COM

Rated Lifting Capacities in Pounds

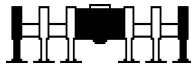

Full

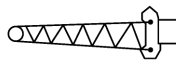

117ft Hydraulic Offset Fly



71,500 lbs



Radius (ft)	Boom Length (ft)								
	Fly Offset								
	135.4			152.0			168.5		
	2°-15°	15°-30°	30°-45°	2°-15°	15°-30°	30°-45°	2°-15°	15°-30°	30°-45°
45	12,700								
50	12,700			11,900			10,200		
55	12,700			11,900			10,200		
60	11,700	11,700		11,700	11,700		10,200		
65	11,100	11,100		11,500	11,500		10,000	10,000	
70	10,700	9,700	9,700	11,000	11,000		10,000	10,000	
75	10,200	9,300	9,300	10,500	9,500	9,500	10,000	10,000	
80	9,800	8,900	8,900	10,100	9,200	9,200	10,000	10,000	
85	9,300	8,600	8,100	9,700	8,900	8,300	10,000	9,100	9,100
90	9,000	8,300	7,800	9,300	8,500	8,000	9,700	8,800	8,800
95	8,600	8,000	7,500	9,000	8,200	7,700	9,300	8,500	7,900
100	8,300	7,700	7,300	8,600	8,000	7,500	9,000	8,200	7,700
105	7,900	7,400	7,000	8,300	7,700	7,300	8,700	7,900	7,400
110	7,600	7,100	6,700	8,000	7,400	7,000	8,300	7,700	7,200
115	7,300	6,800	6,500	7,700	7,100	6,700	8,100	7,400	7,000
120	7,000	6,500	6,200	7,400	6,900	6,500	7,800	7,200	6,700
125	6,700	6,300	6,000	7,100	6,600	6,300	7,500	6,900	6,500
130	6,400	6,000	5,800	6,800	6,400	6,100	7,200	6,700	6,300
135	6,100	5,800	5,600	6,600	6,100	5,800	7,000	6,400	6,100
140	5,900	5,600	5,400	6,300	5,900	5,600	6,700	6,200	5,900
145	5,600	5,300	5,100	6,000	5,700	5,400	6,400	6,000	5,700
150	5,400	5,100	4,900	5,800	5,400	5,200	6,200	5,800	5,500
155	5,100	4,900	4,700	5,500	5,200	5,000	6,000	5,600	5,300
160	4,900	4,700	4,600	5,300	5,000	4,900	5,700	5,400	5,100
165	4,700	4,500	4,400	5,100	4,800	4,700	5,500	5,200	5,000
170	4,400	4,300	4,200	4,900	4,600	4,500	5,300	5,000	4,800
175	4,200	4,100	4,000	4,700	4,400	4,300	5,000	4,800	4,600
180	4,100	3,900	3,900	4,500	4,300	4,200	4,400	4,600	4,500
185	3,900	3,800	3,700	4,300	4,100	4,000	3,900	4,400	4,300
190	3,700	3,600	3,600	4,100	3,900	3,900	3,400	4,100	4,200
195	3,500	3,500	3,500	3,900	3,800	3,800	3,000	3,600	4,000
200	3,400	3,300	3,300	3,600	3,700	3,600	2,500	3,100	3,600
205	3,200	3,200	3,200	3,100	3,500	3,500	2,100	2,600	3,100
210	3,100	3,100	3,100	2,700	3,200	3,400		2,200	2,700
215	3,000	2,900	2,900	2,400	2,800	3,100			2,200
220	2,800	2,800	2,800		2,400	2,700			
225	2,700	2,700	2,700			2,200			
230	2,600	2,600							
235	2,300								
Min Angle	17.5	24.5	24.0	39.0	39.5	39.0	48.5	49.0	49.5
Max Rad. Capacity	240.0	235.0	228.1	220.0	225.0	228.0	206.3	212.5	217.5
	0	0	0	0	0	0	0	0	0

1052150



PORTLAND OFFICE: 503.283.3111
 SEATTLE OFFICE: 206.784.1054
WWW.NESSCAMPBELL.COM

Rated Lifting Capacities in Pounds

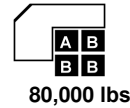
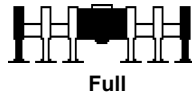

Boom Length (ft)											
Extend Mode											
Radius (ft)	44.3	58.9	59.4	59.9	73.5	74.0	75.0	75.9	88.7	89.1	89.6
	ALL	EM2, EM5	EM6	EM7	EM1, EM3, EM4	EM5	EM6	EM7	EM4	EM2	EM5
10	291,800	195,200	292,600	291,800	134,800	196,100	247,000	262,200	125,300	120,100	168,700
12	263,100	182,900	264,700	263,800	125,600	182,200	228,300	256,800	117,000	112,200	168,700
15	227,800	167,200	230,100	229,200	114,000	164,700	205,000	228,400	106,200	102,000	161,600
20	184,200	146,500	187,100	186,100	98,600	141,800	175,200	186,000	91,900	88,500	140,000
25	147,200	130,500	151,400	150,200	86,700	124,400	152,600	150,400	80,800	78,000	123,300
30	120,000	117,900	124,200	123,000	75,900	110,800	125,500	123,300	72,100	69,600	110,000
35	100,100	105,400	104,500	103,300	67,200	99,800	105,800	103,800	65,000	62,800	99,200
40		90,400	89,400	88,200	60,000	90,700	90,800	88,700	59,100	57,100	90,200
45		78,600	77,700	76,500	54,100	80,800	79,100	77,000	54,100	51,700	81,400
50		58,500	66,400	65,000	49,300	70,100	68,200	65,700	49,900	47,100	70,500
55					45,200	60,100	58,200	55,800	46,200	43,300	60,700
60					41,900	52,300	50,400	48,100	43,100	39,900	52,900
65						45,300	44,100	41,800	40,300	37,000	46,600
70									37,900	34,400	41,300
75									35,800	32,200	36,900
80									25,000	30,300	33,200
Unpinned		101,200	89,600	80,400	55,600	95,600	89,600	72,800	98,200	56,000	83,900
Min Angle	0.0	0.0	0.0	0.0	0.0	0.0	0.0	0.0	0.0	0.0	0.0
Max Rad. Capacity	35.7	50.4	50.8	51.3	65.0	65.5	66.4	67.4	80.1	80.6	81.1
Capacity	66,600	22,600	48,400	47,000	12,200	19,400	36,200	33,900	10,700	16,400	16,100

1060010



PORTLAND OFFICE: 503.283.3111
 SEATTLE OFFICE: 206.784.1054
WWW.NESSCAMPBELL.COM

Rated Lifting Capacities in Pounds

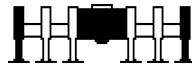

Full



80,000 lbs



360°

Radius (ft)	Boom Length (ft)											
	Extend Mode											
	91.0	92.5	103.8	104.2	105.7	107.6	119.4	120.3	120.3	122.2	124.1	134.9
	EM6	EM7	EM1, EM3	EM4	EM5	EM6	EM3	EM4	EM2	EM5	EM6	EM1
10	212,200	203,700										
12	212,200	203,700										
15	198,500	203,700	84,300	100,600	128,900							
20	169,700	184,500	76,600	97,200	128,900	172,300	66,300	92,800	77,300	120,900	129,700	54,700
25	148,100	149,000	67,600	86,600	124,700	150,400	66,300	91,000	69,400	120,900	112,800	54,700
30	125,100	122,100	60,300	78,100	111,500	123,600	64,000	82,700	62,100	118,300	99,400	54,700
35	105,500	102,700	54,400	71,000	100,600	104,200	58,200	75,900	56,200	105,800	88,400	52,400
40	90,700	87,600	49,500	65,000	91,600	89,400	53,300	70,000	51,200	91,000	79,400	47,800
45	79,000	76,000	45,300	60,000	80,900	77,700	48,900	64,900	46,900	79,500	71,900	43,800
50	67,800	64,300	41,700	55,700	69,700	66,200	45,100	60,500	43,200	68,100	65,000	40,400
55	58,000	54,600	38,700	51,900	59,900	56,400	41,800	56,700	40,000	58,300	55,200	37,400
60	50,400	47,100	36,000	48,600	52,100	48,900	38,900	53,300	37,200	50,700	47,800	34,800
65	44,000	40,800	33,400	45,700	46,000	42,600	36,400	47,400	34,700	44,400	41,600	32,400
70	38,800	35,600	31,000	43,000	40,800	37,500	34,100	42,200	32,500	39,300	36,400	30,400
75	34,400	31,400	28,900	38,500	36,400	33,300	32,100	37,800	30,500	34,900	32,300	28,500
80	30,700	27,700	27,100	34,700	32,700	29,600	30,300	34,200	28,700	31,400	28,700	26,800
85			25,400	31,600	29,500	26,400	28,600	30,900	27,100	28,200	25,500	25,300
90			24,000	28,700	26,600	23,600	27,100	28,100	25,600	25,400	22,700	23,900
95			21,700	25,500	24,200	21,100	25,700	25,600	24,300	22,900	20,300	22,600
100							24,500	23,400	23,100	20,700	18,100	21,400
105							22,700	21,400	21,700	18,800	16,300	20,300
110							21,000	19,700	20,000	17,100	14,600	19,300
115											13,000	18,400
120												17,600
125												16,700
Unpinned	74,300	60,200	60,700	86,100	75,900	61,400	66,300	77,900	60,700	61,800	44,600	54,700
Min Angle	0.0	0.0	0.0	0.0	0.0	0.0	0.0	0.0	0.0	0.0	0.0	0.0
Max Rad.	82.5	83.9	95.2	95.7	97.1	99.0	110.8	111.7	111.8	113.7	115.6	126.4
Capacity	26,900	23,600	9,400	9,100	12,800	19,000	7,900	7,300	11,300	9,500	12,900	6,700

1060010



PORTLAND OFFICE: 503.283.3111
 SEATTLE OFFICE: 206.784.1054
WWW.NESSCAMPBELL.COM

Rated Lifting Capacities in Pounds

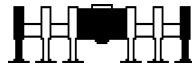

Full



80,000 lbs



Boom Length (ft)											
Extend Mode											
Radius (ft)	135.4	136.8	152.0	152.4	153.4	167.1	168.5	169.0	183.6	185.5	200.1
	EM3	EM4	EM3	EM2	EM4	EM1	EM3	EM2	EM1	EM2	EM1
20	65,600	91,400									
25	65,600	91,400	65,300	57,200	73,000	41,200					
30	65,600	85,500	65,300	57,200	73,000	41,200	55,000	53,300	38,700	41,300	
35	61,700	79,100	64,100	54,500	73,000	41,200	55,000	53,300	38,700	41,300	33,000
40	57,000	73,500	59,600	49,800	69,700	41,200	55,000	52,200	38,700	41,300	33,000
45	52,800	68,600	55,600	45,700	63,800	41,200	55,000	48,200	38,700	41,300	33,000
50	49,100	64,100	52,100	41,900	58,600	40,500	53,500	44,300	38,700	41,300	33,000
55	45,800	59,700	48,900	38,800	54,100	37,600	50,500	41,300	38,700	41,300	33,000
60	42,700	51,900	46,100	36,000	50,100	34,900	47,600	38,500	37,200	40,200	33,000
65	40,100	45,800	43,200	33,600	44,500	32,500	44,300	36,100	34,800	37,800	33,000
70	37,700	40,600	40,800	31,300	39,400	30,400	40,100	33,800	32,700	35,600	33,000
75	35,600	36,200	36,900	29,300	35,000	28,500	35,700	31,800	30,700	33,700	32,600
80	33,700	32,700	33,400	27,500	31,500	26,700	32,200	30,000	29,000	31,200	30,800
85	31,600	29,500	30,200	25,900	28,300	25,100	29,000	28,300	27,300	28,000	28,900
90	28,800	26,700	27,400	24,400	25,600	23,700	26,300	26,200	25,800	25,300	26,100
95	26,300	24,300	24,900	23,000	23,100	22,200	23,800	23,700	24,400	22,800	23,700
100	24,100	22,100	22,800	21,600	21,000	21,000	21,700	21,600	22,400	20,700	21,500
105	22,100	20,100	20,800	20,400	19,100	19,900	19,700	19,700	20,500	18,800	19,600
110	20,300	18,400	19,100	19,000	17,300	18,900	18,000	17,900	18,800	17,100	17,900
115	18,700	16,900	17,500	17,400	15,900	17,900	16,700	16,600	17,200	15,700	16,600
120	17,300	15,500	16,200	16,100	14,500	17,000	15,200	15,200	16,000	14,300	15,200
125	16,100	14,200	14,900	14,800	13,200	15,700	13,900	13,900	14,700	13,000	13,900
130			13,700	13,600	12,000	14,500	12,700	12,700	13,500	11,900	12,700
135			12,600	12,500	10,900	13,400	11,600	11,600	12,400	10,800	11,600
140			11,600	11,500	9,900	12,400	10,600	10,500	11,400	9,800	10,600
145						11,400	9,700	9,600	10,500	8,800	9,700
150						10,600	8,800	8,800	9,600	8,000	8,800
155						9,800	8,000	8,000	8,800	7,200	8,000
160								7,200	8,100	6,400	7,300
165									7,400	5,700	6,600
170									6,700	5,100	5,900
175										4,500	5,300
180											4,700
185											4,200
Unpinned	65,600	63,400	65,200	57,200	63,200	41,200	55,000	53,300	38,700	41,300	33,000
Min Angle	0.0	0.0	0.0	0.0	0.0	0.0	0.0	0.0	0.0	0.0	12.5
Max Rad.	126.9	128.3	143.4	143.9	144.8	158.5	159.9	160.4	175.1	177.0	190.0
Capacity	6,400	5,300	4,500	7,000	3,500	4,000	2,900	4,800	2,500	2,900	0

1060010



PORTLAND OFFICE: 503.283.3111
 SEATTLE OFFICE: 206.784.1054
WWW.NESSCAMPBELL.COM

Rated Lifting Capacities in Pounds

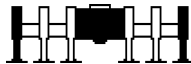

Full

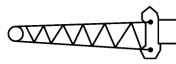

12ft Offset Fly
2° - 45°



80,000 lbs



Boom Length (ft)											
Extend Mode											
Radius (ft)	44.3	58.9	59.4	59.9	73.5	74.0	75.0	75.9	88.7	89.1	89.6
	ALL	EM2, EM5	EM6	EM7	EM1, EM3, EM4	EM5	EM6	EM7	EM4	EM2	EM5
10	69,600	69,500	69,500	69,500	69,400	69,400	69,400	69,400	69,400	69,400	69,300
12	69,600	69,500	69,500	69,500	69,400	69,400	69,400	69,400	69,400	69,400	69,300
15	69,600	69,500	69,500	69,500	69,400	69,400	69,400	69,400	69,400	69,400	69,300
20	69,600	69,500	69,500	69,500	69,400	69,400	69,400	69,400	69,400	69,400	69,300
25	69,600	69,500	69,500	69,500	69,400	69,400	69,400	69,400	69,400	69,400	69,300
30	66,700	69,500	69,500	69,500	64,100	69,400	69,400	69,400	63,700	62,300	69,300
35	61,800	69,400	69,500	69,500	57,500	69,400	69,400	69,400	57,200	56,000	69,300
40	57,700	66,200	69,500	69,500	51,300	69,400	69,400	69,400	51,900	50,700	69,300
45	54,700	62,300	65,800	66,100	46,300	68,600	69,400	69,400	47,400	46,300	69,300
50		59,000	62,200	62,400	42,600	66,000	68,700	66,500	43,900	42,600	69,300
55		55,900	58,800	57,600	39,000	60,700	58,900	56,700	40,600	38,900	60,500
60		52,200	51,200	50,000	35,900	52,900	51,300	49,100	37,700	35,800	52,700
65					33,200	46,700	45,000	42,900	35,100	33,000	46,500
70					30,900	41,500	39,900	37,900	32,900	30,600	41,300
75					28,900	37,300	35,600	33,700	30,900	28,500	36,900
80									29,100	26,600	33,400
85									27,600	25,000	30,200
90									26,200	23,500	27,500
Unpinned		69,500	69,500	69,500	55,600	69,400	69,400	69,400	69,400	56,000	69,300
Min Angle	0.0	0.0	0.0	0.0	0.0	0.0	0.0	0.0	0.0	0.0	0.0
Max Rad.	46.4	61.0	61.5	61.9	75.6	76.1	77.0	78.0	90.7	91.2	91.7
Capacity	30,500	14,600	25,100	24,400	7,900	12,500	20,600	19,300	6,800	10,700	10,400

1063010



PORTLAND OFFICE: 503.283.3111
 SEATTLE OFFICE: 206.784.1054
WWW.NESSCAMPBELL.COM

Rated Lifting Capacities in Pounds

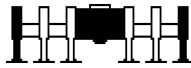

Full

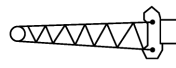

12ft Offset Fly
2° - 45°



80,000 lbs



360°

		Boom Length (ft)										
		Extend Mode										
Radius (ft)	91.0	92.5	103.8	104.2	105.7	107.6	119.4	120.3	120.3	122.2	124.1	134.9
	EM6	EM7	EM1, EM3	EM4	EM5	EM6	EM3	EM4	EM2	EM5	EM6	EM1
10	69,300	69,300										
12	69,300	69,300										
15	69,300	69,300	62,700	69,300	69,300	69,200	54,600	69,200	61,000	69,200	69,100	
20	69,300	69,300	62,700	69,300	69,300	69,200	54,600	69,200	61,000	69,200	69,100	42,600
25	69,300	69,300	61,800	69,300	69,300	69,200	54,600	69,200	61,000	69,200	69,100	42,600
30	69,300	69,300	55,000	68,300	69,300	69,200	54,600	69,200	58,300	69,200	69,100	42,600
35	69,300	69,300	49,400	62,100	69,300	69,200	52,600	66,100	52,500	69,200	69,100	42,600
40	69,300	69,300	45,000	56,700	69,300	69,200	48,000	60,800	47,700	69,200	69,100	42,600
45	69,300	69,300	41,100	52,100	69,300	69,200	44,300	56,200	43,700	69,200	69,100	41,000
50	67,800	64,500	37,700	48,200	69,300	65,900	40,900	52,200	40,100	67,400	63,500	37,700
55	58,000	54,800	34,800	45,000	59,400	56,100	37,900	48,700	37,000	57,600	54,700	34,800
60	50,400	47,300	32,200	42,000	51,800	48,600	35,300	45,700	34,300	50,000	47,200	32,200
65	44,100	41,100	30,000	39,300	45,500	42,400	33,000	43,100	31,900	43,800	41,100	29,900
70	39,000	36,100	27,900	37,000	40,300	37,300	31,000	40,600	29,700	38,600	36,000	27,900
75	34,800	31,900	25,900	34,800	36,000	33,100	29,100	37,000	27,800	34,500	31,900	26,000
80	31,100	28,300	24,200	32,900	32,400	29,400	27,400	33,400	26,000	30,800	28,200	24,400
85	27,900	25,200	22,600	31,200	29,200	26,300	25,700	30,200	24,500	27,600	25,100	22,900
90	25,200	22,500	21,500	28,400	26,400	23,600	24,200	27,400	23,100	24,800	22,400	21,700
95			20,100	25,900	24,000	21,200	22,800	25,000	21,800	22,400	20,000	20,400
100			18,900	23,800	21,900	19,100	21,800	22,800	20,600	20,300	17,900	19,300
105			17,900	22,000	20,000	17,300	20,600	20,900	19,500	18,400	16,100	18,200
110							19,500	19,200	18,500	16,800	14,400	17,300
115							18,600	17,700	17,500	15,300	12,900	16,400
120							17,500	16,400	16,600	13,900	11,500	15,500
125											10,300	14,700
130												14,000
135												13,400
Unpinned	69,300	60,200	60,700	69,300	69,300	61,400	54,600	69,200	60,700	61,800	44,600	42,600
Min Angle	0.0	0.0	0.0	0.0	0.0	0.0	0.0	0.0	0.0	0.0	0.0	0.0
Max Rad.	93.1	94.5	105.8	106.3	107.7	109.7	121.4	122.4	122.4	124.3	126.2	137.0
Capacity	16,000	14,000	5,900	5,600	8,100	11,600	4,800	4,200	7,200	5,700	8,000	3,800

1063010



PORTLAND OFFICE: 503.283.3111
 SEATTLE OFFICE: 206.784.1054
WWW.NESSCAMPBELL.COM

Rated Lifting Capacities in Pounds

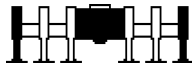

Full

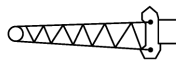

12ft Offset Fly
2° - 45°



80,000 lbs



Boom Length (ft)											
Extend Mode											
Radius (ft)	135.4	136.8	152.0	152.4	153.4	167.1	168.5	169.0	183.6	185.5	200.1
	EM3	EM4	EM3	EM2	EM4	EM1	EM3	EM2	EM1	EM2	EM1
25	55,600	69,100	55,000	49,300	59,000	35,100	43,000	42,100			
30	55,600	69,100	55,000	49,100	59,000	35,100	43,000	42,100	32,900	35,400	
35	55,600	68,900	55,000	49,100	59,000	35,100	43,000	42,100	32,900	35,400	28,100
40	51,100	63,800	53,400	47,200	59,000	35,100	43,000	42,100	32,900	35,400	28,100
45	47,200	59,300	49,600	43,200	59,000	35,100	43,000	42,100	32,900	35,400	28,100
50	43,900	55,400	46,300	39,700	56,500	35,100	43,000	41,800	32,900	35,400	28,100
55	40,900	52,000	43,300	36,600	52,000	35,100	43,000	38,800	32,900	35,400	28,100
60	38,200	48,900	40,700	33,900	48,100	32,800	42,100	36,100	32,900	35,400	28,100
65	35,900	44,900	38,300	31,400	43,500	30,400	39,800	33,700	32,500	35,200	28,100
70	33,800	39,700	36,200	29,300	38,400	28,300	37,800	31,500	30,400	33,100	28,100
75	31,900	35,300	34,300	27,300	34,300	26,400	34,500	29,500	28,500	31,100	28,100
80	30,200	31,800	32,300	25,500	30,600	24,700	31,100	27,700	26,700	29,400	28,100
85	28,600	28,600	29,100	23,900	27,400	23,100	27,900	26,000	25,100	26,900	26,800
90	27,100	25,900	26,300	22,400	24,600	21,800	25,100	24,500	23,700	24,100	24,800
95	25,300	23,400	23,900	21,000	22,200	20,500	22,700	22,600	22,300	21,700	22,400
100	23,200	21,300	21,700	19,800	20,100	19,300	20,600	20,500	21,100	19,500	20,200
105	21,200	19,400	19,800	18,600	18,100	18,100	18,600	18,600	19,300	17,600	18,300
110	19,500	17,700	18,100	17,600	16,600	17,100	17,000	17,100	17,600	16,200	16,900
115	17,900	16,300	16,700	16,600	15,100	16,100	15,600	15,500	16,200	14,600	15,300
120	16,700	14,900	15,300	15,200	13,700	15,200	14,200	14,100	14,800	13,200	13,900
125	15,400	13,600	14,000	13,900	12,400	14,400	12,900	12,800	13,500	11,900	12,600
130	14,200	12,400	12,800	12,800	11,200	13,400	11,700	11,700	12,400	10,800	11,500
135	13,200	11,400	11,800	11,700	10,200	12,400	10,700	10,600	11,300	9,700	10,400
140			10,800	10,700	9,200	11,400	9,700	9,600	10,300	8,700	9,400
145			9,900	9,800	8,300	10,500	8,800	8,700	9,400	7,800	8,500
150				9,000	7,500	9,600	7,900	7,900	8,500	7,000	7,600
155						8,800	7,200	7,100	7,800	6,200	6,900
160						8,100	6,400	6,400	7,000	5,500	6,100
165							5,800	5,700	6,400	4,800	5,500
170								5,100	5,700	4,200	4,800
175									5,100	3,600	4,200
180									4,600	3,000	3,700
185											3,200
190											2,700
195											2,200
Unpinned	55,600	63,400	55,000	49,300	59,000	35,100	43,000	42,100	32,900	35,400	28,100
Min Angle	0.0	0.0	18.0	0.0	10.0	17.5	10.0	0.0	10.5	14.0	16.5
Max Rad.	137.5	138.9	150.0	154.5	155.0	165.0	170.0	171.0	185.0	185.0	197.5
Capacity	3,500	2,600	0	3,900	0	0	0	2,200	0	0	0

1063010



PORTLAND OFFICE: 503.283.3111
SEATTLE OFFICE: 206.784.1054
WWW.NESSCAMPBELL.COM

Rated Lifting Capacities in Pounds

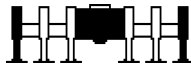

Full

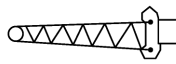

40ft Offset Fly



80,000 lbs



Radius (ft)	Boom Length (ft)											
	Fly Offset											
	44.3				73.5				103.8			
	2°	15°	30°	45°	2°	15°	30°	45°	2°	15°	30°	45°
10	34,700											
12	34,700				34,600							
15	34,700	34,700			34,600							
20	34,700	32,000			34,600	34,600			34,500			
25	33,900	28,800	24,900		34,600	32,900			34,500			
30	30,200	26,200	22,900	20,200	34,600	30,300	25,100		34,500	33,500		
35	27,200	24,000	20,700	19,000	34,500	28,100	23,600	20,300	34,500	31,400	25,200	
40	24,800	21,400	19,400	18,000	31,600	26,200	21,700	19,500	34,500	29,500	24,000	20,400
45	21,900	19,900	18,200	17,200	29,100	24,600	20,700	18,700	34,500	27,800	23,000	19,700
50	20,200	18,600	17,300	16,400	27,000	23,100	19,700	18,000	32,500	26,300	21,500	19,100
55	18,800	17,500	16,400	15,800	25,100	21,200	18,900	17,400	30,400	25,000	20,700	18,500
60	17,500	16,500	15,700	15,300	23,500	20,100	18,100	16,900	28,600	23,800	20,000	18,000
65	16,400	15,600	15,000	14,900	21,400	19,200	17,400	16,400	26,700	22,700	19,300	17,500
70	15,400	14,900	14,600		20,200	18,300	16,800	15,900	24,800	21,200	18,600	17,100
75	14,500	14,300			19,200	17,500	16,200	15,600	23,200	20,400	18,000	16,700
80					18,200	16,800	15,700	15,300	22,000	19,600	17,500	16,400
85					17,300	16,100	15,300	15,000	20,600	18,800	17,000	16,000
90					16,500	15,500	14,900		19,400	18,200	16,600	15,700
95					15,700	15,000	14,600		18,100	17,600	16,200	15,500
100					15,100	14,600			17,000	17,000	15,800	15,300
105					9,500				16,000	16,000	15,400	15,100
110									15,100	15,100	15,100	14,900
115									14,300	14,300	14,300	
120									13,500	13,500	13,500	
125									12,800	12,800	12,800	
130									12,200	12,200		
135									8,800			
Min Angle	0.0	0.0	0.0	0.0	0.0	0.0	0.0	0.0	0.0	0.0	0.0	0.0
Max Rad.	75.9	75.8	74.5	71.9	105.1	104.9	103.2	100.0	135.3	135.1	133.1	129.6
Capacity	11,200	11,400	12,100	13,600	3,700	3,700	3,900	4,200	2,600	2,600	2,700	2,900

1061040



PORTLAND OFFICE: 503.283.3111
 SEATTLE OFFICE: 206.784.1054
WWW.NESSCAMPBELL.COM

Rated Lifting Capacities in Pounds

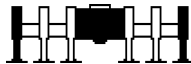

Full

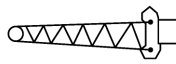

40ft Offset Fly



80,000 lbs



Radius (ft)	Boom Length (ft)											
	Fly Offset											
	134.9				167.1				183.6			
	2°	15°	30°	45°	2°	15°	30°	45°	2°	15°	30°	45°
25	29,700											
30	29,700				19,800							
35	29,700	29,500			19,800				18,600			
40	29,700	29,500			19,800	19,700			18,600			
45	29,700	29,500	24,300		19,800	19,700			18,600	18,500		
50	29,700	29,000	23,400	19,900	19,800	19,700	19,600		18,600	18,500		
55	29,700	27,700	22,100	19,300	19,800	19,700	19,600		18,600	18,500	18,300	
60	29,700	26,400	21,400	18,900	19,800	19,700	19,600	19,300	18,600	18,500	18,300	18,000
65	27,800	25,300	20,700	18,400	19,800	19,700	19,600	19,100	18,600	18,500	18,300	18,000
70	25,800	24,300	20,100	18,000	19,800	19,700	19,600	18,700	18,600	18,500	18,300	18,000
75	24,100	23,400	19,600	17,600	19,800	19,700	19,600	18,400	18,600	18,500	18,300	18,000
80	22,500	22,000	19,000	17,300	19,800	19,700	19,600	18,000	18,600	18,500	18,300	18,000
85	21,300	21,200	18,500	17,000	19,800	19,700	19,600	17,700	18,600	18,500	18,300	18,000
90	20,000	19,900	18,000	16,600	19,800	19,700	19,300	17,400	18,600	18,500	18,300	17,700
95	18,800	18,800	17,600	16,400	19,300	19,400	18,900	17,100	18,600	18,500	18,300	17,500
100	17,700	17,700	17,200	16,100	18,200	18,300	18,300	16,900	18,600	18,500	18,300	17,200
105	16,700	16,700	16,700	15,800	17,100	17,200	17,300	16,600	18,500	18,500	18,300	16,900
110	15,800	15,800	15,800	15,600	16,100	16,200	16,300	16,400	17,500	17,500	17,500	16,700
115	15,000	15,000	15,000	15,000	15,200	15,300	15,400	15,500	16,600	16,600	16,600	16,500
120	14,200	14,200	14,200	14,200	14,300	14,500	14,600	14,700	15,700	15,700	15,800	15,800
125	13,500	13,500	13,500	13,500	13,500	13,700	13,800	13,900	14,400	14,900	15,000	15,000
130	12,800	12,800	12,800	12,900	12,800	12,900	13,100	13,100	13,200	13,900	14,200	14,300
135	12,100	12,200	12,200	12,200	12,100	12,200	12,400	12,400	12,200	12,700	13,200	13,600
140	11,500	11,600	11,600		11,400	11,600	11,700	11,800	11,100	11,700	12,200	12,500
145	11,000	11,000	11,100		10,800	10,900	11,100	11,100	10,200	10,700	11,100	11,400
150	10,500	10,500	10,500		10,200	10,400	10,500	10,500	9,300	9,800	10,200	10,500
155	10,000	10,000	10,000		9,600	9,800	9,900	10,000	8,500	9,000	9,300	9,500
160	9,500	9,600			8,900	9,200	9,400	9,400	7,800	8,200	8,500	8,700
165					8,200	8,500	8,700	8,700	7,100	7,500	7,800	7,900
170					7,500	7,800	8,000		6,400	6,800	7,100	7,200
175					6,900	7,100	7,300		5,800	6,100	6,400	6,500
180					6,300	6,500	6,600		5,300	5,600	5,800	
185					5,800	6,000	6,000		4,700	5,000	5,200	
190					5,300	5,400			4,200	4,500	4,600	
195									3,800	4,000	4,100	
200									3,300	3,500	3,500	
205									2,900	3,000		
210									2,500			
Min Angle	13.5	15.0	23.5	4.0	16.5	18.0	15.5	20.5	15.0	19.5	18.5	22.0
Max Rad.	165.0	165.0	160.0	158.4	195.0	195.0	195.0	190.0	211.4	210.0	210.0	205.0
Capacity	0	0	0	0	0	0	0	0	0	0	0	0

1061040



PORTLAND OFFICE: 503.283.3111
 SEATTLE OFFICE: 206.784.1054
WWW.NESSCAMPBELL.COM

Rated Lifting Capacities in Pounds

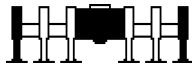

Full

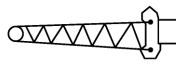

40ft Offset Fly



80,000 lbs



Radius (ft)	Boom Length (ft)			
	Fly Offset			
	200.1			
	2°	15°	30°	45°
40	16,100			
45	16,100			
50	16,100	16,100		
55	16,100	16,100		
60	16,100	16,100	15,900	
65	16,100	16,100	15,900	15,600
70	16,100	16,100	15,900	15,600
75	16,100	16,100	15,900	15,600
80	16,100	16,100	15,900	15,600
85	16,100	16,100	15,900	15,600
90	16,100	16,100	15,900	15,600
95	16,100	16,100	15,900	15,600
100	16,100	16,100	15,900	15,600
105	16,100	16,100	15,900	15,600
110	16,100	16,100	15,900	15,600
115	16,100	16,100	15,900	15,600
120	14,800	15,600	15,900	15,600
125	13,500	14,200	14,900	15,400
130	12,300	13,000	13,600	14,100
135	11,200	11,800	12,400	12,900
140	10,200	10,800	11,400	11,700
145	9,300	9,800	10,400	10,700
150	8,400	8,900	9,400	9,700
155	7,600	8,100	8,600	8,800
160	6,900	7,300	7,700	8,000
165	6,200	6,600	7,000	7,200
170	5,500	5,900	6,300	6,500
175	4,900	5,300	5,600	5,800
180	4,400	4,700	5,000	5,100
185	3,800	4,100	4,400	4,500
190	3,300	3,600	3,800	3,900
195	2,800	3,100	3,300	
200	2,400	2,600	2,800	
205		2,200	2,300	
Min Angle	33.0	33.5	33.5	33.5
Max Rad. Capacity	205.0	207.5	208.8	208.0
	0	0	0	0

1061040



PORTLAND OFFICE: 503.283.3111
 SEATTLE OFFICE: 206.784.1054
WWW.NESSCAMPBELL.COM

Rated Lifting Capacities in Pounds

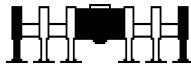

Full

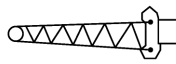

40ft Offset Fly



80,000 lbs



Radius (ft)	Boom Length (ft)											
	Fly Offset											
	44.3				58.9				89.1			
	2°	15°	30°	45°	2°	15°	30°	45°	2°	15°	30°	45°
10	34,700				34,700							
12	34,700				34,700							
15	34,700	34,700			34,700				34,600			
20	34,700	32,000			34,700	34,200			34,600			
25	33,900	28,800	24,900		34,700	31,100	25,900		34,600	34,600		
30	30,200	26,200	22,900	20,200	34,200	28,400	24,100		34,600	32,100	25,900	
35	27,200	24,000	20,700	19,000	31,000	26,200	21,900	19,800	34,600	29,900	24,500	
40	24,800	21,400	19,400	18,000	28,300	24,300	20,700	18,800	34,600	28,000	23,300	20,000
45	21,900	19,900	18,200	17,200	26,000	22,000	19,600	18,000	32,200	26,300	21,700	19,300
50	20,200	18,600	17,300	16,400	24,000	20,600	18,600	17,300	29,900	24,900	20,700	18,600
55	18,800	17,500	16,400	15,800	21,600	19,500	17,800	16,700	27,900	23,600	19,900	18,000
60	17,500	16,500	15,700	15,300	20,200	18,400	17,000	16,100	26,200	21,800	19,100	17,500
65	16,400	15,600	15,000	14,900	19,000	17,500	16,300	15,700	24,600	20,800	18,400	17,000
70	15,400	14,900	14,600		17,900	16,700	15,700	15,300	23,300	19,900	17,800	16,600
75	14,500	14,300			16,900	15,900	15,200	15,000	21,400	19,000	17,200	16,200
80					16,000	15,300	14,800		20,400	18,300	16,700	15,800
85					15,200	14,700	14,500		19,400	17,600	16,200	15,500
90					14,500				18,500	16,900	15,800	15,300
95									17,700	16,400	15,400	15,100
100									17,000	15,800	15,100	14,900
105									16,300	15,300	14,800	
110									15,700	14,900	14,600	
115									15,100	14,600		
120									14,500			
Min Angle	0.0	0.0	0.0	0.0	0.0	0.0	0.0	0.0	0.0	0.0	0.0	0.0
Max Rad. Capacity	75.9	75.8	74.5	71.9	90.5	90.4	88.8	85.9	120.7	120.5	118.6	115.2
Capacity	11,200	11,400	12,100	13,600	6,600	6,700	7,000	7,700	4,900	5,000	5,200	5,700

1061050



PORTLAND OFFICE: 503.283.3111
 SEATTLE OFFICE: 206.784.1054
WWW.NESSCAMPBELL.COM

Rated Lifting Capacities in Pounds

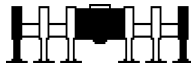

Full

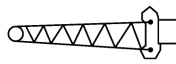

40ft Offset Fly



80,000 lbs



Radius (ft)	Boom Length (ft)											
	Fly Offset											
	120.3				152.4				169.0			
	2°	15°	30°	45°	2°	15°	30°	45°	2°	15°	30°	45°
25	34,500											
30	34,500				31,300							
35	34,500	32,800			31,300							
40	34,500	30,900			31,300				29,200			
45	34,500	29,300	23,700		31,300	31,200			29,200			
50	34,500	27,800	22,800	19,500	31,300	30,300	24,000		29,200	29,100		
55	33,100	26,500	21,500	19,000	31,300	28,900	23,200		29,200	29,100	23,800	
60	31,200	25,300	20,800	18,500	31,300	27,700	22,000	19,300	29,200	28,800	23,100	
65	29,300	24,200	20,100	18,000	29,700	26,600	21,400	18,800	29,200	27,700	22,000	19,200
70	27,300	23,200	19,500	17,600	27,600	25,600	20,800	18,400	29,200	26,700	21,400	18,800
75	25,500	21,700	18,900	17,200	25,700	24,600	20,200	18,100	27,500	25,700	20,800	18,400
80	23,800	20,900	18,300	16,900	24,000	23,700	19,700	17,700	25,800	24,800	20,300	18,100
85	22,500	20,200	17,900	16,500	22,500	22,500	19,200	17,400	24,200	24,000	19,800	17,800
90	21,100	19,500	17,400	16,200	21,100	21,200	18,800	17,100	22,800	22,600	19,400	17,400
95	19,900	18,800	17,000	16,000	19,800	19,900	18,300	16,800	21,400	21,300	18,900	17,200
100	18,800	18,200	16,600	15,700	18,700	18,700	17,900	16,500	20,200	20,100	18,500	16,900
105	17,800	17,700	16,200	15,500	17,600	17,700	17,500	16,300	19,100	19,000	18,100	16,600
110	16,800	16,800	15,800	15,300	16,600	16,700	16,800	16,000	18,000	18,000	17,800	16,400
115	15,900	15,900	15,600	15,100	15,600	15,700	15,800	15,800	16,700	17,100	17,100	16,200
120	15,100	15,100	15,100	15,000	14,800	14,900	15,000	15,100	15,300	16,000	16,200	16,000
125	14,400	14,400	14,400	14,400	13,900	14,100	14,200	14,200	14,000	14,600	15,200	15,500
130	13,700	13,700	13,700		13,200	13,300	13,400	13,500	12,800	13,400	14,000	14,300
135	13,000	13,000	13,000		12,500	12,600	12,700	12,800	11,700	12,300	12,800	13,100
140	12,400	12,400	12,400		11,800	11,900	12,000	12,100	10,700	11,200	11,700	11,900
145	11,800	11,800			10,900	11,300	11,400	11,400	9,800	10,200	10,700	10,900
150	11,300	11,300			10,000	10,400	10,700	10,700	8,900	9,400	9,700	9,900
155					9,200	9,500	9,800		8,100	8,500	8,900	9,000
160					8,500	8,800	8,900		7,400	7,700	8,000	8,100
165					7,800	8,000	8,200		6,700	7,000	7,300	7,300
170					7,200	7,300	7,400		6,000	6,300	6,500	
175					6,600	6,700			5,400	5,700	5,900	
180									4,900	5,100	5,200	
185									4,300	4,500	4,600	
190									3,800	4,000		
195									3,400	3,500		
Min Angle	0.0	0.0	0.0	0.0	17.0	18.5	17.0	22.0	9.0	7.0	19.0	22.5
Max Rad.	151.9	151.6	149.6	145.9	180.0	180.0	180.0	175.0	200.0	199.9	195.0	190.0
Capacity	3,200	3,200	3,400	3,700	0	0	0	0	0	0	0	0

1061050



PORTLAND OFFICE: 503.283.3111
 SEATTLE OFFICE: 206.784.1054
WWW.NESSCAMPBELL.COM

Rated Lifting Capacities in Pounds

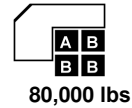
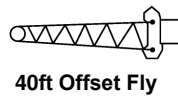
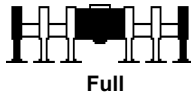

Radius (ft)	Boom Length (ft)			
	Fly Offset			
	185.5			
	2°	15°	30°	45°
40	20,200			
45	20,200			
50	20,200	20,100		
55	20,200	20,100		
60	20,200	20,100	19,900	
65	20,200	20,100	19,900	
70	20,200	20,100	19,900	19,100
75	20,200	20,100	19,900	18,700
80	20,200	20,100	19,900	18,400
85	20,200	20,100	19,900	18,100
90	20,200	20,100	19,900	17,800
95	20,200	20,100	19,500	17,500
100	20,200	20,100	19,100	17,200
105	18,800	19,700	18,700	17,000
110	17,000	17,900	18,300	16,700
115	15,800	16,600	17,100	16,500
120	14,300	15,100	15,800	16,300
125	13,000	13,700	14,400	14,900
130	11,800	12,500	13,100	13,600
135	10,800	11,400	12,000	12,400
140	9,800	10,300	10,900	11,200
145	8,800	9,400	9,900	10,200
150	8,000	8,500	8,900	9,200
155	7,200	7,600	8,100	8,300
160	6,400	6,900	7,200	7,400
165	5,700	6,100	6,500	6,600
170	5,100	5,500	5,800	5,900
175	4,500	4,800	5,100	5,200
180	3,900	4,200	4,500	
185	3,400	3,700	3,900	
190	2,900	3,100	3,300	
195	2,400	2,600	2,800	
200		2,200	2,200	
Min Angle	28.0	28.0	28.5	28.0
Max Rad.	200.0	202.0	202.0	201.0
Capacity	0	0	0	0

1061050



PORTLAND OFFICE: 503.283.3111
 SEATTLE OFFICE: 206.784.1054
WWW.NESSCAMPBELL.COM

Rated Lifting Capacities in Pounds

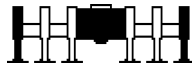

Full

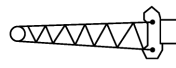

40ft Offset Fly



80,000 lbs



Radius (ft)	Boom Length (ft)											
	Fly Offset											
	44.3				73.5				103.8			
	2°	15°	30°	45°	2°	15°	30°	45°	2°	15°	30°	45°
10	34,700											
12	34,700				34,600							
15	34,700	34,700			34,600							
20	34,700	32,000			34,600	34,600			34,500			
25	33,900	28,800	24,900		34,600	32,900			34,500			
30	30,200	26,200	22,900	20,200	34,600	30,300	25,100		34,500	33,500		
35	27,200	24,000	20,700	19,000	34,500	28,100	23,600	20,300	34,500	31,400	25,200	
40	24,800	21,400	19,400	18,000	31,600	26,200	21,700	19,500	34,500	29,500	24,000	20,400
45	21,900	19,900	18,200	17,200	29,100	24,600	20,700	18,700	34,500	27,800	23,000	19,700
50	20,200	18,600	17,300	16,400	27,000	23,100	19,700	18,000	32,500	26,300	21,500	19,100
55	18,800	17,500	16,400	15,800	25,100	21,200	18,900	17,400	30,400	25,000	20,700	18,500
60	17,500	16,500	15,700	15,300	23,500	20,100	18,100	16,900	28,600	23,800	20,000	18,000
65	16,400	15,600	15,000	14,900	21,400	19,200	17,400	16,400	26,700	22,700	19,300	17,500
70	15,400	14,900	14,600		20,200	18,300	16,800	15,900	24,800	21,200	18,600	17,100
75	14,500	14,300			19,200	17,500	16,200	15,600	23,200	20,400	18,000	16,700
80					18,200	16,800	15,700	15,300	22,000	19,600	17,500	16,400
85					17,300	16,100	15,300	15,000	20,600	18,800	17,000	16,000
90					16,500	15,500	14,900		19,400	18,200	16,600	15,700
95					15,700	15,000	14,600		18,100	17,600	16,200	15,500
100					15,100	14,600			17,000	17,000	15,800	15,300
105					9,500				16,000	16,000	15,400	15,100
110									15,100	15,100	15,100	14,900
115									14,300	14,300	14,300	
120									13,500	13,500	13,500	
125									12,800	12,800	12,800	
130									12,200	12,200		
135									8,800			
Min Angle	0.0	0.0	0.0	0.0	0.0	0.0	0.0	0.0	0.0	0.0	0.0	0.0
Max Rad.	75.9	75.8	74.5	71.9	105.1	104.9	103.2	100.0	135.3	135.1	133.1	129.6
Capacity	11,200	11,400	12,100	13,600	3,700	3,700	3,900	4,200	2,600	2,600	2,700	2,900

1061060



PORTLAND OFFICE: 503.283.3111
 SEATTLE OFFICE: 206.784.1054
WWW.NESSCAMPBELL.COM

Rated Lifting Capacities in Pounds

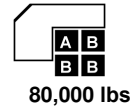
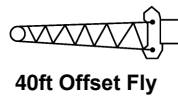
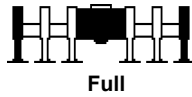

Radius (ft)	Boom Length (ft)											
	Fly Offset											
	119.4				135.4				152.0			
	2°	15°	30°	45°	2°	15°	30°	45°	2°	15°	30°	45°
25	33,900				34,400							
30	33,900				34,400				33,800			
35	33,900	32,700			34,400	33,900			33,800			
40	33,900	30,900	24,700		34,400	32,100			33,800	33,300		
45	33,900	29,200	23,700	20,100	34,400	30,500	24,300		33,800	31,700	24,900	
50	33,900	27,700	22,800	19,500	34,400	29,000	23,400	19,900	33,800	30,200	24,000	20,200
55	33,000	26,400	21,500	19,000	34,400	27,700	22,100	19,400	33,800	28,900	23,200	19,700
60	31,000	25,200	20,700	18,500	33,400	26,500	21,400	18,900	33,800	27,700	22,000	19,200
65	28,900	24,100	20,000	18,000	31,200	25,400	20,700	18,400	33,100	26,600	21,400	18,800
70	27,000	23,100	19,400	17,600	29,200	24,300	20,100	18,000	31,100	25,500	20,800	18,400
75	25,300	21,600	18,800	17,200	27,400	23,400	19,600	17,600	29,300	24,600	20,200	18,000
80	23,800	20,800	18,300	16,900	25,800	22,000	19,000	17,300	27,700	23,700	19,700	17,700
85	22,500	20,100	17,800	16,500	24,400	21,300	18,500	17,000	26,200	22,900	19,200	17,400
90	21,300	19,400	17,300	16,200	23,100	20,600	18,100	16,700	24,800	21,700	18,700	17,100
95	20,100	18,800	16,900	15,900	21,900	19,900	17,600	16,400	23,600	21,000	18,300	16,800
100	19,100	18,200	16,500	15,700	20,800	19,300	17,200	16,100	22,400	20,400	17,900	16,500
105	18,000	17,600	16,100	15,500	19,800	18,700	16,800	15,900	21,000	19,800	17,500	16,300
110	17,000	16,800	15,800	15,300	18,900	18,200	16,500	15,600	19,300	19,200	17,100	16,000
115	16,100	16,000	15,500	15,100	17,900	17,600	16,200	15,500	17,700	18,300	16,800	15,800
120	15,300	15,200	15,100	15,000	17,100	16,800	15,800	15,300	16,500	17,100	16,500	15,600
125	14,500	14,400	14,400	14,400	16,200	16,000	15,600	15,100	15,200	15,700	16,200	15,500
130	13,800	13,800	13,700		15,300	15,300	15,200	15,000	14,000	14,500	15,000	15,200
135	13,200	13,100	13,100		14,200	14,600	14,500	14,500	12,900	13,400	13,800	14,000
140	12,600	12,500	12,500		13,200	13,500	13,800		11,900	12,300	12,700	12,800
145	12,000	12,000			12,300	12,600	12,800		11,000	11,300	11,700	11,800
150					11,400	11,700	11,800		10,100	10,400	10,700	10,800
155					10,600	10,800	10,900		9,300	9,600	9,800	
160					9,900	10,000			8,600	8,800	9,000	
165									7,900	8,100	8,200	
170									7,200	7,400	7,500	
175									6,600	6,800		
Min Angle	11.5	13.0	0.0	0.0	14.0	15.5	23.5	3.5	15.5	17.5	15.0	20.0
Max Rad.	150.0	150.0	148.6	144.9	165.0	165.0	160.0	158.9	180.0	180.0	180.0	175.0
Capacity	0	0	2,000	2,200	0	0	0	0	0	0	0	0

1061060



PORTLAND OFFICE: 503.283.3111
 SEATTLE OFFICE: 206.784.1054
WWW.NESSCAMPBELL.COM

Rated Lifting Capacities in Pounds

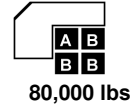
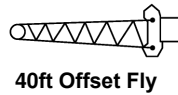
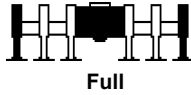

Radius (ft)	Boom Length (ft)			
	Fly Offset			
	168.5			
	2°	15°	30°	45°
35	29,200			
40	29,200			
45	29,200	29,000		
50	29,200	29,000		
55	29,200	29,000	23,800	
60	29,200	28,800	23,100	19,600
65	29,200	27,700	22,000	19,200
70	29,200	26,600	21,400	18,800
75	29,200	25,700	20,800	18,400
80	29,100	24,800	20,300	18,100
85	27,600	24,000	19,800	17,700
90	26,200	23,200	19,300	17,400
95	24,000	22,000	18,900	17,100
100	21,800	21,400	18,500	16,900
105	19,800	20,700	18,100	16,600
110	18,100	18,900	17,700	16,400
115	16,800	17,300	17,400	16,200
120	15,400	16,000	16,700	16,000
125	14,100	14,700	15,300	15,700
130	12,900	13,500	14,000	14,400
135	11,800	12,300	12,800	13,100
140	10,800	11,300	11,700	12,000
145	9,800	10,300	10,700	10,900
150	9,000	9,400	9,800	10,000
155	8,200	8,600	8,900	9,000
160	7,400	7,800	8,100	8,200
165	6,700	7,100	7,300	
170	6,100	6,400	6,600	
175	5,500	5,700	5,900	
180	4,900	5,100	5,300	
185	4,400	4,600	4,700	
190	3,900	4,000		
195	3,400			
Min Angle	12.0	19.0	18.0	21.5
Max Rad.	197.2	195.0	195.0	190.0
Capacity	0	0	0	0

1061060



PORTLAND OFFICE: 503.283.3111
 SEATTLE OFFICE: 206.784.1054
WWW.NESSCAMPBELL.COM

Rated Lifting Capacities in Pounds

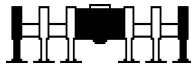

Full

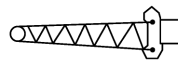

40ft Hydraulic Offset Fly



80,000 lbs



Radius (ft)	Boom Length (ft)											
	Fly Offset											
	44.3			73.5			103.8			134.9		
	2°-15°	15°-30°	30°-45°	2°-15°	15°-30°	30°-45°	2°-15°	15°-30°	30°-45°	2°-15°	15°-30°	30°-45°
10	34,700											
12	34,700	34,700		34,600								
15	34,700	34,700		34,600								
20	32,000	27,100	27,100	34,600	34,600		34,500					
25	28,800	24,900	24,900	32,900	32,900		34,500	34,500		29,700		
30	26,200	22,900	20,200	30,300	25,100	25,100	33,500	33,500		29,700		
35	24,000	20,700	19,000	28,100	23,600	20,300	31,400	25,200	25,200	29,500	29,500	
40	21,400	19,400	18,000	26,200	21,700	19,500	29,500	24,000	20,400	29,500	25,300	25,300
45	19,900	18,200	17,200	24,600	20,700	18,700	27,800	23,000	19,700	29,500	24,300	20,400
50	18,600	17,300	16,400	23,100	19,700	18,000	26,300	21,500	19,100	29,000	23,400	19,900
55	17,500	16,400	15,800	21,200	18,900	17,400	25,000	20,700	18,500	27,700	22,100	19,300
60	16,500	15,700	15,300	20,100	18,100	16,900	23,800	20,000	18,000	26,400	21,400	18,900
65	15,600	15,000	14,900	19,200	17,400	16,400	22,700	19,300	17,500	25,300	20,700	18,400
70	14,900	14,600	14,600	18,300	16,800	15,900	21,200	18,600	17,100	24,300	20,100	18,000
75	14,300	14,300		17,500	16,200	15,600	20,400	18,000	16,700	23,400	19,600	17,600
80				16,800	15,700	15,300	19,600	17,500	16,400	22,000	19,000	17,300
85				16,100	15,300	15,000	18,800	17,000	16,000	21,200	18,500	17,000
90				15,500	14,900	14,900	18,200	16,600	15,700	19,900	18,000	16,600
95				15,000	14,600	14,600	17,600	16,200	15,500	18,800	17,600	16,400
100				14,600	14,500		17,000	15,800	15,300	17,700	17,200	16,100
105				9,500			16,000	15,400	15,100	16,700	16,700	15,800
110							15,100	15,100	14,900	15,800	15,800	15,600
115							14,300	14,300	14,300	15,000	15,000	15,000
120							13,500	13,500	13,500	14,200	14,200	14,200
125							12,800	12,800	12,800	13,500	13,500	13,500
130							12,200	12,200		12,800	12,800	12,800
135							8,800			12,100	12,200	12,200
140										11,500	11,600	11,600
145										11,000	11,000	11,100
150										10,500	10,500	10,500
155										10,000	10,000	10,000
160										9,500		
Min Angle	0.0	0.0	0.0	0.0	0.0	0.0	0.0	0.0	0.0	13.5	23.5	4.0
Max Rad.	75.9	75.8	74.5	105.1	104.9	103.2	135.3	135.1	133.1	165.0	160.0	158.4
Capacity	11,200	11,400	12,100	3,700	3,700	3,900	2,600	2,600	2,700	0	0	0

1062040



PORTLAND OFFICE: 503.283.3111
 SEATTLE OFFICE: 206.784.1054
WWW.NESSCAMPBELL.COM

Rated Lifting Capacities in Pounds

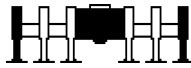

Full

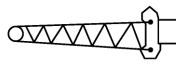

40ft Hydraulic Offset Fly



80,000 lbs



Radius (ft)	Boom Length (ft)								
	Fly Offset								
	167.1			183.6			200.1		
	2°-15°	15°-30°	30°-45°	2°-15°	15°-30°	30°-45°	2°-15°	15°-30°	30°-45°
30	19,800								
35	19,800			18,600					
40	19,700	19,700		18,400	18,400		16,100		
45	19,700	19,500	19,500	18,400	18,400		16,000	16,000	
50	19,700	19,500	19,500	18,400	18,400		16,000	16,000	
55	19,700	19,500	19,200	18,400	18,300	18,300	16,000	15,800	15,800
60	19,700	19,500	19,200	18,400	18,300	18,000	16,000	15,800	15,600
65	19,700	19,500	19,100	18,400	18,300	18,000	16,000	15,800	15,600
70	19,700	19,500	18,700	18,400	18,300	18,000	16,000	15,800	15,600
75	19,700	19,500	18,400	18,400	18,300	18,000	16,000	15,800	15,600
80	19,700	19,500	18,000	18,400	18,300	18,000	16,000	15,800	15,600
85	19,700	19,500	17,700	18,400	18,300	18,000	16,000	15,800	15,600
90	19,700	19,300	17,400	18,400	18,300	17,700	16,000	15,800	15,600
95	19,300	18,900	17,100	18,400	18,300	17,500	16,000	15,800	15,600
100	18,200	18,300	16,900	18,400	18,300	17,200	16,000	15,800	15,600
105	17,100	17,200	16,600	18,400	18,300	16,900	16,000	15,800	15,600
110	16,100	16,200	16,300	17,500	17,500	16,700	16,000	15,800	15,600
115	15,200	15,300	15,400	16,600	16,600	16,500	16,000	15,800	15,600
120	14,300	14,500	14,600	15,700	15,700	15,800	14,800	15,600	15,600
125	13,500	13,700	13,800	14,400	14,900	15,000	13,500	14,200	14,900
130	12,800	12,900	13,100	13,200	13,900	14,200	12,300	13,000	13,600
135	12,100	12,200	12,400	12,200	12,700	13,200	11,200	11,800	12,400
140	11,400	11,600	11,700	11,100	11,700	12,200	10,200	10,800	11,400
145	10,800	10,900	11,100	10,200	10,700	11,100	9,300	9,800	10,400
150	10,200	10,400	10,500	9,300	9,800	10,200	8,400	8,900	9,400
155	9,600	9,800	9,900	8,500	9,000	9,300	7,600	8,100	8,600
160	8,900	9,200	9,400	7,800	8,200	8,500	6,900	7,300	7,700
165	8,200	8,500	8,700	7,100	7,500	7,800	6,200	6,600	7,000
170	7,500	7,800	8,000	6,400	6,800	7,100	5,500	5,900	6,300
175	6,900	7,100	7,300	5,800	6,100	6,400	4,900	5,300	5,600
180	6,300	6,500	6,600	5,300	5,600	5,800	4,400	4,700	5,000
185	5,800	6,000	5,900	4,700	5,000	5,200	3,800	4,100	4,400
190	5,300	5,400		4,200	4,500	4,600	3,300	3,600	3,800
195				3,800	4,000	4,000	2,800	3,100	3,300
200				3,300	3,500	3,400	2,400	2,600	2,800
205				2,900	3,000			2,200	2,300
Min Angle	16.5	15.5	20.5	19.5	18.5	22.0	33.0	33.5	33.5
Max Rad. Capacity	195.0	195.0	190.0	210.0	210.0	205.0	205.0	207.5	208.0
	0	0	0	0	0	0	0	0	0

1062040



PORTLAND OFFICE: 503.283.3111
 SEATTLE OFFICE: 206.784.1054
WWW.NESSCAMPBELL.COM

Rated Lifting Capacities in Pounds

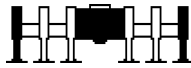

Full

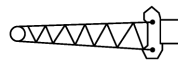

40ft Hydraulic Offset Fly



80,000 lbs



Radius (ft)	Boom Length (ft)											
	Fly Offset											
	44.3			58.9			89.1			120.3		
	2°-15°	15°-30°	30°-45°	2°-15°	15°-30°	30°-45°	2°-15°	15°-30°	30°-45°	2°-15°	15°-30°	30°-45°
10	34,700			34,700								
12	34,700	34,700		34,700								
15	34,700	34,700		34,700	34,700		34,600					
20	32,000	27,100	27,100	34,200	34,200		34,600	34,600				
25	28,800	24,900	24,900	31,100	25,900	25,900	34,600	34,600		34,500		
30	26,200	22,900	20,200	28,400	24,100	20,800	32,100	25,900	25,900	34,500	34,500	
35	24,000	20,700	19,000	26,200	21,900	19,800	29,900	24,500	20,800	32,800	25,800	25,800
40	21,400	19,400	18,000	24,300	20,700	18,800	28,000	23,300	20,000	30,900	24,700	24,700
45	19,900	18,200	17,200	22,000	19,600	18,000	26,300	21,700	19,300	29,300	23,700	20,100
50	18,600	17,300	16,400	20,600	18,600	17,300	24,900	20,700	18,600	27,800	22,800	19,500
55	17,500	16,400	15,800	19,500	17,800	16,700	23,600	19,900	18,000	26,500	21,500	19,000
60	16,500	15,700	15,300	18,400	17,000	16,100	21,800	19,100	17,500	25,300	20,800	18,500
65	15,600	15,000	14,900	17,500	16,300	15,700	20,800	18,400	17,000	24,200	20,100	18,000
70	14,900	14,600	14,600	16,700	15,700	15,300	19,900	17,800	16,600	23,200	19,500	17,600
75	14,300	14,300		15,900	15,200	15,000	19,000	17,200	16,200	21,700	18,900	17,200
80				15,300	14,800	14,800	18,300	16,700	15,800	20,900	18,300	16,900
85				14,700	14,500	14,500	17,600	16,200	15,500	20,200	17,900	16,500
90				14,300			16,900	15,800	15,300	19,500	17,400	16,200
95							16,400	15,400	15,100	18,800	17,000	16,000
100							15,800	15,100	14,900	18,200	16,600	15,700
105							15,300	14,800	14,800	17,700	16,200	15,500
110							14,900	14,600	14,600	16,800	15,800	15,300
115							14,600	14,500		15,900	15,600	15,100
120							14,400			15,100	15,100	15,000
125										14,400	14,400	14,400
130										13,700	13,700	13,700
135										13,000	13,000	13,000
140										12,400	12,400	12,400
145										11,800	11,800	
150										11,300	11,300	
Min Angle	0.0	0.0	0.0	0.0	0.0	0.0	0.0	0.0	0.0	0.0	0.0	0.0
Max Rad.	75.9	75.8	74.5	90.5	90.4	88.8	120.7	120.5	118.6	151.9	151.6	149.6
Capacity	11,200	11,400	12,100	6,600	6,700	7,000	4,900	5,000	5,200	3,200	3,200	3,400

1062050



PORTLAND OFFICE: 503.283.3111
 SEATTLE OFFICE: 206.784.1054
WWW.NESSCAMPBELL.COM

Rated Lifting Capacities in Pounds

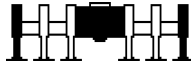

Full

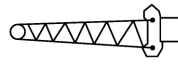

40ft Hydraulic Offset Fly



80,000 lbs



Radius (ft)	Boom Length (ft)								
	Fly Offset								
	152.4			169.0			185.5		
	2°-15°	15°-30°	30°-45°	2°-15°	15°-30°	30°-45°	2°-15°	15°-30°	30°-45°
30	31,300								
35	31,000	31,000							
40	31,000	31,000		29,200			20,200		
45	31,000	24,900	24,900	29,000	29,000		20,100	20,100	
50	30,300	24,000	20,200	29,000	24,500	24,500	20,100	20,100	
55	28,900	23,200	19,700	29,000	23,800	23,800	20,100	19,800	19,800
60	27,700	22,000	19,300	28,800	23,100	19,600	20,100	19,800	19,800
65	26,600	21,400	18,800	27,700	22,000	19,200	20,100	19,800	19,500
70	25,600	20,800	18,400	26,700	21,400	18,800	20,100	19,800	19,100
75	24,600	20,200	18,100	25,700	20,800	18,400	20,100	19,800	18,700
80	23,700	19,700	17,700	24,800	20,300	18,100	20,100	19,800	18,400
85	22,500	19,200	17,400	24,000	19,800	17,800	20,100	19,800	18,100
90	21,100	18,800	17,100	22,600	19,400	17,400	20,100	19,800	17,800
95	19,800	18,300	16,800	21,300	18,900	17,200	20,100	19,500	17,500
100	18,700	17,900	16,500	20,100	18,500	16,900	20,100	19,100	17,200
105	17,600	17,500	16,300	19,000	18,100	16,600	18,800	18,700	17,000
110	16,600	16,700	16,000	18,000	17,800	16,400	17,000	17,900	16,700
115	15,600	15,700	15,800	16,700	17,100	16,200	15,800	16,600	16,500
120	14,800	14,900	15,000	15,300	16,000	16,000	14,300	15,100	15,800
125	13,900	14,100	14,200	14,000	14,600	15,200	13,000	13,700	14,400
130	13,200	13,300	13,400	12,800	13,400	14,000	11,800	12,500	13,100
135	12,500	12,600	12,700	11,700	12,300	12,800	10,800	11,400	12,000
140	11,800	11,900	12,000	10,700	11,200	11,700	9,800	10,300	10,900
145	10,900	11,300	11,400	9,800	10,200	10,700	8,800	9,400	9,900
150	10,000	10,400	10,700	8,900	9,400	9,700	8,000	8,500	8,900
155	9,200	9,500	9,800	8,100	8,500	8,900	7,200	7,600	8,100
160	8,500	8,800	8,900	7,400	7,700	8,000	6,400	6,900	7,200
165	7,800	8,000	8,100	6,700	7,000	7,300	5,700	6,100	6,500
170	7,200	7,300	7,300	6,000	6,300	6,500	5,100	5,500	5,800
175	6,600	6,700		5,400	5,700	5,900	4,500	4,800	5,100
180				4,900	5,100	5,200	3,900	4,200	4,500
185				4,300	4,500	4,500	3,400	3,700	3,900
190				3,800	4,000		2,900	3,100	3,300
195				3,400			2,400	2,600	2,700
200							2,200	2,200	2,100
Min Angle	17.0	17.0	22.0	7.0	19.0	22.5	28.0	28.0	28.0
Max Rad. Capacity	180.0	180.0	175.0	199.9	195.0	190.0	200.0	202.0	201.0
	0	0	0	0	0	0	0	0	0

1062050



PORTLAND OFFICE: 503.283.3111
 SEATTLE OFFICE: 206.784.1054
WWW.NESSCAMPBELL.COM

Rated Lifting Capacities in Pounds

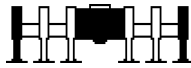

Full

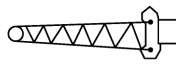

40ft Hydraulic Offset Fly



80,000 lbs



Radius (ft)	Boom Length (ft)											
	Fly Offset											
	44.3			73.5			103.8			119.4		
	2°-15°	15°-30°	30°-45°	2°-15°	15°-30°	30°-45°	2°-15°	15°-30°	30°-45°	2°-15°	15°-30°	30°-45°
10	34,700											
12	34,700	34,700		34,600								
15	34,700	34,700		34,600								
20	32,000	27,100	27,100	34,600	34,600		34,500					
25	28,800	24,900	24,900	32,900	32,900		34,500	34,500		33,900		
30	26,200	22,900	20,200	30,300	25,100	25,100	33,500	33,500		33,600	33,600	
35	24,000	20,700	19,000	28,100	23,600	20,300	31,400	25,200	25,200	32,700	25,800	25,800
40	21,400	19,400	18,000	26,200	21,700	19,500	29,500	24,000	20,400	30,900	24,700	20,700
45	19,900	18,200	17,200	24,600	20,700	18,700	27,800	23,000	19,700	29,200	23,700	20,100
50	18,600	17,300	16,400	23,100	19,700	18,000	26,300	21,500	19,100	27,700	22,800	19,500
55	17,500	16,400	15,800	21,200	18,900	17,400	25,000	20,700	18,500	26,400	21,500	19,000
60	16,500	15,700	15,300	20,100	18,100	16,900	23,800	20,000	18,000	25,200	20,700	18,500
65	15,600	15,000	14,900	19,200	17,400	16,400	22,700	19,300	17,500	24,100	20,000	18,000
70	14,900	14,600	14,600	18,300	16,800	15,900	21,200	18,600	17,100	23,100	19,400	17,600
75	14,300	14,300		17,500	16,200	15,600	20,400	18,000	16,700	21,600	18,800	17,200
80				16,800	15,700	15,300	19,600	17,500	16,400	20,800	18,300	16,900
85				16,100	15,300	15,000	18,800	17,000	16,000	20,100	17,800	16,500
90				15,500	14,900	14,900	18,200	16,600	15,700	19,400	17,300	16,200
95				15,000	14,600	14,600	17,600	16,200	15,500	18,800	16,900	15,900
100				14,600	14,500		17,000	15,800	15,300	18,200	16,500	15,700
105				9,500			16,000	15,400	15,100	17,600	16,100	15,500
110							15,100	15,100	14,900	16,800	15,800	15,300
115							14,300	14,300	14,300	16,000	15,500	15,100
120							13,500	13,500	13,500	15,200	15,100	15,000
125							12,800	12,800	12,800	14,400	14,400	14,400
130							12,200	12,200		13,800	13,700	13,700
135							8,800			13,100	13,100	13,100
140										12,500	12,500	12,500
145										12,000	12,000	
Min Angle	0.0	0.0	0.0	0.0	0.0	0.0	0.0	0.0	0.0	11.5	13.0	0.0
Max Rad.	75.9	75.8	74.5	105.1	104.9	103.2	135.3	135.1	133.1	150.0	150.0	148.6
Capacity	11,200	11,400	12,100	3,700	3,700	3,900	2,600	2,600	2,700	0	0	2,000

1062060



PORTLAND OFFICE: 503.283.3111
 SEATTLE OFFICE: 206.784.1054
WWW.NESSCAMPBELL.COM

Rated Lifting Capacities in Pounds

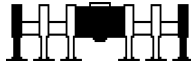

Full

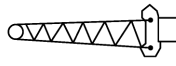

40ft Hydraulic Offset Fly



80,000 lbs



Radius (ft)	Boom Length (ft)								
	Fly Offset								
	135.4			152.0			168.5		
	2°-15°	15°-30°	30°-45°	2°-15°	15°-30°	30°-45°	2°-15°	15°-30°	30°-45°
25	34,400								
30	34,400			33,800					
35	33,900	33,900		33,500	33,500		29,200		
40	32,100	25,300	25,300	33,300	33,300		28,900	28,900	
45	30,500	24,300	20,400	31,700	24,900	24,900	28,900	28,900	
50	29,000	23,400	19,900	30,200	24,000	20,200	28,900	24,500	24,500
55	27,700	22,100	19,400	28,900	23,200	19,700	28,900	23,800	20,000
60	26,500	21,400	18,900	27,700	22,000	19,200	28,800	23,100	19,600
65	25,400	20,700	18,400	26,600	21,400	18,800	27,700	22,000	19,200
70	24,300	20,100	18,000	25,500	20,800	18,400	26,600	21,400	18,800
75	23,400	19,600	17,600	24,600	20,200	18,000	25,700	20,800	18,400
80	22,000	19,000	17,300	23,700	19,700	17,700	24,800	20,300	18,100
85	21,300	18,500	17,000	22,900	19,200	17,400	24,000	19,800	17,700
90	20,600	18,100	16,700	21,700	18,700	17,100	23,200	19,300	17,400
95	19,900	17,600	16,400	21,000	18,300	16,800	22,000	18,900	17,100
100	19,300	17,200	16,100	20,400	17,900	16,500	21,400	18,500	16,900
105	18,700	16,800	15,900	19,800	17,500	16,300	19,800	18,100	16,600
110	18,200	16,500	15,600	19,200	17,100	16,000	18,100	17,700	16,400
115	17,600	16,200	15,500	17,700	16,800	15,800	16,800	17,300	16,200
120	16,800	15,800	15,300	16,500	16,500	15,600	15,400	16,000	16,000
125	16,000	15,600	15,100	15,200	15,700	15,500	14,100	14,700	15,300
130	15,300	15,200	15,000	14,000	14,500	15,000	12,900	13,500	14,000
135	14,200	14,500	14,500	12,900	13,400	13,800	11,800	12,300	12,800
140	13,200	13,500	13,800	11,900	12,300	12,700	10,800	11,300	11,700
145	12,300	12,600	12,800	11,000	11,300	11,700	9,800	10,300	10,700
150	11,400	11,700	11,800	10,100	10,400	10,700	9,000	9,400	9,800
155	10,600	10,800	10,800	9,300	9,600	9,800	8,200	8,600	8,900
160	9,900			8,600	8,800	9,000	7,400	7,800	8,100
165				7,900	8,100	8,200	6,700	7,100	7,300
170				7,200	7,400	7,400	6,100	6,400	6,600
175				6,600	6,800		5,500	5,700	5,900
180							4,900	5,100	5,200
185							4,400	4,600	4,500
190							3,900	4,000	
Min Angle	14.0	23.5	3.5	15.5	15.0	20.0	19.0	18.0	21.5
Max Rad. Capacity	165.0	160.0	158.9	180.0	180.0	175.0	195.0	195.0	190.0
	0	0	0	0	0	0	0	0	0

1062060



PORTLAND OFFICE: 503.283.3111
 SEATTLE OFFICE: 206.784.1054
WWW.NESSCAMPBELL.COM

Rated Lifting Capacities in Pounds

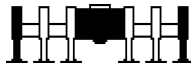

Full

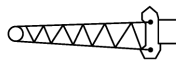

67ft Offset Fly



80,000 lbs



Radius (ft)	Boom Length (ft)											
	Fly Offset											
	44.3				73.5				103.8			
	2°	15°	30°	45°	2°	15°	30°	45°	2°	15°	30°	45°
15	30,000											
20	27,800				27,500							
25	24,600	19,800			27,500				18,200			
30	21,100	18,100			21,400				18,200			
35	19,100	16,600			21,400	18,500			18,200			
40	17,400	15,400	13,700		21,100	17,300			18,200	18,100		
45	16,000	14,300	12,800		19,500	16,200	13,700		18,200	17,700		
50	14,800	13,300	12,100		18,100	15,300	13,100		18,200	16,800		
55	13,800	12,500	11,400	10,600	16,900	14,400	12,400		18,200	15,900	13,200	
60	12,800	11,700	10,800	10,100	15,800	13,600	11,900	10,700	18,200	15,200	12,700	
65	12,000	11,100	10,300	9,700	14,900	12,900	11,400	10,300	17,500	14,500	12,200	10,800
70	11,200	10,500	9,800	9,300	14,000	12,300	10,900	10,000	16,600	13,800	11,800	10,500
75	10,600	9,900	9,300	8,900	13,200	11,700	10,500	9,700	15,700	13,200	11,400	10,200
80	10,000	9,400	8,900	8,600	12,500	11,200	10,100	9,400	14,900	12,700	11,000	9,900
85	9,400	9,000	8,600	8,400	11,900	10,700	9,800	9,100	14,200	12,200	10,600	9,700
90	8,900	8,600	8,300	8,200	11,300	10,300	9,400	8,900	13,500	11,700	10,300	9,400
95	8,500	8,200	8,000		10,800	9,900	9,100	8,700	12,900	11,300	10,000	9,200
100	8,100	7,900			10,300	9,500	8,900	8,500	12,400	10,900	9,700	9,000
105					9,800	9,100	8,600	8,300	11,800	10,500	9,500	8,900
110					9,400	8,800	8,400	8,200	11,400	10,200	9,200	8,700
115					9,000	8,500	8,200	8,200	10,900	9,800	9,000	8,500
120					8,700	8,300	8,000		10,500	9,500	8,800	8,400
125					8,300	8,100	8,000		10,100	9,300	8,600	8,300
130									9,800	9,000	8,400	8,200
135									9,400	8,800	8,300	8,200
140									9,100	8,500	8,200	8,200
145									8,800	8,300	8,000	
150									8,500	8,100	8,000	
155									8,300	8,000		
Min Angle	0.0	0.0	0.0	0.0	14.0	18.5	0.0	0.0	15.5	18.5	27.0	11.5
Max Rad.	102.9	102.7	100.7	96.8	130.0	130.0	128.9	123.9	160.0	160.0	155.0	146.4
Capacity	6,200	6,400	7,000	8,200	0	0	2,000	2,300	0	0	0	0

1061070



PORTLAND OFFICE: 503.283.3111
 SEATTLE OFFICE: 206.784.1054
WWW.NESSCAMPBELL.COM

Rated Lifting Capacities in Pounds

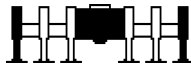

Full

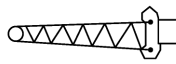

67ft Offset Fly



80,000 lbs



Radius (ft)	Boom Length (ft)											
	Fly Offset											
	134.9				167.1				183.6			
	2°	15°	30°	45°	2°	15°	30°	45°	2°	15°	30°	45°
30	15,900											
35	15,900				13,300							
40	15,900				13,300				12,400			
45	15,900	15,800			13,300				12,400			
50	15,900	15,800			13,300				12,400			
55	15,900	15,800			13,300	13,300			12,400			
60	15,900	15,800	13,300		13,300	13,300			12,400	12,300		
65	15,900	15,800	12,900		13,300	13,300			12,400	12,300		
70	15,900	15,100	12,400		13,300	13,300	13,000		12,400	12,300		
75	15,900	14,500	12,100	10,500	13,300	13,300	12,600		12,400	12,300	12,300	
80	15,900	14,000	11,700	10,300	13,300	13,300	12,300	10,600	12,400	12,300	12,300	
85	15,900	13,500	11,400	10,100	13,300	13,300	12,000	10,400	12,400	12,300	12,200	
90	15,700	13,000	11,100	9,800	13,300	13,300	11,600	10,200	12,400	12,300	11,900	10,300
95	15,000	12,600	10,800	9,600	13,300	13,300	11,400	10,000	12,400	12,300	11,600	10,100
100	14,400	12,100	10,500	9,500	13,300	13,300	11,100	9,800	12,400	12,300	11,400	10,000
105	13,800	11,700	10,200	9,300	13,300	12,900	10,800	9,600	12,400	12,300	11,100	9,800
110	13,300	11,400	10,000	9,100	13,300	12,500	10,600	9,500	12,400	12,300	10,900	9,600
115	12,800	11,000	9,700	9,000	13,300	12,100	10,400	9,300	12,400	12,300	10,600	9,500
120	12,300	10,700	9,500	8,800	13,300	11,800	10,100	9,200	12,400	12,300	10,400	9,300
125	11,900	10,400	9,300	8,700	13,000	11,500	9,900	9,000	12,400	12,000	10,200	9,200
130	11,400	10,100	9,100	8,600	12,300	11,200	9,700	8,900	12,400	11,600	10,000	9,100
135	11,100	9,900	8,900	8,500	11,600	10,900	9,500	8,800	12,400	11,400	9,800	9,000
140	10,700	9,600	8,800	8,400	11,000	10,600	9,400	8,700	11,800	11,100	9,600	8,900
145	10,300	9,400	8,600	8,300	10,400	10,300	9,200	8,600	10,900	10,800	9,500	8,700
150	9,800	9,100	8,500	8,200	9,800	10,000	9,000	8,500	10,000	10,600	9,300	8,600
155	9,300	8,900	8,300	8,200	9,300	9,500	8,900	8,400	9,200	10,000	9,200	8,600
160	8,900	8,700	8,200	8,100	8,800	9,000	8,800	8,300	8,400	9,200	9,000	8,500
165	8,400	8,500	8,100	8,100	8,300	8,500	8,600	8,300	7,700	8,500	8,900	8,400
170	8,000	8,100	8,000		7,800	8,100	8,300	8,200	7,100	7,800	8,400	8,300
175	7,700	7,700	7,800		7,400	7,600	7,800	7,900	6,500	7,100	7,700	8,000
180	7,300	7,400	7,400		6,900	7,200	7,400	7,500	5,900	6,500	7,000	7,300
185	7,000	7,000			6,400	6,800	7,000	7,000	5,300	5,900	6,400	6,600
190					5,900	6,300	6,600	6,600	4,800	5,300	5,800	6,000
195					5,400	5,700	6,000		4,300	4,800	5,200	5,400
200					4,900	5,200	5,500		3,900	4,300	4,700	4,800
205					4,500	4,800	4,900		3,400	3,800	4,100	4,200
210					4,100	4,300	4,400		3,000	3,400	3,700	
215					3,700	3,900			2,600	3,000	3,200	
220					3,400				2,300	2,600	2,700	
225										2,200	2,300	
Min Angle	17.5	20.0	27.0	14.5	10.0	21.5	13.5	14.0	28.5	28.5	29.0	27.0
Max Rad. Capacity	190.0	190.0	185.0	177.6	225.0	220.0	218.7	209.7	223.8	227.5	228.0	225.7
	0	0	0	0	0	0	0	0	0	0	0	0

1061070



PORTLAND OFFICE: 503.283.3111
 SEATTLE OFFICE: 206.784.1054
WWW.NESSCAMPBELL.COM

Rated Lifting Capacities in Pounds

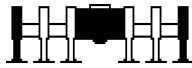

Full

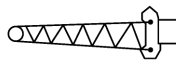

67ft Offset Fly



80,000 lbs



Radius (ft)	Boom Length (ft)			
	Fly Offset			
	200.1			
	2°	15°	30°	45°
45	10,800			
50	10,800			
55	10,800			
60	10,800			
65	10,800	10,800		
70	10,800	10,800		
75	10,800	10,800		
80	10,800	10,800	10,700	
85	10,800	10,800	10,700	
90	10,800	10,800	10,700	
95	10,800	10,800	10,700	10,300
100	10,800	10,800	10,700	10,100
105	10,800	10,800	10,700	9,900
110	10,800	10,800	10,700	9,800
115	10,800	10,800	10,700	9,600
120	10,800	10,800	10,700	9,500
125	10,800	10,800	10,500	9,400
130	10,800	10,800	10,300	9,200
135	10,800	10,800	10,100	9,100
140	10,800	10,800	9,900	9,000
145	10,000	10,800	9,700	8,900
150	9,100	10,000	9,600	8,800
155	8,300	9,200	9,400	8,700
160	7,500	8,400	9,200	8,600
165	6,800	7,600	8,400	8,500
170	6,200	6,900	7,700	8,100
175	5,500	6,300	6,900	7,400
180	5,000	5,600	6,300	6,700
185	4,400	5,100	5,600	6,000
190	3,900	4,500	5,000	5,400
195	3,400	4,000	4,500	4,700
200	3,000	3,500	3,900	4,200
205	2,500	3,000	3,400	3,600
210	2,100	2,600	2,900	3,100
215		2,100	2,500	2,600
Min Angle	41.5	42.5	42.5	42.0
Max Rad. Capacity	211.3	216.3	220.0	221.0
	0	0	0	0

1061070



PORTLAND OFFICE: 503.283.3111
 SEATTLE OFFICE: 206.784.1054
WWW.NESSCAMPBELL.COM

Rated Lifting Capacities in Pounds

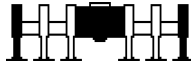

Full

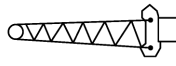

67ft Offset Fly



80,000 lbs



Radius (ft)	Boom Length (ft)											
	Fly Offset											
	44.3				58.9				89.1			
	2°	15°	30°	45°	2°	15°	30°	45°	2°	15°	30°	45°
15	30,000											
20	27,800				30,000				28,400			
25	24,600	19,800			26,900				28,400			
30	21,100	18,100			24,100	19,100			28,100			
35	19,100	16,600			21,100	17,700			25,600	19,300		
40	17,400	15,400	13,700		19,300	16,400			23,500	18,100		
45	16,000	14,300	12,800		17,800	15,300	13,300		21,100	17,000		
50	14,800	13,300	12,100		16,500	14,400	12,600		19,700	16,100	13,400	
55	13,800	12,500	11,400	10,600	15,400	13,500	12,000	10,900	18,400	15,200	12,900	
60	12,800	11,700	10,800	10,100	14,400	12,700	11,400	10,400	17,300	14,500	12,300	10,900
65	12,000	11,100	10,300	9,700	13,500	12,100	10,900	10,000	16,300	13,800	11,800	10,600
70	11,200	10,500	9,800	9,300	12,700	11,400	10,400	9,700	15,300	13,100	11,400	10,300
75	10,600	9,900	9,300	8,900	11,900	10,900	10,000	9,300	14,500	12,500	11,000	10,000
80	10,000	9,400	8,900	8,600	11,300	10,400	9,600	9,000	13,800	12,000	10,600	9,700
85	9,400	9,000	8,600	8,400	10,700	9,900	9,200	8,800	13,100	11,500	10,200	9,400
90	8,900	8,600	8,300	8,200	10,200	9,500	8,900	8,600	12,500	11,100	9,900	9,200
95	8,500	8,200	8,000		9,700	9,100	8,600	8,400	11,900	10,600	9,600	9,000
100	8,100	7,900			9,200	8,700	8,300	8,200	11,400	10,200	9,300	8,800
105					8,800	8,400	8,100		10,900	9,900	9,100	8,600
110					8,400	8,100	8,000		10,400	9,500	8,800	8,500
115					8,100	7,900			10,000	9,200	8,600	8,300
120									9,600	8,900	8,400	8,200
125									9,300	8,700	8,300	8,200
130									8,900	8,400	8,100	
135									8,600	8,200	8,000	
140									8,300	8,000	8,000	
145									8,100	7,900		
Min Angle	0.0	0.0	0.0	0.0	0.0	0.0	0.0	0.0	0.0	0.0	0.0	0.0
Max Rad.	102.9	102.7	100.7	96.8	117.5	117.1	114.7	110.2	147.7	147.1	144.1	138.7
Capacity	6,200	6,400	7,000	8,200	3,600	3,700	4,100	4,700	2,600	2,600	2,900	3,400

1061080



PORTLAND OFFICE: 503.283.3111
 SEATTLE OFFICE: 206.784.1054
WWW.NESSCAMPBELL.COM

Rated Lifting Capacities in Pounds

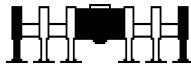

Full

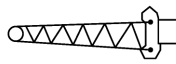

67ft Offset Fly



80,000 lbs



Radius (ft)	Boom Length (ft)											
	Fly Offset											
	120.3				152.4				169.0			
	2°	15°	30°	45°	2°	15°	30°	45°	2°	15°	30°	45°
25	19,500											
30	19,500											
35	19,500				16,600				15,500			
40	19,500				16,600				15,500			
45	19,500	18,400			16,600				15,500			
50	19,500	17,500			16,600	16,500			15,500			
55	19,500	16,600	13,500		16,600	16,500			15,500	15,500		
60	19,500	15,900	13,000		16,600	16,500			15,500	15,500		
65	18,900	15,200	12,600		16,600	16,400	13,100		15,500	15,500		
70	17,900	14,500	12,200	10,700	16,600	15,800	12,700		15,500	15,500	13,000	
75	17,000	14,000	11,800	10,400	16,600	15,200	12,400	10,700	15,500	15,500	12,600	
80	16,100	13,400	11,400	10,100	16,600	14,600	12,000	10,500	15,500	15,200	12,300	
85	15,400	12,900	11,100	9,900	16,600	14,100	11,700	10,200	15,500	14,700	12,000	10,400
90	14,700	12,400	10,700	9,700	16,600	13,600	11,400	10,000	15,500	14,200	11,700	10,200
95	14,000	12,000	10,400	9,500	16,100	13,200	11,100	9,800	15,500	13,700	11,400	10,000
100	13,400	11,600	10,200	9,300	15,400	12,800	10,800	9,700	15,500	13,300	11,100	9,800
105	12,900	11,200	9,900	9,100	14,800	12,400	10,600	9,500	15,500	12,900	10,900	9,700
110	12,400	10,800	9,600	8,900	14,300	12,000	10,300	9,300	15,200	12,500	10,600	9,500
115	11,900	10,500	9,400	8,800	13,700	11,600	10,100	9,200	14,600	12,200	10,400	9,300
120	11,500	10,200	9,200	8,600	13,300	11,300	9,900	9,000	14,100	11,800	10,200	9,200
125	11,100	9,900	9,000	8,500	12,800	11,000	9,700	8,900	13,600	11,500	10,000	9,100
130	10,700	9,600	8,800	8,400	12,400	10,700	9,500	8,800	13,200	11,200	9,800	8,900
135	10,300	9,300	8,600	8,300	12,000	10,400	9,300	8,700	12,600	10,900	9,600	8,800
140	10,000	9,100	8,500	8,200	11,300	10,200	9,100	8,500	11,600	10,700	9,400	8,700
145	9,600	8,900	8,300	8,200	10,700	9,900	8,900	8,500	10,600	10,400	9,200	8,600
150	9,300	8,700	8,200	8,200	10,200	9,700	8,800	8,400	9,700	10,200	9,100	8,500
155	9,100	8,500	8,100		9,600	9,400	8,600	8,300	8,900	9,700	8,900	8,400
160	8,800	8,300	8,000		9,100	9,200	8,500	8,200	8,200	8,900	8,800	8,300
165	8,500	8,100	8,000		8,600	8,800	8,400	8,200	7,500	8,200	8,700	8,300
170	8,300	8,000			7,900	8,400	8,300	8,100	6,800	7,500	8,000	8,200
175					7,300	7,800	8,100	8,100	6,200	6,800	7,300	7,600
180					6,700	7,100	7,500	7,500	5,600	6,200	6,600	6,900
185					6,200	6,600	6,800		5,100	5,600	6,000	6,200
190					5,700	6,000	6,200		4,600	5,000	5,400	5,500
195					5,200	5,500	5,600		4,100	4,500	4,800	
200					4,700	5,000			3,600	4,000	4,300	
205					4,300	4,500			3,200	3,500	3,700	
210									2,800	3,100	3,200	
215									2,400	2,600		
220									2,100	2,200		
Min Angle	18.0	20.5	28.0	3.5	11.5	7.5	11.0	29.5	18.5	19.0	21.5	20.5
Max Rad.	175.0	175.0	170.0	163.0	210.0	209.5	204.1	195.0	221.3	222.5	220.0	211.7
Capacity	0	0	0	0	0	0	0	0	0	0	0	0

1061080



PORTLAND OFFICE: 503.283.3111
 SEATTLE OFFICE: 206.784.1054
WWW.NESSCAMPBELL.COM

Rated Lifting Capacities in Pounds

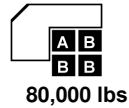
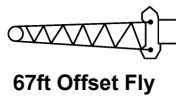
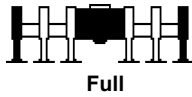

Radius (ft)	Boom Length (ft)			
	Fly Offset			
	185.5			
	2°	15°	30°	45°
40	13,500			
45	13,500			
50	13,500			
55	13,500			
60	13,500	13,500		
65	13,500	13,500		
70	13,500	13,500		
75	13,500	13,500	12,900	
80	13,500	13,500	12,500	
85	13,500	13,500	12,200	
90	13,500	13,500	11,900	10,300
95	13,500	13,500	11,700	10,100
100	13,500	13,500	11,400	10,000
105	13,500	13,400	11,100	9,800
110	13,500	13,000	10,900	9,600
115	13,500	12,700	10,700	9,500
120	13,500	12,300	10,500	9,400
125	13,500	12,000	10,200	9,200
130	12,700	11,700	10,000	9,100
135	11,600	11,400	9,900	9,000
140	10,600	11,100	9,700	8,900
145	9,700	10,700	9,500	8,800
150	8,800	9,700	9,400	8,700
155	8,000	8,900	9,200	8,600
160	7,200	8,100	8,900	8,500
165	6,500	7,300	8,100	8,400
170	5,900	6,600	7,300	7,700
175	5,200	5,900	6,600	7,000
180	4,700	5,300	5,900	6,200
185	4,100	4,700	5,300	5,600
190	3,600	4,200	4,700	4,900
195	3,100	3,700	4,100	4,300
200	2,700	3,200	3,600	3,700
205	2,200	2,700	3,000	3,100
210		2,200	2,500	
215			2,100	
Min Angle	37.5	38.0	38.0	38.0
Max Rad.	207.5	212.5	216.0	215.0
Capacity	0	0	0	0

1061080



PORTLAND OFFICE: 503.283.3111
 SEATTLE OFFICE: 206.784.1054
WWW.NESSCAMPBELL.COM

Rated Lifting Capacities in Pounds

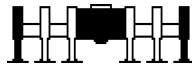

Full

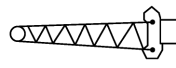

67ft Offset Fly



80,000 lbs



Radius (ft)	Boom Length (ft)											
	Fly Offset											
	44.3				73.5				103.8			
	2°	15°	30°	45°	2°	15°	30°	45°	2°	15°	30°	45°
15	30,000											
20	27,800				27,500							
25	24,600	19,800			27,500							
30	21,100	18,100			21,400				18,200			
35	19,100	16,600			21,400	18,500			18,200			
40	17,400	15,400	13,700		21,100	17,300			18,200			
45	16,000	14,300	12,800		19,500	16,200	13,700		18,200	17,700		
50	14,800	13,300	12,100		18,100	15,300	13,100		18,200	16,800		
55	13,800	12,500	11,400	10,600	16,900	14,400	12,400		18,200	15,900	13,200	
60	12,800	11,700	10,800	10,100	15,800	13,600	11,900	10,700	18,200	15,200	12,700	
65	12,000	11,100	10,300	9,700	14,900	12,900	11,400	10,300	17,500	14,500	12,200	10,800
70	11,200	10,500	9,800	9,300	14,000	12,300	10,900	10,000	16,600	13,800	11,800	10,500
75	10,600	9,900	9,300	8,900	13,200	11,700	10,500	9,700	15,700	13,200	11,400	10,200
80	10,000	9,400	8,900	8,600	12,500	11,200	10,100	9,400	14,900	12,700	11,000	9,900
85	9,400	9,000	8,600	8,400	11,900	10,700	9,800	9,100	14,200	12,200	10,600	9,700
90	8,900	8,600	8,300	8,200	11,300	10,300	9,400	8,900	13,500	11,700	10,300	9,400
95	8,500	8,200	8,000		10,800	9,900	9,100	8,700	12,900	11,300	10,000	9,200
100	8,100	7,900			10,300	9,500	8,900	8,500	12,400	10,900	9,700	9,000
105					9,800	9,100	8,600	8,300	11,800	10,500	9,500	8,900
110					9,400	8,800	8,400	8,200	11,400	10,200	9,200	8,700
115					9,000	8,500	8,200	8,200	10,900	9,800	9,000	8,500
120					8,700	8,300	8,000		10,500	9,500	8,800	8,400
125					8,300	8,100	8,000		10,100	9,300	8,600	8,300
130									9,800	9,000	8,400	8,200
135									9,400	8,800	8,300	8,200
140									9,100	8,500	8,200	8,200
145									8,800	8,300	8,000	
150									8,500	8,100	8,000	
155									8,300	8,000		
Min Angle	0.0	0.0	0.0	0.0	14.0	18.5	0.0	0.0	15.5	18.5	27.0	11.5
Max Rad.	102.9	102.7	100.7	96.8	130.0	130.0	128.9	123.9	160.0	160.0	155.0	146.4
Capacity	6,200	6,400	7,000	8,200	0	0	2,000	2,300	0	0	0	0

1061090



PORTLAND OFFICE: 503.283.3111
 SEATTLE OFFICE: 206.784.1054
WWW.NESSCAMPBELL.COM

Rated Lifting Capacities in Pounds

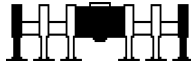

Full

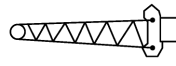

67ft Offset Fly



80,000 lbs



Radius (ft)	Boom Length (ft)											
	Fly Offset											
	119.4				135.4				152.0			
	2°	15°	30°	45°	2°	15°	30°	45°	2°	15°	30°	45°
30	17,800											
35	17,800				18,100				17,400			
40	17,800				18,100				17,400			
45	17,800				18,100	18,000			17,400			
50	17,800	17,400			18,100	18,000			17,400	17,300		
55	17,800	16,600			18,100	17,200			17,400	17,300		
60	17,800	15,800	13,000		18,100	16,500	13,300		17,400	17,100		
65	17,800	15,200	12,600		18,100	15,800	12,900		17,400	16,400	13,100	
70	17,800	14,500	12,100	10,600	18,100	15,100	12,500		17,400	15,700	12,700	
75	16,900	13,900	11,700	10,400	18,000	14,500	12,100	10,500	17,400	15,200	12,400	10,700
80	16,100	13,400	11,400	10,100	17,200	14,000	11,700	10,300	17,400	14,600	12,000	10,500
85	15,300	12,900	11,000	9,900	16,400	13,500	11,400	10,100	17,400	14,100	11,700	10,200
90	14,600	12,400	10,700	9,700	15,700	13,000	11,100	9,900	16,700	13,600	11,400	10,000
95	14,000	12,000	10,400	9,400	15,000	12,600	10,800	9,600	16,000	13,200	11,100	9,800
100	13,400	11,500	10,100	9,300	14,400	12,200	10,500	9,500	15,400	12,700	10,800	9,600
105	12,800	11,200	9,900	9,100	13,800	11,800	10,200	9,300	14,800	12,400	10,600	9,500
110	12,300	10,800	9,600	8,900	13,300	11,400	10,000	9,100	14,200	12,000	10,300	9,300
115	11,900	10,500	9,400	8,800	12,800	11,100	9,700	9,000	13,700	11,600	10,100	9,200
120	11,400	10,200	9,200	8,600	12,300	10,700	9,500	8,800	13,200	11,300	9,900	9,000
125	11,000	9,900	9,000	8,500	11,900	10,400	9,300	8,700	12,800	11,000	9,600	8,900
130	10,600	9,600	8,800	8,400	11,500	10,100	9,100	8,600	12,300	10,700	9,500	8,800
135	10,300	9,300	8,600	8,300	11,100	9,900	8,900	8,500	11,900	10,400	9,300	8,700
140	9,900	9,100	8,500	8,200	10,700	9,600	8,800	8,400	11,600	10,100	9,100	8,500
145	9,600	8,800	8,300	8,200	10,400	9,400	8,600	8,300	11,200	9,900	8,900	8,500
150	9,300	8,600	8,200	8,200	10,100	9,100	8,500	8,200	10,900	9,700	8,800	8,400
155	9,000	8,400	8,100		9,800	8,900	8,300	8,200	10,100	9,400	8,600	8,300
160	8,700	8,300	8,000		9,500	8,700	8,200	8,100	9,300	9,200	8,500	8,200
165	8,500	8,100	8,000		9,200	8,500	8,100	8,100	8,600	9,000	8,400	8,200
170	8,300	8,000			9,000	8,400	8,000		8,000	8,500	8,300	8,100
175					8,600	8,200	8,000		7,400	7,800	8,200	8,100
180					8,100	8,100	8,000		6,800	7,200	7,500	
185					7,500	7,700			6,200	6,600	6,900	
190									5,700	6,000	6,300	
195									5,200	5,500	5,600	
200									4,800	5,000		
205									4,400			
Min Angle	16.5	19.5	27.0	12.5	17.5	20.0	26.5	12.5	8.5	20.5	9.5	10.0
Max Rad. Capacity	175.0	175.0	170.0	162.0	190.0	190.0	185.0	178.1	210.0	205.0	203.6	194.6
	0	0	0	0	0	0	0	0	0	0	0	0

1061090



PORTLAND OFFICE: 503.283.3111
 SEATTLE OFFICE: 206.784.1054
WWW.NESSCAMPBELL.COM

Rated Lifting Capacities in Pounds

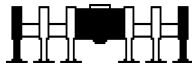

Full

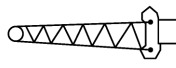

67ft Offset Fly



80,000 lbs



Radius (ft)	Boom Length (ft)			
	Fly Offset			
	168.5			
	2°	15°	30°	45°
35	15,300			
40	15,300			
45	15,300			
50	15,300			
55	15,300	15,200		
60	15,300	15,200		
65	15,300	15,200		
70	15,300	15,200	13,000	
75	15,300	15,200	12,600	
80	15,300	15,200	12,300	
85	15,300	14,600	12,000	10,400
90	15,300	14,200	11,700	10,200
95	15,300	13,700	11,400	10,000
100	15,300	13,300	11,100	9,800
105	15,300	12,900	10,900	9,600
110	15,200	12,500	10,600	9,500
115	14,600	12,200	10,400	9,300
120	14,100	11,800	10,200	9,200
125	13,600	11,500	10,000	9,100
130	13,200	11,200	9,800	8,900
135	12,600	10,900	9,600	8,800
140	11,600	10,600	9,400	8,700
145	10,700	10,400	9,200	8,600
150	9,800	10,100	9,100	8,500
155	9,000	9,800	8,900	8,400
160	8,200	9,000	8,800	8,300
165	7,500	8,200	8,700	8,300
170	6,900	7,500	8,100	8,200
175	6,200	6,800	7,400	7,600
180	5,700	6,200	6,700	6,900
185	5,100	5,600	6,000	6,200
190	4,600	5,100	5,400	5,500
195	4,100	4,500	4,900	
200	3,700	4,000	4,300	
205	3,300	3,600	3,800	
210	2,800	3,100	3,300	
215	2,500	2,700		
220	2,100	2,300		
Min Angle	17.5	16.0	20.0	22.0
Max Rad.	221.7	223.8	220.0	211.2
Capacity	0	0	0	0

1061090



PORTLAND OFFICE: 503.283.3111
 SEATTLE OFFICE: 206.784.1054
WWW.NESSCAMPBELL.COM

Rated Lifting Capacities in Pounds

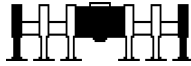

Full

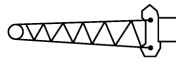

67ft Hydraulic Offset Fly



80,000 lbs



Radius (ft)	Boom Length (ft)											
	Fly Offset											
	44.3			73.5			103.8			134.9		
	2°-15°	15°-30°	30°-45°	2°-15°	15°-30°	30°-45°	2°-15°	15°-30°	30°-45°	2°-15°	15°-30°	30°-45°
15	30,000											
20	27,800			27,500								
25	19,800	19,800		27,500			18,200					
30	18,100	18,100		19,900	19,900		18,200			15,900		
35	16,600	16,600		18,500	18,500		18,200			15,900		
40	15,400	13,700	13,700	17,300	17,300		18,100	18,100		15,900		
45	14,300	12,800	12,800	16,200	13,700	13,700	17,700	17,700		15,800	15,800	
50	13,300	12,100	11,100	15,300	13,100	13,100	16,800	13,800	13,800	15,800	15,800	
55	12,500	11,400	10,600	14,400	12,400	11,100	15,900	13,200	13,200	15,800	15,800	
60	11,700	10,800	10,100	13,600	11,900	10,700	15,200	12,700	12,700	15,800	13,300	13,300
65	11,100	10,300	9,700	12,900	11,400	10,300	14,500	12,200	10,800	15,800	12,900	12,900
70	10,500	9,800	9,300	12,300	10,900	10,000	13,800	11,800	10,500	15,100	12,400	10,800
75	9,900	9,300	8,900	11,700	10,500	9,700	13,200	11,400	10,200	14,500	12,100	10,500
80	9,400	8,900	8,600	11,200	10,100	9,400	12,700	11,000	9,900	14,000	11,700	10,300
85	9,000	8,600	8,400	10,700	9,800	9,100	12,200	10,600	9,700	13,500	11,400	10,100
90	8,600	8,300	8,200	10,300	9,400	8,900	11,700	10,300	9,400	13,000	11,100	9,800
95	8,200	8,000	8,000	9,900	9,100	8,700	11,300	10,000	9,200	12,600	10,800	9,600
100	7,900	7,900		9,500	8,900	8,500	10,900	9,700	9,000	12,100	10,500	9,500
105				9,100	8,600	8,300	10,500	9,500	8,900	11,700	10,200	9,300
110				8,800	8,400	8,200	10,200	9,200	8,700	11,400	10,000	9,100
115				8,500	8,200	8,200	9,800	9,000	8,500	11,000	9,700	9,000
120				8,300	8,000	8,000	9,500	8,800	8,400	10,700	9,500	8,800
125				8,100	8,000	8,000	9,300	8,600	8,300	10,400	9,300	8,700
130							9,000	8,400	8,200	10,100	9,100	8,600
135							8,800	8,300	8,200	9,900	8,900	8,500
140							8,500	8,200	8,200	9,600	8,800	8,400
145							8,300	8,000	8,000	9,400	8,600	8,300
150							8,100	8,000		9,100	8,500	8,200
155							8,000			8,900	8,300	8,200
160										8,700	8,200	8,100
165										8,400	8,100	8,100
170										8,000	8,000	8,000
175										7,700	7,700	7,800
180										7,300	7,400	
185										7,000		
Min Angle	0.0	0.0	0.0	14.0	18.5	0.0	15.5	27.0	11.5	17.5	27.0	14.5
Max Rad.	102.9	102.7	100.7	130.0	130.0	128.9	160.0	155.0	146.4	190.0	185.0	177.6
Capacity	6,200	6,400	7,000	0	0	2,000	0	0	0	0	0	0

1062070



PORTLAND OFFICE: 503.283.3111
 SEATTLE OFFICE: 206.784.1054
WWW.NESSCAMPBELL.COM

Rated Lifting Capacities in Pounds

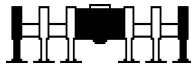

Full

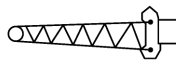

67ft Hydraulic Offset Fly



80,000 lbs



Radius (ft)	Boom Length (ft)								
	Fly Offset								
	167.1			183.6			200.1		
	2°-15°	15°-30°	30°-45°	2°-15°	15°-30°	30°-45°	2°-15°	15°-30°	30°-45°
35	13,300								
40	13,300			12,400					
45	13,300			12,400			10,800		
50	13,200	13,200		12,400			10,800		
55	13,200	13,200		12,300	12,300		10,800		
60	13,200	13,200		12,300	12,300		10,800	10,800	
65	13,200	13,200	13,200	12,300	12,300		10,800	10,800	
70	13,200	13,000	13,000	12,300	12,200	12,200	10,800	10,800	
75	13,200	12,600	12,600	12,300	12,200	12,200	10,800	10,700	10,700
80	13,200	12,300	10,600	12,300	12,200	12,200	10,800	10,700	10,700
85	13,200	12,000	10,400	12,300	12,200	10,500	10,800	10,700	10,700
90	13,200	11,600	10,200	12,300	11,900	10,300	10,800	10,700	10,400
95	13,200	11,400	10,000	12,300	11,600	10,100	10,800	10,700	10,300
100	13,200	11,100	9,800	12,300	11,400	10,000	10,800	10,700	10,100
105	12,900	10,800	9,600	12,300	11,100	9,800	10,800	10,700	9,900
110	12,500	10,600	9,500	12,300	10,900	9,600	10,800	10,700	9,800
115	12,100	10,400	9,300	12,300	10,600	9,500	10,800	10,700	9,600
120	11,800	10,100	9,200	12,300	10,400	9,300	10,800	10,700	9,500
125	11,500	9,900	9,000	12,000	10,200	9,200	10,800	10,500	9,400
130	11,200	9,700	8,900	11,600	10,000	9,100	10,800	10,300	9,200
135	10,900	9,500	8,800	11,400	9,800	9,000	10,800	10,100	9,100
140	10,600	9,400	8,700	11,100	9,600	8,900	10,800	9,900	9,000
145	10,300	9,200	8,600	10,800	9,500	8,700	10,000	9,700	8,900
150	9,800	9,000	8,500	10,000	9,300	8,600	9,100	9,600	8,800
155	9,300	8,900	8,400	9,200	9,200	8,600	8,300	9,200	8,700
160	8,800	8,800	8,300	8,400	9,000	8,500	7,500	8,400	8,600
165	8,300	8,500	8,300	7,700	8,500	8,400	6,800	7,600	8,400
170	7,800	8,100	8,200	7,100	7,800	8,300	6,200	6,900	7,700
175	7,400	7,600	7,800	6,500	7,100	7,700	5,500	6,300	6,900
180	6,900	7,200	7,400	5,900	6,500	7,000	5,000	5,600	6,300
185	6,400	6,800	7,000	5,300	5,900	6,400	4,400	5,100	5,600
190	5,900	6,300	6,600	4,800	5,300	5,800	3,900	4,500	5,000
195	5,400	5,700	6,000	4,300	4,800	5,200	3,400	4,000	4,500
200	4,900	5,200	5,400	3,900	4,300	4,700	3,000	3,500	3,900
205	4,500	4,800	4,800	3,400	3,800	4,100	2,500	3,000	3,400
210	4,100	4,300		3,000	3,400	3,700	2,100	2,600	2,900
215	3,700	3,900		2,600	3,000	3,100		2,100	2,500
220				2,300	2,600	2,600			
225					2,200	2,100			
Min Angle	21.5	13.5	14.0	28.5	28.5	27.0	41.5	42.5	42.5
Max Rad. Capacity	220.0	218.7	209.7	223.8	227.5	225.7	211.3	216.3	220.0
	0	0	0	0	0	0	0	0	0

1062070



PORTLAND OFFICE: 503.283.3111
 SEATTLE OFFICE: 206.784.1054
WWW.NESSCAMPBELL.COM

Rated Lifting Capacities in Pounds

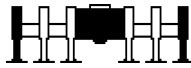

Full

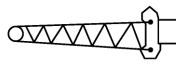

67ft Hydraulic Offset Fly



80,000 lbs



Boom Length (ft)												
Fly Offset												
Radius (ft)	44.3			58.9			89.1			120.3		
	2°-15°	15°-30°	30°-45°	2°-15°	15°-30°	30°-45°	2°-15°	15°-30°	30°-45°	2°-15°	15°-30°	30°-45°
15	30,000											
20	27,800			30,300			28,400					
25	19,800	19,800		26,900			28,400			19,500		
30	18,100	18,100		19,100	19,100		28,100			19,500		
35	16,600	16,600		17,700	17,700		19,300	19,300		19,500		
40	15,400	13,700	13,700	16,400	14,100	14,100	18,100	18,100		19,400	19,400	
45	14,300	12,800	12,800	15,300	13,300	13,300	17,000	14,100	14,100	18,400	18,400	
50	13,300	12,100	11,100	14,400	12,600	12,600	16,100	13,400	13,400	17,500	17,500	
55	12,500	11,400	10,600	13,500	12,000	10,900	15,200	12,900	12,900	16,600	13,500	13,500
60	11,700	10,800	10,100	12,700	11,400	10,400	14,500	12,300	10,900	15,900	13,000	13,000
65	11,100	10,300	9,700	12,100	10,900	10,000	13,800	11,800	10,600	15,200	12,600	10,900
70	10,500	9,800	9,300	11,400	10,400	9,700	13,100	11,400	10,300	14,500	12,200	10,700
75	9,900	9,300	8,900	10,900	10,000	9,300	12,500	11,000	10,000	14,000	11,800	10,400
80	9,400	8,900	8,600	10,400	9,600	9,000	12,000	10,600	9,700	13,400	11,400	10,100
85	9,000	8,600	8,400	9,900	9,200	8,800	11,500	10,200	9,400	12,900	11,100	9,900
90	8,600	8,300	8,200	9,500	8,900	8,600	11,100	9,900	9,200	12,400	10,700	9,700
95	8,200	8,000	8,000	9,100	8,600	8,400	10,600	9,600	9,000	12,000	10,400	9,500
100	7,900	7,900		8,700	8,300	8,200	10,200	9,300	8,800	11,600	10,200	9,300
105				8,400	8,100	8,100	9,900	9,100	8,600	11,200	9,900	9,100
110				8,100	8,000	8,000	9,500	8,800	8,500	10,800	9,600	8,900
115				7,900	7,900		9,200	8,600	8,300	10,500	9,400	8,800
120							8,900	8,400	8,200	10,200	9,200	8,600
125							8,700	8,300	8,200	9,900	9,000	8,500
130							8,400	8,100	8,100	9,600	8,800	8,400
135							8,200	8,000	8,000	9,300	8,600	8,300
140							8,000	8,000	8,000	9,100	8,500	8,200
145							7,900	7,900		8,900	8,300	8,200
150										8,700	8,200	8,200
155										8,500	8,100	8,100
160										8,300	8,000	8,000
165										8,100	8,000	
170										8,000		
Min Angle	0.0	0.0	0.0	0.0	0.0	0.0	0.0	0.0	0.0	18.0	28.0	3.5
Max Rad.	102.9	102.7	100.7	117.5	117.1	114.7	147.7	147.1	144.1	175.0	170.0	163.0
Capacity	6,200	6,400	7,000	3,600	3,700	4,100	2,600	2,600	2,900	0	0	0

1062080



PORTLAND OFFICE: 503.283.3111
 SEATTLE OFFICE: 206.784.1054
WWW.NESSCAMPBELL.COM

Rated Lifting Capacities in Pounds

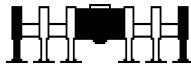

Full

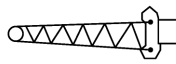

67ft Hydraulic Offset Fly



80,000 lbs



Radius (ft)	Boom Length (ft)								
	Fly Offset								
	152.4			169.0			185.5		
	2°-15°	15°-30°	30°-45°	2°-15°	15°-30°	30°-45°	2°-15°	15°-30°	30°-45°
35	16,600			15,500					
40	16,600			15,500			13,500		
45	16,600			15,500			13,500		
50	16,500	16,500		15,400	15,400		13,500		
55	16,500	16,500		15,400	15,400		13,500	13,500	
60	16,500	16,500		15,400	15,400		13,500	13,500	
65	16,400	13,100	13,100	15,400	13,400	13,400	13,500	13,500	
70	15,800	12,700	12,700	15,400	13,000	13,000	13,500	13,200	13,200
75	15,200	12,400	10,700	15,400	12,600	12,600	13,500	12,900	12,900
80	14,600	12,000	10,500	15,200	12,300	10,600	13,500	12,500	12,500
85	14,100	11,700	10,200	14,700	12,000	10,400	13,500	12,200	10,500
90	13,600	11,400	10,000	14,200	11,700	10,200	13,500	11,900	10,300
95	13,200	11,100	9,800	13,700	11,400	10,000	13,500	11,700	10,100
100	12,800	10,800	9,700	13,300	11,100	9,800	13,500	11,400	10,000
105	12,400	10,600	9,500	12,900	10,900	9,700	13,400	11,100	9,800
110	12,000	10,300	9,300	12,500	10,600	9,500	13,000	10,900	9,600
115	11,600	10,100	9,200	12,200	10,400	9,300	12,700	10,700	9,500
120	11,300	9,900	9,000	11,800	10,200	9,200	12,300	10,500	9,400
125	11,000	9,700	8,900	11,500	10,000	9,100	12,000	10,200	9,200
130	10,700	9,500	8,800	11,200	9,800	8,900	11,700	10,000	9,100
135	10,400	9,300	8,700	10,900	9,600	8,800	11,400	9,900	9,000
140	10,200	9,100	8,500	10,700	9,400	8,700	10,600	9,700	8,900
145	9,900	8,900	8,500	10,400	9,200	8,600	9,700	9,500	8,800
150	9,700	8,800	8,400	9,700	9,100	8,500	8,800	9,400	8,700
155	9,400	8,600	8,300	8,900	8,900	8,400	8,000	8,900	8,600
160	9,100	8,500	8,200	8,200	8,800	8,300	7,200	8,100	8,500
165	8,600	8,400	8,200	7,500	8,200	8,300	6,500	7,300	8,100
170	7,900	8,300	8,100	6,800	7,500	8,000	5,900	6,600	7,300
175	7,300	7,800	8,100	6,200	6,800	7,300	5,200	5,900	6,600
180	6,700	7,100	7,500	5,600	6,200	6,600	4,700	5,300	5,900
185	6,200	6,600	6,800	5,100	5,600	6,000	4,100	4,700	5,300
190	5,700	6,000	6,100	4,600	5,000	5,400	3,600	4,200	4,700
195	5,200	5,500		4,100	4,500	4,800	3,100	3,700	4,100
200	4,700	5,000		3,600	4,000	4,200	2,700	3,200	3,600
205	4,300			3,200	3,500	3,600	2,200	2,700	3,000
210				2,800	3,100	3,000		2,200	2,500
215				2,400	2,600				
220				2,100					

Min Angle	7.5	11.0	29.5	18.5	21.5	20.5	37.5	38.0	38.0
Max Rad.	209.5	204.1	195.0	221.3	220.0	211.7	207.5	212.5	215.0
Capacity	0	0	0	0	0	0	0	0	0

1062080



PORTLAND OFFICE: 503.283.3111
 SEATTLE OFFICE: 206.784.1054
WWW.NESSCAMPBELL.COM

Rated Lifting Capacities in Pounds

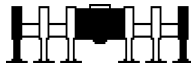

Full

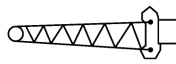

67ft Hydraulic Offset Fly



80,000 lbs



Radius (ft)	Boom Length (ft)											
	Fly Offset											
	44.3			73.5			103.8			119.4		
	2°-15°	15°-30°	30°-45°	2°-15°	15°-30°	30°-45°	2°-15°	15°-30°	30°-45°	2°-15°	15°-30°	30°-45°
15	30,000											
20	27,800			27,500								
25	19,800	19,800		27,500			18,200					
30	18,100	18,100		19,900	19,900		18,200			17,800		
35	16,600	16,600		18,500	18,500		18,200			17,800		
40	15,400	13,700	13,700	17,300	17,300		18,100	18,100		17,700	17,700	
45	14,300	12,800	12,800	16,200	13,700	13,700	17,700	17,700		17,700	17,700	
50	13,300	12,100	11,100	15,300	13,100	13,100	16,800	13,800	13,800	17,400	17,400	
55	12,500	11,400	10,600	14,400	12,400	11,100	15,900	13,200	13,200	16,600	13,500	13,500
60	11,700	10,800	10,100	13,600	11,900	10,700	15,200	12,700	12,700	15,800	13,000	13,000
65	11,100	10,300	9,700	12,900	11,400	10,300	14,500	12,200	10,800	15,200	12,600	12,600
70	10,500	9,800	9,300	12,300	10,900	10,000	13,800	11,800	10,500	14,500	12,100	10,600
75	9,900	9,300	8,900	11,700	10,500	9,700	13,200	11,400	10,200	13,900	11,700	10,400
80	9,400	8,900	8,600	11,200	10,100	9,400	12,700	11,000	9,900	13,400	11,400	10,100
85	9,000	8,600	8,400	10,700	9,800	9,100	12,200	10,600	9,700	12,900	11,000	9,900
90	8,600	8,300	8,200	10,300	9,400	8,900	11,700	10,300	9,400	12,400	10,700	9,700
95	8,200	8,000	8,000	9,900	9,100	8,700	11,300	10,000	9,200	12,000	10,400	9,400
100	7,900	7,900		9,500	8,900	8,500	10,900	9,700	9,000	11,500	10,100	9,300
105				9,100	8,600	8,300	10,500	9,500	8,900	11,200	9,900	9,100
110				8,800	8,400	8,200	10,200	9,200	8,700	10,800	9,600	8,900
115				8,500	8,200	8,200	9,800	9,000	8,500	10,500	9,400	8,800
120				8,300	8,000	8,000	9,500	8,800	8,400	10,200	9,200	8,600
125				8,100	8,000	8,000	9,300	8,600	8,300	9,900	9,000	8,500
130							9,000	8,400	8,200	9,600	8,800	8,400
135							8,800	8,300	8,200	9,300	8,600	8,300
140							8,500	8,200	8,200	9,100	8,500	8,200
145							8,300	8,000	8,000	8,800	8,300	8,200
150							8,100	8,000		8,600	8,200	8,200
155							8,000			8,400	8,100	8,100
160										8,300	8,000	8,000
165										8,100	8,000	
170										8,000		
Min Angle	0.0	0.0	0.0	14.0	18.5	0.0	15.5	27.0	11.5	16.5	27.0	12.5
Max Rad.	102.9	102.7	100.7	130.0	130.0	128.9	160.0	155.0	146.4	175.0	170.0	162.0
Capacity	6,200	6,400	7,000	0	0	2,000	0	0	0	0	0	0

1062090



PORTLAND OFFICE: 503.283.3111
 SEATTLE OFFICE: 206.784.1054
WWW.NESSCAMPBELL.COM

Rated Lifting Capacities in Pounds

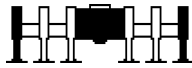

Full

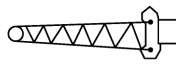

67ft Hydraulic Offset Fly



80,000 lbs



Radius (ft)	Boom Length (ft)								
	Fly Offset								
	135.4			152.0			168.5		
	2°-15°	15°-30°	30°-45°	2°-15°	15°-30°	30°-45°	2°-15°	15°-30°	30°-45°
35	18,100			17,400			15,300		
40	18,100			17,400			15,300		
45	18,000	18,000		17,400			15,300		
50	18,000	18,000		17,300	17,300		15,200	15,200	
55	17,200	17,200		17,300	17,300		15,200	15,200	
60	16,500	13,300	13,300	17,100	17,100		15,200	15,200	
65	15,800	12,900	12,900	16,400	13,100	13,100	15,200	15,200	
70	15,100	12,500	12,500	15,700	12,700	10,900	15,200	13,000	13,000
75	14,500	12,100	10,500	15,200	12,400	10,700	15,200	12,600	12,600
80	14,000	11,700	10,300	14,600	12,000	10,500	15,200	12,300	10,600
85	13,500	11,400	10,100	14,100	11,700	10,200	14,600	12,000	10,400
90	13,000	11,100	9,900	13,600	11,400	10,000	14,200	11,700	10,200
95	12,600	10,800	9,600	13,200	11,100	9,800	13,700	11,400	10,000
100	12,200	10,500	9,500	12,700	10,800	9,600	13,300	11,100	9,800
105	11,800	10,200	9,300	12,400	10,600	9,500	12,900	10,900	9,600
110	11,400	10,000	9,100	12,000	10,300	9,300	12,500	10,600	9,500
115	11,100	9,700	9,000	11,600	10,100	9,200	12,200	10,400	9,300
120	10,700	9,500	8,800	11,300	9,900	9,000	11,800	10,200	9,200
125	10,400	9,300	8,700	11,000	9,600	8,900	11,500	10,000	9,100
130	10,100	9,100	8,600	10,700	9,500	8,800	11,200	9,800	8,900
135	9,900	8,900	8,500	10,400	9,300	8,700	10,900	9,600	8,800
140	9,600	8,800	8,400	10,100	9,100	8,500	10,600	9,400	8,700
145	9,400	8,600	8,300	9,900	8,900	8,500	10,400	9,200	8,600
150	9,100	8,500	8,200	9,700	8,800	8,400	9,800	9,100	8,500
155	8,900	8,300	8,200	9,400	8,600	8,300	9,000	8,900	8,400
160	8,700	8,200	8,100	9,200	8,500	8,200	8,200	8,800	8,300
165	8,500	8,100	8,100	8,600	8,400	8,200	7,500	8,200	8,300
170	8,400	8,000	8,000	8,000	8,300	8,100	6,900	7,500	8,100
175	8,200	8,000	8,000	7,400	7,800	8,100	6,200	6,800	7,400
180	8,100	8,000		6,800	7,200	7,500	5,700	6,200	6,700
185	7,500			6,200	6,600	6,900	5,100	5,600	6,000
190				5,700	6,000	6,100	4,600	5,100	5,400
195				5,200	5,500		4,100	4,500	4,900
200				4,800	5,000		3,700	4,000	4,300
205							3,300	3,600	3,700
210							2,800	3,100	3,000
215							2,500	2,700	
220							2,100		
Min Angle	17.5	26.5	12.5	20.5	9.5	10.0	17.5	20.0	22.0
Max Rad. Capacity	190.0	185.0	178.1	205.0	203.6	194.6	221.7	220.0	211.2
	0	0	0	0	0	0	0	0	0

1062090



PORTLAND OFFICE: 503.283.3111
 SEATTLE OFFICE: 206.784.1054
WWW.NESSCAMPBELL.COM

Rated Lifting Capacities in Pounds

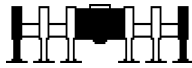

Full

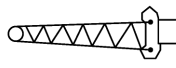

92ft Offset Fly



80,000 lbs



Radius (ft)	Boom Length (ft)											
	Fly Offset											
	44.3				73.5				103.8			
	2°	15°	30°	45°	2°	15°	30°	45°	2°	15°	30°	45°
20	19,800											
25	18,100				17,300							
30	16,700				17,300				15,200			
35	15,500	14,400			17,300				15,200			
40	14,400	13,400			16,300	14,600			15,200			
45	13,400	12,600	11,900		15,300	13,800			15,200	14,700		
50	12,600	11,800	11,200		14,400	13,100			15,200	14,000		
55	11,800	11,200	10,600		13,600	12,400	11,400		15,200	13,400		
60	11,100	10,500	10,000	9,700	12,900	11,800	10,900		14,400	12,800	11,500	
65	10,500	10,000	9,500	9,300	12,200	11,200	10,400	9,800	13,700	12,200	11,000	
70	9,900	9,500	9,100	8,800	11,600	10,700	10,000	9,400	13,100	11,700	10,600	9,800
75	9,400	9,000	8,700	8,400	11,000	10,200	9,500	9,100	12,500	11,300	10,200	9,500
80	8,900	8,600	8,300	8,100	10,500	9,800	9,200	8,700	12,000	10,800	9,900	9,200
85	8,400	8,100	7,800	7,700	10,000	9,400	8,800	8,400	11,500	10,400	9,500	8,900
90	7,900	7,700	7,400	7,300	9,600	9,000	8,500	8,200	11,000	10,000	9,200	8,700
95	7,400	7,200	7,100	7,000	9,200	8,700	8,200	7,900	10,600	9,700	8,900	8,400
100	7,000	6,800	6,700	6,600	8,800	8,300	7,800	7,600	10,200	9,300	8,600	8,200
105	6,500	6,400	6,300	6,300	8,400	7,900	7,500	7,300	9,800	9,000	8,400	8,000
110	6,100	6,000	6,000	6,000	8,000	7,600	7,200	7,000	9,400	8,700	8,100	7,700
115	5,800	5,700	5,700		7,600	7,200	6,900	6,800	9,100	8,400	7,800	7,500
120	5,400	5,400	5,400		7,200	6,900	6,600	6,500	8,800	8,100	7,600	7,300
125	5,100	5,100			6,800	6,500	6,300	6,300	8,400	7,800	7,300	7,100
130					6,500	6,200	6,100	6,100	8,100	7,500	7,100	6,900
135					6,100	6,000	5,800	5,900	7,700	7,200	6,800	6,700
140					5,800	5,700	5,600		7,400	6,900	6,600	6,400
145					5,600	5,500	5,400		7,000	6,700	6,400	6,300
150					5,300	5,200			6,700	6,400	6,200	6,100
155									6,400	6,200	6,000	5,900
160									6,200	5,900	5,800	5,800
165									5,900	5,700	5,600	
170									5,700	5,500	5,400	
175									5,500	5,300	5,300	
180									5,300	5,200		
Min Angle	0.0	0.0	0.0	0.0	14.0	17.0	26.5	26.0	15.5	17.5	25.0	22.5
Max Rad.	127.9	127.5	124.9	120.1	155.0	155.0	150.0	141.2	185.0	185.0	180.0	171.4
Capacity	3,100	3,100	3,400	3,900	0	0	0	0	0	0	0	0

1061100



PORTLAND OFFICE: 503.283.3111
 SEATTLE OFFICE: 206.784.1054
WWW.NESSCAMPBELL.COM

Rated Lifting Capacities in Pounds

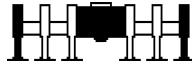

Full

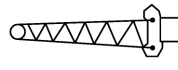

92ft Offset Fly



80,000 lbs



Radius (ft)	Boom Length (ft)											
	Fly Offset											
	134.9				167.1				183.6			
	2°	15°	30°	45°	2°	15°	30°	45°	2°	15°	30°	45°
35	12,900											
40	12,900											
45	12,900				10,400							
50	12,900				10,400				9,600			
55	12,900	12,800			10,400				9,600			
60	12,900	12,800			10,400	10,300			9,600			
65	12,900	12,800			10,400	10,300			9,600			
70	12,900	12,600	11,200		10,400	10,300			9,600	9,500		
75	12,900	12,200	10,800		10,400	10,300			9,600	9,500		
80	12,900	11,700	10,500	9,600	10,400	10,300	10,200		9,600	9,500		
85	12,800	11,300	10,100	9,300	10,400	10,300	10,200		9,600	9,500	9,400	
90	12,300	10,900	9,800	9,100	10,400	10,300	10,200	9,400	9,600	9,500	9,400	
95	11,800	10,600	9,500	8,900	10,400	10,300	10,100	9,200	9,600	9,500	9,400	9,300
100	11,400	10,200	9,300	8,600	10,400	10,300	9,800	9,000	9,600	9,500	9,400	9,100
105	11,000	9,900	9,000	8,400	10,400	10,300	9,500	8,800	9,600	9,500	9,400	9,000
110	10,600	9,600	8,800	8,200	10,400	10,300	9,300	8,600	9,600	9,500	9,400	8,800
115	10,300	9,300	8,500	8,000	10,400	10,100	9,100	8,400	9,600	9,500	9,300	8,600
120	9,900	9,000	8,300	7,800	10,400	9,800	8,900	8,300	9,600	9,500	9,100	8,400
125	9,600	8,800	8,100	7,600	10,400	9,600	8,700	8,100	9,600	9,500	8,900	8,300
130	9,300	8,500	7,900	7,400	10,400	9,300	8,500	7,900	9,600	9,500	8,700	8,100
135	9,000	8,300	7,600	7,300	10,000	9,100	8,300	7,700	9,600	9,400	8,500	8,000
140	8,700	8,000	7,400	7,100	9,800	8,800	8,100	7,600	9,600	9,200	8,300	7,800
145	8,400	7,700	7,200	6,900	9,300	8,600	7,900	7,400	9,600	9,000	8,200	7,600
150	8,100	7,500	7,000	6,700	8,800	8,400	7,700	7,200	9,600	8,800	8,000	7,500
155	7,800	7,200	6,800	6,600	8,300	8,200	7,500	7,100	9,100	8,600	7,800	7,300
160	7,500	7,000	6,600	6,400	7,800	7,900	7,300	7,000	8,400	8,300	7,600	7,200
165	7,200	6,800	6,400	6,300	7,300	7,600	7,100	6,800	7,700	8,100	7,400	7,000
170	6,900	6,500	6,200	6,100	6,900	7,200	7,000	6,700	7,000	7,700	7,300	6,900
175	6,500	6,300	6,000	6,000	6,500	6,800	6,800	6,500	6,400	7,100	7,100	6,800
180	6,200	6,100	5,900	5,900	6,100	6,400	6,600	6,400	5,800	6,500	6,900	6,600
185	5,900	5,900	5,700	5,800	5,700	6,000	6,200	6,300	5,200	5,900	6,500	6,500
190	5,500	5,700	5,600		5,300	5,600	5,800	5,900	4,700	5,300	5,900	6,200
195	5,200	5,400	5,400		5,000	5,200	5,400	5,600	4,200	4,800	5,300	5,600
200	5,000	5,100	5,100		4,700	4,900	5,100	5,200	3,800	4,300	4,800	5,000
205	4,700	4,800	4,800		4,300	4,600	4,800	4,800	3,300	3,800	4,200	4,500
210	4,500	4,500			3,900	4,300	4,400	4,500	2,900	3,400	3,800	3,900
215					3,500	3,900	4,100	4,100	2,500	2,900	3,300	3,400
220					3,100	3,500	3,700		2,100	2,500	2,800	2,900
225					2,800	3,100	3,200			2,100	2,400	2,500
230					2,500	2,700	2,800					
235					2,100	2,300	2,400					
Min Angle	18.0	20.0	26.0	19.5	25.5	26.5	26.0	21.5	41.5	41.5	42.0	42.0
Max Rad. Capacity	215.0	215.0	210.0	202.6	237.5	240.0	240.0	234.7	221.7	226.7	230.0	230.0
	0	0	0	0	0	0	0	0	0	0	0	0

1061100



PORTLAND OFFICE: 503.283.3111
 SEATTLE OFFICE: 206.784.1054
WWW.NESSCAMPBELL.COM

Rated Lifting Capacities in Pounds

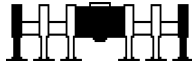

Full

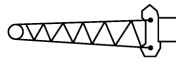

92ft Offset Fly



80,000 lbs



Radius (ft)	Boom Length (ft)			
	Fly Offset			
	200.1			
	2°	15°	30°	45°
55	8,200			
60	8,200			
65	8,200			
70	8,200			
75	8,200	8,100		
80	8,200	8,100		
85	8,200	8,100		
90	8,200	8,100	8,000	
95	8,200	8,100	8,000	
100	8,200	8,100	8,000	7,800
105	8,200	8,100	8,000	7,800
110	8,200	8,100	8,000	7,800
115	8,200	8,100	8,000	7,800
120	8,200	8,100	8,000	7,800
125	8,200	8,100	8,000	7,800
130	8,200	8,100	8,000	7,800
135	8,200	8,100	8,000	7,800
140	8,200	8,100	8,000	7,800
145	8,200	8,100	8,000	7,800
150	8,200	8,100	8,000	7,700
155	8,200	8,100	8,000	7,500
160	7,500	8,100	7,900	7,400
165	6,800	7,600	7,700	7,200
170	6,100	6,900	7,500	7,100
175	5,500	6,300	7,000	7,000
180	4,900	5,600	6,300	6,800
185	4,300	5,000	5,700	6,200
190	3,800	4,500	5,100	5,500
195	3,300	4,000	4,500	4,900
200	2,800	3,500	4,000	4,300
205	2,400	3,000	3,500	3,800
210		2,500	3,000	3,300
215		2,100	2,600	2,800
220			2,100	2,300
Min Angle	49.5	50.0	51.0	51.0
Max Rad. Capacity	210.0	216.3	221.3	223.0
	0	0	0	0

1061100



PORTLAND OFFICE: 503.283.3111
 SEATTLE OFFICE: 206.784.1054
WWW.NESSCAMPBELL.COM

Rated Lifting Capacities in Pounds

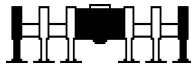

Full

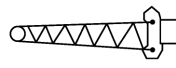

92ft Offset Fly



80,000 lbs



Radius (ft)	Boom Length (ft)											
	Fly Offset											
	44.3				58.9				89.1			
	2°	15°	30°	45°	2°	15°	30°	45°	2°	15°	30°	45°
20	19,800				19,700							
25	18,100				19,200				18,900			
30	16,700				17,700				18,900			
35	15,500	14,400			16,500	15,000			18,300			
40	14,400	13,400			15,400	14,100			17,100	15,100		
45	13,400	12,600	11,900		14,400	13,300			16,200	14,300		
50	12,600	11,800	11,200		13,500	12,500	11,600		15,300	13,600		
55	11,800	11,200	10,600		12,700	11,800	11,000		14,400	12,900	11,700	
60	11,100	10,500	10,000	9,700	12,000	11,200	10,500	10,000	13,700	12,300	11,200	
65	10,500	10,000	9,500	9,300	11,400	10,600	10,000	9,600	13,000	11,800	10,700	
70	9,900	9,500	9,100	8,800	10,800	10,100	9,600	9,200	12,400	11,300	10,300	9,700
75	9,400	9,000	8,700	8,400	10,200	9,600	9,100	8,800	11,800	10,800	9,900	9,300
80	8,900	8,600	8,300	8,100	9,700	9,200	8,700	8,400	11,300	10,400	9,600	9,000
85	8,400	8,100	7,800	7,700	9,300	8,800	8,400	8,100	10,800	9,900	9,200	8,700
90	7,900	7,700	7,400	7,300	8,900	8,400	8,000	7,800	10,300	9,600	8,900	8,400
95	7,400	7,200	7,100	7,000	8,400	8,000	7,700	7,500	9,900	9,200	8,600	8,200
100	7,000	6,800	6,700	6,600	8,000	7,600	7,300	7,200	9,500	8,900	8,300	7,900
105	6,500	6,400	6,300	6,300	7,500	7,200	7,000	6,900	9,200	8,500	8,000	7,700
110	6,100	6,000	6,000	6,000	7,100	6,800	6,600	6,600	8,800	8,200	7,700	7,400
115	5,800	5,700	5,700		6,700	6,500	6,300	6,300	8,400	7,900	7,400	7,200
120	5,400	5,400	5,400		6,300	6,200	6,000	6,000	8,000	7,600	7,200	7,000
125	5,100	5,100			6,000	5,800	5,800		7,700	7,200	6,900	6,700
130					5,700	5,600	5,500		7,300	6,900	6,600	6,500
135					5,400	5,300			7,000	6,600	6,400	6,300
140									6,600	6,300	6,100	6,100
145									6,300	6,100	5,900	5,900
150									6,000	5,800	5,700	
155									5,800	5,600	5,500	
160									5,500	5,400	5,400	
165									5,300	5,200		
Min Angle	0.0	0.0	0.0	0.0	14.5	18.5	28.5	9.5	15.0	18.0	26.0	18.5
Max Rad.	127.9	127.5	124.9	120.1	140.0	140.0	135.0	126.6	170.0	170.0	165.0	156.8
Capacity	3,100	3,100	3,400	3,900	0	0	0	0	0	0	0	0

1061110



PORTLAND OFFICE: 503.283.3111
 SEATTLE OFFICE: 206.784.1054
WWW.NESSCAMPBELL.COM

Rated Lifting Capacities in Pounds

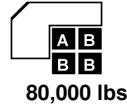
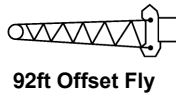
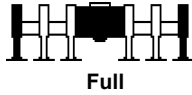

Radius (ft)	Boom Length (ft)											
	Fly Offset											
	120.3				152.4				169.0			
	2°	15°	30°	45°	2°	15°	30°	45°	2°	15°	30°	45°
35	16,500											
40	16,500				13,500							
45	16,500				13,500							
50	16,500	14,500			13,500				12,500			
55	15,900	13,900			13,500				12,500			
60	15,200	13,300			13,500	13,400			12,500			
65	14,500	12,700	11,300		13,500	13,400			12,500	12,400		
70	13,800	12,200	10,900		13,500	13,000			12,500	12,400		
75	13,200	11,800	10,500	9,700	13,500	12,600	11,100		12,500	12,400		
80	12,700	11,300	10,200	9,400	13,500	12,200	10,700		12,500	12,400	10,900	
85	12,200	10,900	9,900	9,200	13,400	11,800	10,400	9,500	12,500	12,100	10,700	
90	11,700	10,500	9,600	8,900	12,900	11,400	10,100	9,300	12,500	11,800	10,400	
95	11,200	10,200	9,300	8,700	12,500	11,000	9,800	9,100	12,500	11,400	10,100	9,200
100	10,800	9,800	9,000	8,400	12,000	10,700	9,600	8,800	12,500	11,100	9,800	9,000
105	10,400	9,500	8,700	8,200	11,600	10,300	9,300	8,600	12,200	10,700	9,600	8,800
110	10,100	9,200	8,500	8,000	11,200	10,000	9,100	8,400	11,800	10,400	9,300	8,600
115	9,700	8,900	8,300	7,800	10,900	9,800	8,800	8,300	11,400	10,100	9,100	8,500
120	9,400	8,600	8,000	7,600	10,500	9,500	8,600	8,100	11,100	9,900	8,900	8,300
125	9,100	8,400	7,700	7,400	10,200	9,200	8,400	7,900	10,700	9,600	8,700	8,100
130	8,800	8,100	7,500	7,200	9,900	9,000	8,200	7,700	10,400	9,300	8,500	7,900
135	8,400	7,800	7,300	7,000	9,600	8,700	8,000	7,500	10,100	9,100	8,300	7,800
140	8,100	7,500	7,100	6,800	9,300	8,500	7,800	7,400	9,800	8,900	8,100	7,600
145	7,800	7,300	6,800	6,600	9,000	8,200	7,600	7,200	9,500	8,700	7,900	7,400
150	7,500	7,000	6,600	6,500	8,800	8,000	7,400	7,000	9,300	8,400	7,700	7,300
155	7,200	6,700	6,400	6,300	8,500	7,800	7,200	6,900	9,000	8,200	7,500	7,100
160	6,900	6,500	6,200	6,100	8,200	7,500	7,000	6,700	8,200	8,000	7,300	7,000
165	6,600	6,300	6,000	6,000	7,700	7,300	6,800	6,600	7,500	7,800	7,200	6,800
170	6,400	6,100	5,900	5,800	7,200	7,100	6,600	6,400	6,800	7,500	7,000	6,700
175	6,100	5,900	5,700		6,800	6,900	6,500	6,300	6,200	6,900	6,800	6,600
180	5,900	5,700	5,500		6,400	6,600	6,300	6,200	5,600	6,300	6,600	6,400
185	5,700	5,500	5,400		6,000	6,300	6,100	6,000	5,100	5,700	6,200	6,300
190	5,500	5,300	5,300		5,600	5,900	6,000	5,900	4,500	5,100	5,600	5,900
195	5,300	5,200			5,100	5,500	5,700	5,800	4,100	4,600	5,000	5,300
200					4,700	5,100	5,400	5,400	3,600	4,100	4,500	4,700
205					4,200	4,600	4,800		3,200	3,600	4,000	4,100
210					3,800	4,100	4,300		2,700	3,200	3,500	3,600
215					3,400	3,700	3,900		2,300	2,700	3,000	
220					3,100	3,300	3,400			2,300	2,600	
225					2,700	2,900					2,100	
230					2,400	2,500						
Min Angle	18.0	20.0	26.5	17.0	12.0	15.5	15.5	28.0	36.0	36.5	36.5	35.5
Max Rad.	200.0	200.0	195.0	188.0	235.0	232.8	229.1	220.0	220.0	223.8	226.3	226.0
Capacity	0	0	0	0	0	0	0	0	0	0	0	0

1061110



PORTLAND OFFICE: 503.283.3111
SEATTLE OFFICE: 206.784.1054
WWW.NESSCAMPBELL.COM

Rated Lifting Capacities in Pounds

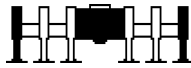

Full

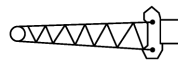

92ft Offset Fly



80,000 lbs



Radius (ft)	Boom Length (ft)			
	Fly Offset			
	185.5			
	2°	15°	30°	45°
50	10,700			
55	10,700			
60	10,700			
65	10,700			
70	10,700	10,600		
75	10,700	10,600		
80	10,700	10,600		
85	10,700	10,600	10,400	
90	10,700	10,600	10,400	
95	10,700	10,600	10,300	
100	10,700	10,600	10,100	9,200
105	10,700	10,600	9,800	9,000
110	10,700	10,600	9,600	8,800
115	10,700	10,500	9,400	8,600
120	10,700	10,200	9,100	8,400
125	10,700	10,000	8,900	8,300
130	10,700	9,700	8,700	8,100
135	10,600	9,500	8,500	8,000
140	10,300	9,200	8,400	7,800
145	9,700	9,000	8,200	7,600
150	8,800	8,800	8,000	7,500
155	8,000	8,600	7,800	7,300
160	7,300	8,200	7,600	7,200
165	6,600	7,400	7,500	7,100
170	5,900	6,700	7,300	6,900
175	5,300	6,000	6,800	6,800
180	4,700	5,400	6,100	6,600
185	4,100	4,800	5,500	5,900
190	3,600	4,300	4,900	5,200
195	3,100	3,700	4,300	4,600
200	2,700	3,200	3,800	4,000
205	2,200	2,800	3,200	3,500
210		2,300	2,700	2,900
215			2,300	2,400
Min Angle	46.0	47.0	47.0	46.5
Max Rad. Capacity	207.5	213.8	218.0	220.0
Capacity	0	0	0	0

1061110



PORTLAND OFFICE: 503.283.3111
 SEATTLE OFFICE: 206.784.1054
WWW.NESSCAMPBELL.COM

Rated Lifting Capacities in Pounds

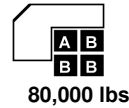
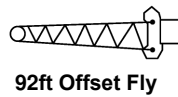
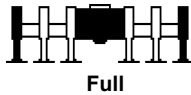

Radius (ft)	Boom Length (ft)											
	Fly Offset											
	44.3				73.5				103.8			
	2°	15°	30°	45°	2°	15°	30°	45°	2°	15°	30°	45°
20	19,800											
25	18,100				17,300							
30	16,700				17,300				15,200			
35	15,500	14,400			17,300				15,200			
40	14,400	13,400			16,300	14,600			15,200			
45	13,400	12,600	11,900		15,300	13,800			15,200	14,700		
50	12,600	11,800	11,200		14,400	13,100			15,200	14,000		
55	11,800	11,200	10,600		13,600	12,400	11,400		15,200	13,400		
60	11,100	10,500	10,000	9,700	12,900	11,800	10,900		14,400	12,800	11,500	
65	10,500	10,000	9,500	9,300	12,200	11,200	10,400	9,800	13,700	12,200	11,000	
70	9,900	9,500	9,100	8,800	11,600	10,700	10,000	9,400	13,100	11,700	10,600	9,800
75	9,400	9,000	8,700	8,400	11,000	10,200	9,500	9,100	12,500	11,300	10,200	9,500
80	8,900	8,600	8,300	8,100	10,500	9,800	9,200	8,700	12,000	10,800	9,900	9,200
85	8,400	8,100	7,800	7,700	10,000	9,400	8,800	8,400	11,500	10,400	9,500	8,900
90	7,900	7,700	7,400	7,300	9,600	9,000	8,500	8,200	11,000	10,000	9,200	8,700
95	7,400	7,200	7,100	7,000	9,200	8,700	8,200	7,900	10,600	9,700	8,900	8,400
100	7,000	6,800	6,700	6,600	8,800	8,300	7,800	7,600	10,200	9,300	8,600	8,200
105	6,500	6,400	6,300	6,300	8,400	7,900	7,500	7,300	9,800	9,000	8,400	8,000
110	6,100	6,000	6,000	6,000	8,000	7,600	7,200	7,000	9,400	8,700	8,100	7,700
115	5,800	5,700	5,700		7,600	7,200	6,900	6,800	9,100	8,400	7,800	7,500
120	5,400	5,400	5,400		7,200	6,900	6,600	6,500	8,800	8,100	7,600	7,300
125	5,100	5,100			6,800	6,500	6,300	6,300	8,400	7,800	7,300	7,100
130					6,500	6,200	6,100	6,100	8,100	7,500	7,100	6,900
135					6,100	6,000	5,800	5,900	7,700	7,200	6,800	6,700
140					5,800	5,700	5,600		7,400	6,900	6,600	6,400
145					5,600	5,500	5,400		7,000	6,700	6,400	6,300
150					5,300	5,200			6,700	6,400	6,200	6,100
155									6,400	6,200	6,000	5,900
160									6,200	5,900	5,800	5,800
165									5,900	5,700	5,600	
170									5,700	5,500	5,400	
175									5,500	5,300	5,300	
180									5,300	5,200		
Min Angle	0.0	0.0	0.0	0.0	14.0	17.0	26.5	26.0	15.5	17.5	25.0	22.5
Max Rad.	127.9	127.5	124.9	120.1	155.0	155.0	150.0	141.2	185.0	185.0	180.0	171.4
Capacity	3,100	3,100	3,400	3,900	0	0	0	0	0	0	0	0

1061120



PORTLAND OFFICE: 503.283.3111
 SEATTLE OFFICE: 206.784.1054
WWW.NESSCAMPBELL.COM

Rated Lifting Capacities in Pounds

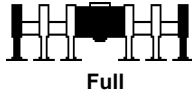

Full

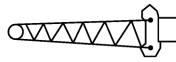

92ft Offset Fly

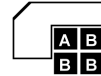

80,000 lbs



Radius (ft)	Boom Length (ft)											
	Fly Offset											
	119.4				135.4				152.0			
	2°	15°	30°	45°	2°	15°	30°	45°	2°	15°	30°	45°
35	14,900				14,900							
40	14,900				14,900				14,100			
45	14,900				14,900				14,100			
50	14,900	14,500			14,900				14,100			
55	14,900	13,800			14,900	14,200			14,100			
60	14,900	13,300			14,900	13,700			14,100	14,000		
65	14,400	12,700	11,300		14,900	13,100			14,100	13,500		
70	13,800	12,200	10,900		14,500	12,600	11,200		14,100	13,000	11,400	
75	13,200	11,700	10,500	9,700	13,900	12,200	10,800		14,100	12,600	11,100	
80	12,600	11,300	10,200	9,400	13,300	11,700	10,500	9,600	13,900	12,100	10,700	
85	12,100	10,900	9,900	9,200	12,800	11,300	10,100	9,300	13,400	11,700	10,400	9,500
90	11,700	10,500	9,500	8,900	12,300	10,900	9,800	9,100	12,900	11,400	10,100	9,300
95	11,200	10,100	9,300	8,700	11,800	10,600	9,500	8,900	12,500	11,000	9,800	9,100
100	10,800	9,800	9,000	8,400	11,400	10,200	9,300	8,600	12,000	10,700	9,600	8,800
105	10,400	9,500	8,700	8,200	11,000	9,900	9,000	8,400	11,600	10,300	9,300	8,600
110	10,000	9,200	8,500	8,000	10,600	9,600	8,800	8,200	11,200	10,000	9,100	8,400
115	9,700	8,900	8,200	7,800	10,300	9,300	8,500	8,000	10,900	9,700	8,800	8,300
120	9,400	8,600	8,000	7,600	9,900	9,100	8,300	7,800	10,500	9,500	8,600	8,100
125	9,000	8,300	7,700	7,400	9,600	8,800	8,100	7,600	10,200	9,200	8,400	7,900
130	8,700	8,000	7,500	7,200	9,300	8,500	7,900	7,400	9,900	9,000	8,200	7,700
135	8,400	7,800	7,300	7,000	9,000	8,300	7,600	7,300	9,600	8,700	8,000	7,500
140	8,100	7,500	7,100	6,800	8,700	8,000	7,400	7,100	9,300	8,500	7,800	7,300
145	7,800	7,200	6,800	6,600	8,400	7,800	7,200	6,900	9,000	8,200	7,600	7,200
150	7,500	7,000	6,600	6,400	8,100	7,500	7,000	6,800	8,800	8,000	7,400	7,000
155	7,200	6,700	6,400	6,300	7,900	7,300	6,800	6,600	8,500	7,700	7,200	6,900
160	6,900	6,500	6,200	6,100	7,600	7,000	6,600	6,400	8,200	7,500	7,000	6,700
165	6,600	6,200	6,000	6,000	7,300	6,800	6,400	6,300	7,900	7,300	6,800	6,600
170	6,300	6,000	5,800	5,800	7,000	6,500	6,200	6,100	7,700	7,100	6,600	6,400
175	6,100	5,800	5,700		6,700	6,300	6,100	6,000	7,300	6,800	6,400	6,300
180	5,900	5,600	5,500		6,500	6,100	5,900	5,900	6,700	6,600	6,300	6,100
185	5,600	5,500	5,400		6,200	5,900	5,700	5,800	6,200	6,400	6,100	6,000
190	5,400	5,300	5,300		6,000	5,800	5,600		5,700	6,100	6,000	5,900
195	5,300	5,200			5,800	5,600	5,500		5,200	5,600	5,800	5,800
200					5,600	5,400	5,400		4,700	5,100	5,400	5,500
205					5,400	5,300	5,300		4,300	4,600	4,900	
210					5,100	5,200			3,900	4,200	4,400	
215									3,500	3,700	3,900	
220									3,100	3,300	3,400	
225									2,800	2,900		
230									2,500			
Min Angle	16.5	19.0	25.5	19.5	18.0	20.0	26.0	16.5	16.5	20.5	12.5	14.0
Max Rad.	200.0	200.0	195.0	187.0	215.0	215.0	210.0	203.1	231.1	230.0	228.6	219.6
Capacity	0	0	0	0	0	0	0	0	0	0	0	0

1061120



PORTLAND OFFICE: 503.283.3111
 SEATTLE OFFICE: 206.784.1054
 WWW.NESSCAMPBELL.COM

Rated Lifting Capacities in Pounds

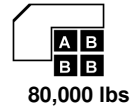
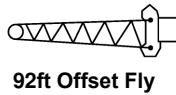
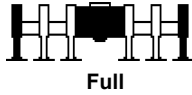

Radius (ft)	Boom Length (ft)			
	Fly Offset			
	168.5			
	2°	15°	30°	45°
45	12,200			
50	12,200			
55	12,200			
60	12,200	12,100		
65	12,200	12,100		
70	12,200	12,100		
75	12,200	12,100		
80	12,200	12,100	10,900	
85	12,200	12,100	10,600	
90	12,200	11,700	10,400	9,400
95	12,200	11,400	10,100	9,200
100	12,200	11,100	9,800	9,000
105	12,200	10,700	9,600	8,800
110	11,800	10,400	9,300	8,600
115	11,400	10,100	9,100	8,400
120	11,100	9,800	8,900	8,300
125	10,700	9,600	8,700	8,100
130	10,400	9,300	8,500	7,900
135	10,100	9,100	8,300	7,800
140	9,800	8,900	8,100	7,600
145	9,500	8,600	7,900	7,400
150	9,300	8,400	7,700	7,300
155	9,000	8,200	7,500	7,100
160	8,300	8,000	7,300	7,000
165	7,600	7,700	7,200	6,800
170	6,900	7,500	7,000	6,700
175	6,300	6,900	6,800	6,500
180	5,700	6,300	6,600	6,400
185	5,100	5,700	6,300	6,300
190	4,600	5,200	5,700	5,900
195	4,100	4,600	5,100	5,300
200	3,600	4,100	4,500	4,700
205	3,200	3,700	4,000	4,200
210	2,800	3,200	3,500	3,600
215	2,400	2,800	3,100	
220		2,400	2,600	
225			2,200	
Min Angle	35.5	35.5	35.5	35.5
Max Rad.	220.0	225.0	227.5	226.0
Capacity	0	0	0	0

1061120



PORTLAND OFFICE: 503.283.3111
 SEATTLE OFFICE: 206.784.1054
WWW.NESSCAMPBELL.COM

Rated Lifting Capacities in Pounds

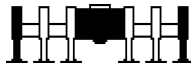

Full

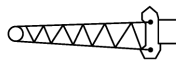

92ft Hydraulic Offset Fly



80,000 lbs



Radius (ft)	Boom Length (ft)											
	Fly Offset											
	44.3			73.5			103.8			134.9		
	2°-15°	15°-30°	30°-45°	2°-15°	15°-30°	30°-45°	2°-15°	15°-30°	30°-45°	2°-15°	15°-30°	30°-45°
20	19,800											
25	18,100			17,300								
30	15,500	15,500		17,300			15,200					
35	14,400	14,400		15,500	15,500		15,200			12,900		
40	13,400	13,400		14,600	14,600		15,200			12,900		
45	12,600	11,900	11,900	13,800	13,800		14,700	14,700		12,900		
50	11,800	11,200	11,200	13,100	11,900	11,900	14,000	14,000		12,800	12,800	
55	11,200	10,600	10,200	12,400	11,400	11,400	13,400	13,400		12,800	12,800	
60	10,500	10,000	9,700	11,800	10,900	10,200	12,800	11,500	11,500	12,800	12,800	
65	10,000	9,500	9,300	11,200	10,400	9,800	12,200	11,000	11,000	12,800	12,800	
70	9,500	9,100	8,800	10,700	10,000	9,400	11,700	10,600	9,800	12,600	11,200	11,200
75	9,000	8,700	8,400	10,200	9,500	9,100	11,300	10,200	9,500	12,200	10,800	10,800
80	8,600	8,300	8,100	9,800	9,200	8,700	10,800	9,900	9,200	11,700	10,500	9,600
85	8,100	7,800	7,700	9,400	8,800	8,400	10,400	9,500	8,900	11,300	10,100	9,300
90	7,700	7,400	7,300	9,000	8,500	8,200	10,000	9,200	8,700	10,900	9,800	9,100
95	7,200	7,100	7,000	8,700	8,200	7,900	9,700	8,900	8,400	10,600	9,500	8,900
100	6,800	6,700	6,600	8,300	7,800	7,600	9,300	8,600	8,200	10,200	9,300	8,600
105	6,400	6,300	6,300	7,900	7,500	7,300	9,000	8,400	8,000	9,900	9,000	8,400
110	6,000	6,000	6,000	7,600	7,200	7,000	8,700	8,100	7,700	9,600	8,800	8,200
115	5,700	5,700	5,700	7,200	6,900	6,800	8,400	7,800	7,500	9,300	8,500	8,000
120	5,400	5,400	5,400	6,900	6,600	6,500	8,100	7,600	7,300	9,000	8,300	7,800
125	5,100	5,100		6,500	6,300	6,300	7,800	7,300	7,100	8,800	8,100	7,600
130				6,200	6,100	6,100	7,500	7,100	6,900	8,500	7,900	7,400
135				6,000	5,800	5,800	7,200	6,800	6,700	8,300	7,600	7,300
140				5,700	5,600	5,600	6,900	6,600	6,400	8,000	7,400	7,100
145				5,500	5,400		6,700	6,400	6,300	7,700	7,200	6,900
150				5,200			6,400	6,200	6,100	7,500	7,000	6,700
155							6,200	6,000	5,900	7,200	6,800	6,600
160							5,900	5,800	5,800	7,000	6,600	6,400
165							5,700	5,600	5,600	6,800	6,400	6,300
170							5,500	5,400	5,400	6,500	6,200	6,100
175							5,300	5,300		6,300	6,000	6,000
180							5,200			6,100	5,900	5,900
185										5,900	5,700	5,700
190										5,500	5,600	5,600
195										5,200	5,400	5,400
200										5,000	5,100	5,100
205										4,700	4,800	
210										4,500		
Min Angle	0.0	0.0	0.0	14.0	26.5	26.0	15.5	25.0	22.5	18.0	26.0	19.5
Max Rad.	127.9	127.5	124.9	155.0	150.0	141.2	185.0	180.0	171.4	215.0	210.0	202.6
Capacity	3,100	3,100	3,400	0	0	0	0	0	0	0	0	0

1062100



PORTLAND OFFICE: 503.283.3111
 SEATTLE OFFICE: 206.784.1054
WWW.NESSCAMPBELL.COM

Rated Lifting Capacities in Pounds

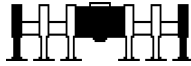

Full

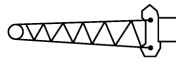

92ft Hydraulic Offset Fly



80,000 lbs



Radius (ft)	Boom Length (ft)								
	Fly Offset								
	167.1			183.6			200.1		
	2°-15°	15°-30°	30°-45°	2°-15°	15°-30°	30°-45°	2°-15°	15°-30°	30°-45°
45	10,400								
50	10,400			9,600					
55	10,300	10,300		9,600			8,200		
60	10,300	10,300		9,500	9,500		8,200		
65	10,300	10,300		9,500	9,500		8,100	8,100	
70	10,300	10,300		9,500	9,500		8,100	8,100	
75	10,300	10,200	10,200	9,500	9,500		8,100	8,100	
80	10,300	10,200	10,200	9,500	9,400	9,400	8,100	8,100	
85	10,300	10,200	9,600	9,500	9,400	9,400	8,100	8,000	8,000
90	10,300	10,200	9,400	9,500	9,400	9,200	8,100	8,000	8,000
95	10,300	10,100	9,200	9,500	9,400	9,200	8,100	8,000	7,800
100	10,300	9,800	9,000	9,500	9,400	9,100	8,100	8,000	7,800
105	10,300	9,500	8,800	9,500	9,400	9,000	8,100	8,000	7,800
110	10,300	9,300	8,600	9,500	9,400	8,800	8,100	8,000	7,800
115	10,100	9,100	8,400	9,500	9,300	8,600	8,100	8,000	7,800
120	9,800	8,900	8,300	9,500	9,100	8,400	8,100	8,000	7,800
125	9,600	8,700	8,100	9,500	8,900	8,300	8,100	8,000	7,800
130	9,300	8,500	7,900	9,500	8,700	8,100	8,100	8,000	7,800
135	9,100	8,300	7,700	9,400	8,500	8,000	8,100	8,000	7,800
140	8,800	8,100	7,600	9,200	8,300	7,800	8,100	8,000	7,800
145	8,600	7,900	7,400	9,000	8,200	7,600	8,100	8,000	7,800
150	8,400	7,700	7,200	8,800	8,000	7,500	8,100	8,000	7,700
155	8,200	7,500	7,100	8,600	7,800	7,300	8,100	8,000	7,500
160	7,800	7,300	7,000	8,300	7,600	7,200	7,500	7,900	7,400
165	7,300	7,100	6,800	7,700	7,400	7,000	6,800	7,600	7,200
170	6,900	7,000	6,700	7,000	7,300	6,900	6,100	6,900	7,100
175	6,500	6,800	6,500	6,400	7,100	6,800	5,500	6,300	7,000
180	6,100	6,400	6,400	5,800	6,500	6,600	4,900	5,600	6,300
185	5,700	6,000	6,200	5,200	5,900	6,500	4,300	5,000	5,700
190	5,300	5,600	5,800	4,700	5,300	5,900	3,800	4,500	5,100
195	5,000	5,200	5,400	4,200	4,800	5,300	3,300	4,000	4,500
200	4,700	4,900	5,100	3,800	4,300	4,800	2,800	3,500	4,000
205	4,300	4,600	4,800	3,300	3,800	4,200	2,400	3,000	3,500
210	3,900	4,300	4,400	2,900	3,400	3,800		2,500	3,000
215	3,500	3,900	4,100	2,500	2,900	3,300		2,100	2,600
220	3,100	3,500	3,700	2,100	2,500	2,800			2,100
225	2,800	3,100	3,200		2,100	2,400			
230	2,500	2,700	2,700						
235	2,100	2,300							
Min Angle	25.5	26.0	21.5	41.5	41.5	42.0	49.5	50.0	51.0
Max Rad. Capacity	237.5	240.0	234.7	221.7	226.7	230.0	210.0	216.3	221.3
	0	0	0	0	0	0	0	0	0

1062100



PORTLAND OFFICE: 503.283.3111
 SEATTLE OFFICE: 206.784.1054
WWW.NESSCAMPBELL.COM

Rated Lifting Capacities in Pounds

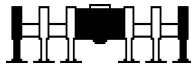

Full

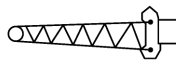

92ft Hydraulic Offset Fly



80,000 lbs



Radius (ft)	Boom Length (ft)											
	Fly Offset											
	44.3			58.9			89.1			120.3		
	2°-15°	15°-30°	30°-45°	2°-15°	15°-30°	30°-45°	2°-15°	15°-30°	30°-45°	2°-15°	15°-30°	30°-45°
20	19,800			19,700								
25	18,100			19,200			18,900					
30	15,500	15,500		16,000	16,000		18,900					
35	14,400	14,400		15,000	15,000		18,300			16,500		
40	13,400	13,400		14,100	14,100		15,100	15,100		16,500		
45	12,600	11,900	11,900	13,300	12,200	12,200	14,300	14,300		16,500		
50	11,800	11,200	11,200	12,500	11,600	11,600	13,600	13,600		14,500	14,500	
55	11,200	10,600	10,200	11,800	11,000	11,000	12,900	11,700	11,700	13,900	13,900	
60	10,500	10,000	9,700	11,200	10,500	10,000	12,300	11,200	11,200	13,300	11,700	11,700
65	10,000	9,500	9,300	10,600	10,000	9,600	11,800	10,700	10,000	12,700	11,300	11,300
70	9,500	9,100	8,800	10,100	9,600	9,200	11,300	10,300	9,700	12,200	10,900	10,000
75	9,000	8,700	8,400	9,600	9,100	8,800	10,800	9,900	9,300	11,800	10,500	9,700
80	8,600	8,300	8,100	9,200	8,700	8,400	10,400	9,600	9,000	11,300	10,200	9,400
85	8,100	7,800	7,700	8,800	8,400	8,100	9,900	9,200	8,700	10,900	9,900	9,200
90	7,700	7,400	7,300	8,400	8,000	7,800	9,600	8,900	8,400	10,500	9,600	8,900
95	7,200	7,100	7,000	8,000	7,700	7,500	9,200	8,600	8,200	10,200	9,300	8,700
100	6,800	6,700	6,600	7,600	7,300	7,200	8,900	8,300	7,900	9,800	9,000	8,400
105	6,400	6,300	6,300	7,200	7,000	6,900	8,500	8,000	7,700	9,500	8,700	8,200
110	6,000	6,000	6,000	6,800	6,600	6,600	8,200	7,700	7,400	9,200	8,500	8,000
115	5,700	5,700	5,700	6,500	6,300	6,300	7,900	7,400	7,200	8,900	8,300	7,800
120	5,400	5,400	5,400	6,200	6,000	6,000	7,600	7,200	7,000	8,600	8,000	7,600
125	5,100	5,100		5,800	5,800	5,800	7,200	6,900	6,700	8,400	7,700	7,400
130				5,600	5,500		6,900	6,600	6,500	8,100	7,500	7,200
135				5,300			6,600	6,400	6,300	7,800	7,300	7,000
140							6,300	6,100	6,100	7,500	7,100	6,800
145							6,100	5,900	5,900	7,300	6,800	6,600
150							5,800	5,700	5,700	7,000	6,600	6,500
155							5,600	5,500	5,500	6,700	6,400	6,300
160							5,400	5,400		6,500	6,200	6,100
165							5,200			6,300	6,000	6,000
170										6,100	5,900	5,800
175										5,900	5,700	5,700
180										5,700	5,500	5,500
185										5,500	5,400	5,400
190										5,300	5,300	
195										5,200		
Min Angle	0.0	0.0	0.0	14.5	28.5	9.5	15.0	26.0	18.5	18.0	26.5	17.0
Max Rad. Capacity	127.9	127.5	124.9	140.0	135.0	126.6	170.0	165.0	156.8	200.0	195.0	188.0
	3,100	3,100	3,400	0	0	0	0	0	0	0	0	0

1062110



PORTLAND OFFICE: 503.283.3111
 SEATTLE OFFICE: 206.784.1054
WWW.NESSCAMPBELL.COM

Rated Lifting Capacities in Pounds

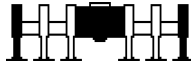

Full

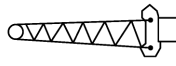

92ft Hydraulic Offset Fly



80,000 lbs



Radius (ft)	Boom Length (ft)								
	Fly Offset								
	152.4			169.0			185.5		
	2°-15°	15°-30°	30°-45°	2°-15°	15°-30°	30°-45°	2°-15°	15°-30°	30°-45°
40	13,500								
45	13,500								
50	13,500			12,500			10,700		
55	13,300	13,300		12,500			10,700		
60	13,300	13,300		12,400	12,400		10,700		
65	13,300	13,300		12,400	12,400		10,600	10,600	
70	13,000	11,400	11,400	12,400	12,400		10,600	10,600	
75	12,600	11,100	11,100	12,400	11,300	11,300	10,600	10,600	
80	12,200	10,700	9,800	12,400	10,900	10,900	10,600	10,400	10,400
85	11,800	10,400	9,500	12,100	10,700	10,700	10,600	10,400	10,400
90	11,400	10,100	9,300	11,800	10,400	9,400	10,600	10,400	10,400
95	11,000	9,800	9,100	11,400	10,100	9,200	10,600	10,300	9,400
100	10,700	9,600	8,800	11,100	9,800	9,000	10,600	10,100	9,200
105	10,300	9,300	8,600	10,700	9,600	8,800	10,600	9,800	9,000
110	10,000	9,100	8,400	10,400	9,300	8,600	10,600	9,600	8,800
115	9,800	8,800	8,300	10,100	9,100	8,500	10,500	9,400	8,600
120	9,500	8,600	8,100	9,900	8,900	8,300	10,200	9,100	8,400
125	9,200	8,400	7,900	9,600	8,700	8,100	10,000	8,900	8,300
130	9,000	8,200	7,700	9,300	8,500	7,900	9,700	8,700	8,100
135	8,700	8,000	7,500	9,100	8,300	7,800	9,500	8,500	8,000
140	8,500	7,800	7,400	8,900	8,100	7,600	9,200	8,400	7,800
145	8,200	7,600	7,200	8,700	7,900	7,400	9,000	8,200	7,600
150	8,000	7,400	7,000	8,400	7,700	7,300	8,800	8,000	7,500
155	7,800	7,200	6,900	8,200	7,500	7,100	8,000	7,800	7,300
160	7,500	7,000	6,700	8,000	7,300	7,000	7,300	7,600	7,200
165	7,300	6,800	6,600	7,500	7,200	6,800	6,600	7,400	7,100
170	7,100	6,600	6,400	6,800	7,000	6,700	5,900	6,700	6,900
175	6,800	6,500	6,300	6,200	6,800	6,600	5,300	6,000	6,800
180	6,400	6,300	6,200	5,600	6,300	6,400	4,700	5,400	6,100
185	6,000	6,100	6,000	5,100	5,700	6,200	4,100	4,800	5,500
190	5,600	5,900	5,900	4,500	5,100	5,600	3,600	4,300	4,900
195	5,100	5,500	5,700	4,100	4,600	5,000	3,100	3,700	4,300
200	4,700	5,100	5,400	3,600	4,100	4,500	2,700	3,200	3,800
205	4,200	4,600	4,800	3,200	3,600	4,000	2,200	2,800	3,200
210	3,800	4,100	4,300	2,700	3,200	3,500		2,300	2,700
215	3,400	3,700	3,700	2,300	2,700	3,000			2,300
220	3,100	3,300			2,300	2,600			
225	2,700	2,900				2,100			
230	2,400								

Min Angle	15.5	15.5	28.0	36.0	36.5	35.5	46.0	47.0	47.0
Max Rad. Capacity	232.8	229.1	220.0	220.0	223.8	226.0	207.5	213.8	218.0
	0	0	0	0	0	0	0	0	0

1062110



PORTLAND OFFICE: 503.283.3111
 SEATTLE OFFICE: 206.784.1054
WWW.NESSCAMPBELL.COM

Rated Lifting Capacities in Pounds

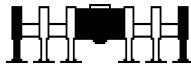

Full

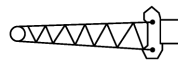

92ft Hydraulic Offset Fly



80,000 lbs



Radius (ft)	Boom Length (ft)											
	Fly Offset											
	44.3			73.5			103.8			119.4		
	2°-15°	15°-30°	30°-45°	2°-15°	15°-30°	30°-45°	2°-15°	15°-30°	30°-45°	2°-15°	15°-30°	30°-45°
20	19,800											
25	18,100			17,300								
30	15,500	15,500		17,300			15,200					
35	14,400	14,400		15,500	15,500		15,200			14,900		
40	13,400	13,400		14,600	14,600		15,200			14,900		
45	12,600	11,900	11,900	13,800	13,800		14,700	14,700		14,900		
50	11,800	11,200	11,200	13,100	11,900	11,900	14,000	14,000		14,500	14,500	
55	11,200	10,600	10,200	12,400	11,400	11,400	13,400	13,400		13,800	13,800	
60	10,500	10,000	9,700	11,800	10,900	10,200	12,800	11,500	11,500	13,300	13,300	
65	10,000	9,500	9,300	11,200	10,400	9,800	12,200	11,000	11,000	12,700	11,300	11,300
70	9,500	9,100	8,800	10,700	10,000	9,400	11,700	10,600	9,800	12,200	10,900	10,900
75	9,000	8,700	8,400	10,200	9,500	9,100	11,300	10,200	9,500	11,700	10,500	9,700
80	8,600	8,300	8,100	9,800	9,200	8,700	10,800	9,900	9,200	11,300	10,200	9,400
85	8,100	7,800	7,700	9,400	8,800	8,400	10,400	9,500	8,900	10,900	9,900	9,200
90	7,700	7,400	7,300	9,000	8,500	8,200	10,000	9,200	8,700	10,500	9,500	8,900
95	7,200	7,100	7,000	8,700	8,200	7,900	9,700	8,900	8,400	10,100	9,300	8,700
100	6,800	6,700	6,600	8,300	7,800	7,600	9,300	8,600	8,200	9,800	9,000	8,400
105	6,400	6,300	6,300	7,900	7,500	7,300	9,000	8,400	8,000	9,500	8,700	8,200
110	6,000	6,000	6,000	7,600	7,200	7,000	8,700	8,100	7,700	9,200	8,500	8,000
115	5,700	5,700	5,700	7,200	6,900	6,800	8,400	7,800	7,500	8,900	8,200	7,800
120	5,400	5,400	5,400	6,900	6,600	6,500	8,100	7,600	7,300	8,600	8,000	7,600
125	5,100	5,100		6,500	6,300	6,300	7,800	7,300	7,100	8,300	7,700	7,400
130				6,200	6,100	6,100	7,500	7,100	6,900	8,000	7,500	7,200
135				6,000	5,800	5,800	7,200	6,800	6,700	7,800	7,300	7,000
140				5,700	5,600	5,600	6,900	6,600	6,400	7,500	7,100	6,800
145				5,500	5,400		6,700	6,400	6,300	7,200	6,800	6,600
150				5,200			6,400	6,200	6,100	7,000	6,600	6,400
155							6,200	6,000	5,900	6,700	6,400	6,300
160							5,900	5,800	5,800	6,500	6,200	6,100
165							5,700	5,600	5,600	6,200	6,000	6,000
170							5,500	5,400	5,400	6,000	5,800	5,800
175							5,300	5,300		5,800	5,700	5,700
180							5,200			5,600	5,500	5,500
185										5,500	5,400	5,400
190										5,300	5,300	
195										5,200		
Min Angle	0.0	0.0	0.0	14.0	26.5	26.0	15.5	25.0	22.5	16.5	25.5	19.5
Max Rad. Capacity	127.9	127.5	124.9	155.0	150.0	141.2	185.0	180.0	171.4	200.0	195.0	187.0
Capacity	3,100	3,100	3,400	0	0	0	0	0	0	0	0	0

1062120



PORTLAND OFFICE: 503.283.3111
 SEATTLE OFFICE: 206.784.1054
WWW.NESSCAMPBELL.COM

Rated Lifting Capacities in Pounds

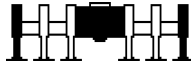

Full

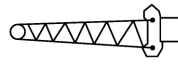

92ft Hydraulic Offset Fly



80,000 lbs



Radius (ft)	Boom Length (ft)								
	Fly Offset								
	135.4			152.0			168.5		
	2°-15°	15°-30°	30°-45°	2°-15°	15°-30°	30°-45°	2°-15°	15°-30°	30°-45°
35	14,900								
40	14,900			14,100					
45	14,900			14,100			12,200		
50	14,900			14,100			12,200		
55	14,200	14,200		14,000	14,000		12,200		
60	13,700	13,700		14,000	14,000		12,100	12,100	
65	13,100	11,500	11,500	13,500	13,500		12,100	12,100	
70	12,600	11,200	11,200	13,000	11,400	11,400	12,100	12,100	
75	12,200	10,800	9,900	12,600	11,100	11,100	12,100	11,300	11,300
80	11,700	10,500	9,600	12,100	10,700	9,800	12,100	10,900	10,900
85	11,300	10,100	9,300	11,700	10,400	9,500	12,100	10,600	9,700
90	10,900	9,800	9,100	11,400	10,100	9,300	11,700	10,400	9,400
95	10,600	9,500	8,900	11,000	9,800	9,100	11,400	10,100	9,200
100	10,200	9,300	8,600	10,700	9,600	8,800	11,100	9,800	9,000
105	9,900	9,000	8,400	10,300	9,300	8,600	10,700	9,600	8,800
110	9,600	8,800	8,200	10,000	9,100	8,400	10,400	9,300	8,600
115	9,300	8,500	8,000	9,700	8,800	8,300	10,100	9,100	8,400
120	9,100	8,300	7,800	9,500	8,600	8,100	9,800	8,900	8,300
125	8,800	8,100	7,600	9,200	8,400	7,900	9,600	8,700	8,100
130	8,500	7,900	7,400	9,000	8,200	7,700	9,300	8,500	7,900
135	8,300	7,600	7,300	8,700	8,000	7,500	9,100	8,300	7,800
140	8,000	7,400	7,100	8,500	7,800	7,300	8,900	8,100	7,600
145	7,800	7,200	6,900	8,200	7,600	7,200	8,600	7,900	7,400
150	7,500	7,000	6,800	8,000	7,400	7,000	8,400	7,700	7,300
155	7,300	6,800	6,600	7,700	7,200	6,900	8,200	7,500	7,100
160	7,000	6,600	6,400	7,500	7,000	6,700	8,000	7,300	7,000
165	6,800	6,400	6,300	7,300	6,800	6,600	7,600	7,200	6,800
170	6,500	6,200	6,100	7,100	6,600	6,400	6,900	7,000	6,700
175	6,300	6,100	6,000	6,800	6,400	6,300	6,300	6,800	6,500
180	6,100	5,900	5,900	6,600	6,300	6,100	5,700	6,300	6,400
185	5,900	5,700	5,700	6,200	6,100	6,000	5,100	5,700	6,300
190	5,800	5,600	5,600	5,700	6,000	5,900	4,600	5,200	5,700
195	5,600	5,500	5,500	5,200	5,600	5,800	4,100	4,600	5,100
200	5,400	5,400	5,400	4,700	5,100	5,400	3,600	4,100	4,500
205	5,300	5,300		4,300	4,600	4,900	3,200	3,700	4,000
210	5,100			3,900	4,200	4,300	2,800	3,200	3,500
215				3,500	3,700	3,800	2,400	2,800	3,100
220				3,100	3,300			2,400	2,600
225				2,800	2,900				2,100
Min Angle	18.0	26.0	16.5	20.5	12.5	14.0	35.5	35.5	35.5
Max Rad. Capacity	215.0	210.0	203.1	230.0	228.6	219.6	220.0	225.0	226.0
	0	0	0	0	0	0	0	0	0

1062120



PORTLAND OFFICE: 503.283.3111
 SEATTLE OFFICE: 206.784.1054
WWW.NESSCAMPBELL.COM

Rated Lifting Capacities in Pounds

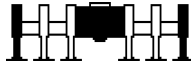

Full

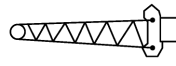

117ft Offset Fly



80,000 lbs



Radius (ft)	Boom Length (ft)											
	Fly Offset											
	44.3				73.5				103.8			
	2°	15°	30°	45°	2°	15°	30°	45°	2°	15°	30°	45°
25	15,800											
30	14,500				14,800							
35	13,300				14,800				13,100			
40	12,300	11,900			13,800				13,100			
45	11,400	11,000			12,900	12,000			13,100			
50	10,600	10,300	10,000		12,100	11,300			13,100			
55	9,900	9,600	9,400		11,300	10,700			12,600	11,500		
60	9,200	9,000	8,800		10,600	10,000	9,500		11,900	10,900		
65	8,600	8,400	8,300	8,200	10,000	9,500	9,000		11,300	10,400		
70	8,100	7,900	7,800	7,800	9,400	9,000	8,600	8,300	10,700	9,900	9,200	
75	7,600	7,500	7,400	7,300	8,900	8,500	8,200	7,900	10,100	9,400	8,800	
80	7,000	6,900	6,900	6,900	8,400	8,100	7,800	7,600	9,600	9,000	8,400	8,000
85	6,600	6,500	6,400	6,400	8,000	7,700	7,400	7,200	9,100	8,500	8,000	7,700
90	6,100	6,100	6,000	6,000	7,500	7,200	7,000	6,800	8,700	8,200	7,700	7,400
95	5,600	5,600	5,600	5,700	7,100	6,800	6,600	6,500	8,300	7,800	7,400	7,100
100	5,200	5,200	5,300	5,300	6,700	6,400	6,200	6,100	7,900	7,500	7,000	6,800
105	4,800	4,900	4,900	4,900	6,300	6,100	5,900	5,800	7,500	7,100	6,700	6,500
110	4,500	4,500	4,600	4,600	5,900	5,700	5,600	5,500	7,100	6,700	6,400	6,200
115	4,200	4,200	4,200	4,300	5,500	5,400	5,300	5,200	6,800	6,400	6,100	5,900
120	3,900	3,900	3,900	4,000	5,200	5,000	5,000	4,900	6,400	6,100	5,800	5,700
125	3,600	3,600	3,700	3,700	4,800	4,700	4,700	4,700	6,100	5,800	5,600	5,400
130	3,300	3,400	3,400	3,500	4,500	4,500	4,400	4,400	5,700	5,500	5,300	5,200
135	3,100	3,100	3,200		4,300	4,200	4,200	4,200	5,400	5,200	5,000	4,900
140	2,900	2,900	2,900		4,000	3,900	3,900	3,900	5,100	4,900	4,800	4,700
145	2,600	2,700			3,700	3,700	3,700	3,700	4,800	4,700	4,500	4,500
150	2,500	2,500			3,500	3,500	3,500	3,500	4,600	4,400	4,300	4,300
155					3,300	3,300	3,300	3,300	4,300	4,200	4,100	4,100
160					3,100	3,100	3,100		4,100	4,000	3,900	3,900
165					2,900	2,900	2,900		3,900	3,800	3,700	3,700
170					2,700	2,700	2,700		3,700	3,600	3,500	3,600
175					2,600	2,600			3,500	3,400	3,400	3,400
180									3,300	3,200	3,200	3,200
185									3,100	3,100	3,100	
190									3,000	2,900	2,900	
195									2,800	2,800	2,800	
200									2,700	2,600	2,700	
205									2,500	2,500		
Min Angle	0.0	0.0	0.0	0.0	13.5	16.0	24.0	29.5	15.0	17.0	23.5	27.5
Max Rad. Capacity	152.9	152.4	149.4	144.0	180.0	180.0	175.0	166.2	210.0	210.0	205.0	196.4
	2,400	2,400	2,500	2,700	0	0	0	0	0	0	0	0

1061130



PORTLAND OFFICE: 503.283.3111
 SEATTLE OFFICE: 206.784.1054
WWW.NESSCAMPBELL.COM

Rated Lifting Capacities in Pounds

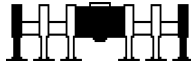

Full

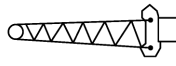

117ft Offset Fly



80,000 lbs



Radius (ft)	Boom Length (ft)											
	Fly Offset											
	134.9				167.1				183.6			
	2°	15°	30°	45°	2°	15°	30°	45°	2°	15°	30°	45°
45	11,000											
50	11,000				8,600							
55	11,000				8,600							
60	11,000				8,600				7,900			
65	11,000	10,900			8,600				7,900			
70	11,000	10,600			8,600	8,500			7,900			
75	11,000	10,200			8,600	8,500			7,900	7,800		
80	10,700	9,700	8,900		8,600	8,500			7,900	7,800		
85	10,200	9,300	8,600		8,600	8,500			7,900	7,800		
90	9,800	8,900	8,300	7,800	8,600	8,500	8,400		7,900	7,800		
95	9,300	8,600	8,000	7,500	8,600	8,500	8,400		7,900	7,800	7,700	
100	8,900	8,200	7,700	7,300	8,600	8,500	8,200	7,600	7,900	7,800	7,700	
105	8,600	7,900	7,400	7,000	8,600	8,500	7,900	7,400	7,900	7,800	7,700	7,500
110	8,200	7,600	7,100	6,700	8,600	8,300	7,600	7,200	7,900	7,800	7,700	7,400
115	7,900	7,300	6,800	6,500	8,600	8,000	7,400	6,900	7,900	7,800	7,600	7,200
120	7,500	7,000	6,500	6,200	8,500	7,800	7,100	6,700	7,900	7,800	7,400	6,900
125	7,200	6,700	6,300	6,000	8,200	7,500	6,900	6,500	7,900	7,800	7,200	6,700
130	6,900	6,400	6,000	5,800	7,900	7,200	6,600	6,300	7,900	7,600	6,900	6,500
135	6,600	6,100	5,800	5,600	7,600	6,900	6,400	6,100	7,900	7,300	6,700	6,300
140	6,300	5,900	5,500	5,400	7,300	6,700	6,200	5,900	7,700	7,000	6,500	6,100
145	6,000	5,600	5,300	5,100	7,000	6,400	6,000	5,700	7,400	6,800	6,200	5,900
150	5,700	5,300	5,100	4,900	6,700	6,200	5,700	5,500	7,100	6,500	6,000	5,700
155	5,400	5,100	4,900	4,700	6,400	5,900	5,500	5,300	6,900	6,300	5,800	5,600
160	5,100	4,900	4,700	4,500	6,200	5,700	5,300	5,100	6,600	6,100	5,600	5,400
165	4,900	4,600	4,500	4,400	5,900	5,500	5,100	4,900	6,400	5,900	5,400	5,200
170	4,600	4,400	4,300	4,200	5,600	5,200	4,900	4,800	6,100	5,600	5,200	5,000
175	4,400	4,200	4,100	4,000	5,400	5,000	4,700	4,600	5,900	5,400	5,100	4,900
180	4,200	4,000	3,900	3,900	5,100	4,800	4,600	4,400	5,600	5,200	4,900	4,700
185	4,000	3,900	3,800	3,700	4,800	4,600	4,400	4,300	5,000	5,000	4,700	4,600
190	3,800	3,700	3,600	3,600	4,500	4,400	4,200	4,100	4,500	4,800	4,500	4,400
195	3,700	3,500	3,500	3,500	4,100	4,300	4,100	4,000	4,000	4,600	4,400	4,300
200	3,500	3,400	3,300	3,300	3,800	4,100	3,900	3,900	3,500	4,200	4,200	4,100
205	3,300	3,200	3,200	3,200	3,500	3,800	3,800	3,700	3,100	3,700	4,100	4,000
210	3,200	3,100	3,100		3,200	3,500	3,700	3,600	2,700	3,200	3,700	3,900
215	3,000	3,000	2,900		2,900	3,200	3,400	3,500	2,300	2,800	3,300	3,500
220	2,900	2,800	2,800		2,700	2,900	3,100	3,200		2,400	2,800	3,000
225	2,700	2,700	2,700		2,400	2,600	2,800	2,900			2,400	2,600
230	2,500	2,600	2,600		2,200	2,400	2,500	2,600				2,100
235	2,400	2,400				2,100	2,300	2,300				
Min Angle	18.0	20.0	25.0	26.0	41.0	42.0	42.0	41.5	50.0	50.5	51.0	51.0
Max Rad. Capacity	240.0	240.0	235.0	227.6	233.3	236.7	240.0	240.0	218.8	225.0	230.0	231.3
	0	0	0	0	0	0	0	0	0	0	0	0

1061130



PORTLAND OFFICE: 503.283.3111
 SEATTLE OFFICE: 206.784.1054
WWW.NESSCAMPBELL.COM

Rated Lifting Capacities in Pounds

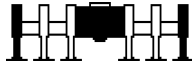

Full

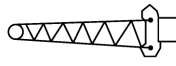

117ft Offset Fly



80,000 lbs



Radius (ft)	Boom Length (ft)			
	Fly Offset			
	200.1			
	2°	15°	30°	45°
60	6,700			
65	6,700			
70	6,700			
75	6,700			
80	6,700	6,600		
85	6,700	6,600		
90	6,700	6,600		
95	6,700	6,600	6,400	
100	6,700	6,600	6,400	
105	6,700	6,600	6,400	
110	6,700	6,600	6,400	6,300
115	6,700	6,600	6,400	6,300
120	6,700	6,600	6,400	6,300
125	6,700	6,600	6,400	6,300
130	6,700	6,600	6,400	6,300
135	6,700	6,600	6,400	6,300
140	6,700	6,600	6,400	6,300
145	6,700	6,600	6,400	6,100
150	6,700	6,600	6,300	5,900
155	6,700	6,600	6,100	5,800
160	6,700	6,400	5,900	5,600
165	6,600	6,200	5,700	5,400
170	5,900	6,000	5,500	5,300
175	5,300	5,800	5,400	5,100
180	4,700	5,500	5,200	4,900
185	4,100	4,900	5,000	4,800
190	3,600	4,400	4,800	4,600
195	3,100	3,800	4,500	4,500
200	2,700	3,300	4,000	4,400
205	2,200	2,900	3,500	3,800
210		2,400	3,000	3,300
215			2,500	2,800
220			2,100	2,400
Min Angle	56.5	57.0	57.5	57.5
Max Rad.	207.5	215.0	221.0	224.0
Capacity	0	0	0	0

1061130



PORTLAND OFFICE: 503.283.3111
 SEATTLE OFFICE: 206.784.1054
WWW.NESSCAMPBELL.COM

Rated Lifting Capacities in Pounds

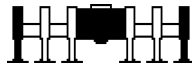

Full

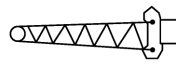

117ft Offset Fly



80,000 lbs



Radius (ft)	Boom Length (ft)											
	Fly Offset											
	44.3				58.9				89.1			
	2°	15°	30°	45°	2°	15°	30°	45°	2°	15°	30°	45°
25	15,800				16,400							
30	14,500				15,300							
35	13,300				14,100				15,600			
40	12,300	11,900			13,100	12,400			14,500			
45	11,400	11,000			12,200	11,600			13,600			
50	10,600	10,300	10,000		11,400	10,800			12,800	11,800		
55	9,900	9,600	9,400		10,600	10,200	9,800		12,000	11,100		
60	9,200	9,000	8,800		10,000	9,600	9,200		11,300	10,500		
65	8,600	8,400	8,300	8,200	9,400	9,000	8,700	8,500	10,700	10,000	9,400	
70	8,100	7,900	7,800	7,800	8,800	8,500	8,200	8,100	10,100	9,500	8,900	
75	7,600	7,500	7,400	7,300	8,300	8,000	7,800	7,700	9,600	9,000	8,500	8,200
80	7,000	6,900	6,900	6,900	7,800	7,600	7,400	7,300	9,100	8,500	8,100	7,800
85	6,600	6,500	6,400	6,400	7,300	7,100	6,900	6,900	8,600	8,100	7,700	7,500
90	6,100	6,100	6,000	6,000	6,800	6,700	6,500	6,500	8,200	7,800	7,400	7,200
95	5,600	5,600	5,600	5,700	6,400	6,300	6,200	6,100	7,800	7,400	7,000	6,800
100	5,200	5,200	5,300	5,300	6,000	5,900	5,800	5,800	7,300	7,000	6,700	6,500
105	4,800	4,900	4,900	4,900	5,600	5,500	5,400	5,400	6,900	6,600	6,300	6,200
110	4,500	4,500	4,600	4,600	5,200	5,100	5,100	5,100	6,600	6,300	6,000	5,900
115	4,200	4,200	4,200	4,300	4,800	4,800	4,800	4,800	6,200	6,000	5,700	5,600
120	3,900	3,900	3,900	4,000	4,500	4,500	4,500	4,500	5,800	5,600	5,400	5,300
125	3,600	3,600	3,700	3,700	4,200	4,200	4,200	4,200	5,500	5,300	5,200	5,100
130	3,300	3,400	3,400	3,500	3,900	3,900	3,900	4,000	5,200	5,000	4,900	4,800
135	3,100	3,100	3,200		3,700	3,700	3,700	3,700	4,900	4,700	4,600	4,600
140	2,900	2,900	2,900		3,400	3,400	3,500	3,500	4,600	4,500	4,400	4,400
145	2,600	2,700			3,200	3,200	3,200		4,300	4,200	4,200	4,100
150	2,500	2,500			3,000	3,000	3,000		4,100	4,000	3,900	3,900
155					2,800	2,800	2,800		3,800	3,800	3,700	3,700
160					2,600	2,600			3,600	3,600	3,500	3,500
165									3,400	3,400	3,400	3,400
170									3,200	3,200	3,200	
175									3,000	3,000	3,000	
180									2,900	2,900	2,900	
185									2,700	2,700	2,700	
190									2,600	2,600		
Min Angle	0.0	0.0	0.0	0.0	14.0	17.0	25.5	30.0	14.5	17.0	24.0	27.0
Max Rad. Capacity	152.9	152.4	149.4	144.0	165.0	165.0	160.0	151.6	195.0	195.0	190.0	181.8
	2,400	2,400	2,500	2,700	0	0	0	0	0	0	0	0

1061140



PORTLAND OFFICE: 503.283.3111
 SEATTLE OFFICE: 206.784.1054
WWW.NESSCAMPBELL.COM

Rated Lifting Capacities in Pounds

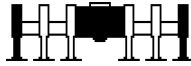

Full

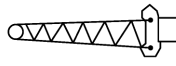

117ft Offset Fly



80,000 lbs



Radius (ft)	Boom Length (ft)											
	Fly Offset											
	120.3				152.4				169.0			
	2°	15°	30°	45°	2°	15°	30°	45°	2°	15°	30°	45°
40	14,400											
45	14,400											
50	14,000				11,500							
55	13,200				11,500				10,600			
60	12,500	11,300			11,500				10,600			
65	11,900	10,800			11,500	11,400			10,600			
70	11,300	10,300	9,500		11,500	11,000			10,600			
75	10,700	9,800	9,100		11,500	10,600			10,600	10,500		
80	10,200	9,400	8,700	8,200	11,300	10,100	9,200		10,600	10,500		
85	9,700	9,000	8,300	7,900	10,800	9,700	8,900		10,600	10,100		
90	9,300	8,600	8,000	7,600	10,300	9,300	8,500	8,000	10,600	9,700	8,800	
95	8,900	8,200	7,700	7,400	9,900	9,000	8,200	7,700	10,400	9,300	8,500	
100	8,500	7,900	7,400	7,100	9,500	8,600	8,000	7,500	9,900	9,000	8,200	7,700
105	8,100	7,600	7,100	6,800	9,100	8,300	7,700	7,300	9,600	8,700	7,900	7,400
110	7,800	7,200	6,800	6,500	8,700	8,000	7,400	7,000	9,200	8,400	7,700	7,200
115	7,400	6,900	6,500	6,200	8,400	7,700	7,100	6,700	8,900	8,100	7,400	7,000
120	7,000	6,600	6,200	6,000	8,100	7,400	6,900	6,500	8,500	7,800	7,200	6,700
125	6,700	6,300	6,000	5,800	7,800	7,100	6,600	6,300	8,200	7,500	6,900	6,500
130	6,400	6,000	5,700	5,500	7,400	6,800	6,400	6,100	7,900	7,200	6,700	6,300
135	6,100	5,700	5,400	5,300	7,100	6,600	6,100	5,900	7,600	7,000	6,400	6,100
140	5,700	5,400	5,200	5,100	6,800	6,300	5,900	5,700	7,300	6,700	6,200	5,900
145	5,400	5,200	5,000	4,800	6,500	6,100	5,700	5,500	7,000	6,400	6,000	5,700
150	5,200	4,900	4,700	4,600	6,300	5,800	5,500	5,300	6,700	6,200	5,800	5,500
155	4,900	4,700	4,500	4,400	6,000	5,600	5,200	5,100	6,500	6,000	5,600	5,300
160	4,700	4,500	4,300	4,300	5,700	5,300	5,000	4,900	6,200	5,700	5,400	5,100
165	4,400	4,200	4,100	4,100	5,400	5,100	4,800	4,700	5,900	5,500	5,200	5,000
170	4,200	4,000	3,900	3,900	5,200	4,900	4,600	4,500	5,700	5,300	5,000	4,800
175	4,000	3,900	3,800	3,700	4,900	4,700	4,500	4,400	5,400	5,100	4,800	4,600
180	3,800	3,700	3,600	3,600	4,700	4,500	4,300	4,200	5,200	4,900	4,600	4,500
185	3,600	3,500	3,400	3,400	4,500	4,300	4,100	4,000	5,000	4,700	4,400	4,300
190	3,400	3,300	3,300	3,300	4,300	4,100	4,000	3,900	4,400	4,500	4,300	4,200
195	3,300	3,200	3,200	3,200	4,100	3,900	3,800	3,800	3,900	4,300	4,100	4,000
200	3,100	3,000	3,000		3,900	3,800	3,700	3,600	3,500	4,000	4,000	3,900
205	2,900	2,900	2,900		3,800	3,600	3,500	3,500	3,000	3,600	3,800	3,800
210	2,800	2,800	2,800		3,500	3,500	3,400	3,400	2,600	3,100	3,600	3,700
215	2,700	2,600	2,700		3,200	3,300	3,300	3,300	2,200	2,700	3,100	3,300
220	2,500	2,500			2,900	3,200	3,100	3,200		2,300	2,700	2,800
225					2,500	2,800	3,000				2,200	2,300
230					2,200	2,500	2,700					
235						2,100	2,300					
Min Angle	17.5	19.5	25.0	24.5	34.5	34.5	34.5	34.0	45.5	46.5	46.5	46.5
Max Rad.	225.0	225.0	220.0	213.0	232.5	236.7	238.8	237.0	217.5	223.8	227.5	228.8
Capacity	0	0	0	0	0	0	0	0	0	0	0	0

1061140



PORTLAND OFFICE: 503.283.3111
 SEATTLE OFFICE: 206.784.1054
WWW.NESSCAMPBELL.COM

Rated Lifting Capacities in Pounds

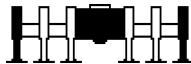

Full

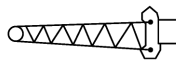

117ft Offset Fly



80,000 lbs



Radius (ft)	Boom Length (ft)			
	Fly Offset			
	185.5			
	2°	15°	30°	45°
60	9,000			
65	9,000			
70	9,000			
75	9,000			
80	9,000	9,000		
85	9,000	9,000		
90	9,000	9,000		
95	9,000	9,000	8,700	
100	9,000	9,000	8,400	
105	9,000	9,000	8,200	7,600
110	9,000	8,700	7,900	7,400
115	9,000	8,400	7,700	7,200
120	9,000	8,100	7,400	6,900
125	8,600	7,900	7,200	6,700
130	8,300	7,600	6,900	6,500
135	8,100	7,300	6,700	6,300
140	7,800	7,100	6,500	6,100
145	7,500	6,800	6,300	5,900
150	7,200	6,600	6,100	5,800
155	6,900	6,300	5,900	5,600
160	6,700	6,100	5,700	5,400
165	6,400	5,900	5,500	5,200
170	5,800	5,700	5,300	5,100
175	5,200	5,500	5,100	4,900
180	4,600	5,200	4,900	4,700
185	4,000	4,800	4,700	4,600
190	3,500	4,200	4,600	4,400
195	3,000	3,700	4,300	4,300
200	2,500	3,200	3,800	4,200
205	2,100	2,700	3,300	3,600
210		2,300	2,800	3,100
215			2,300	2,600
220				2,100
Min Angle	53.0	53.5	54.5	54.0
Max Rad.	206.3	213.0	218.8	221.3
Capacity	0	0	0	0

1061140



PORTLAND OFFICE: 503.283.3111
 SEATTLE OFFICE: 206.784.1054
WWW.NESSCAMPBELL.COM

Rated Lifting Capacities in Pounds

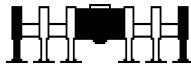

Full

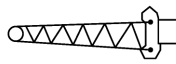

117ft Offset Fly



80,000 lbs



Radius (ft)	Boom Length (ft)											
	Fly Offset											
	44.3				73.5				103.8			
	2°	15°	30°	45°	2°	15°	30°	45°	2°	15°	30°	45°
25	15,800											
30	14,500				14,800							
35	13,300				14,800				13,100			
40	12,300	11,900			13,800				13,100			
45	11,400	11,000			12,900	12,000			13,100			
50	10,600	10,300	10,000		12,100	11,300			13,100			
55	9,900	9,600	9,400		11,300	10,700			12,600	11,500		
60	9,200	9,000	8,800		10,600	10,000	9,500		11,900	10,900		
65	8,600	8,400	8,300	8,200	10,000	9,500	9,000		11,300	10,400		
70	8,100	7,900	7,800	7,800	9,400	9,000	8,600	8,300	10,700	9,900	9,200	
75	7,600	7,500	7,400	7,300	8,900	8,500	8,200	7,900	10,100	9,400	8,800	
80	7,000	6,900	6,900	6,900	8,400	8,100	7,800	7,600	9,600	9,000	8,400	8,000
85	6,600	6,500	6,400	6,400	8,000	7,700	7,400	7,200	9,100	8,500	8,000	7,700
90	6,100	6,100	6,000	6,000	7,500	7,200	7,000	6,800	8,700	8,200	7,700	7,400
95	5,600	5,600	5,600	5,700	7,100	6,800	6,600	6,500	8,300	7,800	7,400	7,100
100	5,200	5,200	5,300	5,300	6,700	6,400	6,200	6,100	7,900	7,500	7,000	6,800
105	4,800	4,900	4,900	4,900	6,300	6,100	5,900	5,800	7,500	7,100	6,700	6,500
110	4,500	4,500	4,600	4,600	5,900	5,700	5,600	5,500	7,100	6,700	6,400	6,200
115	4,200	4,200	4,200	4,300	5,500	5,400	5,300	5,200	6,800	6,400	6,100	5,900
120	3,900	3,900	3,900	4,000	5,200	5,000	5,000	4,900	6,400	6,100	5,800	5,700
125	3,600	3,600	3,700	3,700	4,800	4,700	4,700	4,700	6,100	5,800	5,600	5,400
130	3,300	3,400	3,400	3,500	4,500	4,500	4,400	4,400	5,700	5,500	5,300	5,200
135	3,100	3,100	3,200		4,300	4,200	4,200	4,200	5,400	5,200	5,000	4,900
140	2,900	2,900	2,900		4,000	3,900	3,900	3,900	5,100	4,900	4,800	4,700
145	2,600	2,700			3,700	3,700	3,700	3,700	4,800	4,700	4,500	4,500
150	2,500	2,500			3,500	3,500	3,500	3,500	4,600	4,400	4,300	4,300
155					3,300	3,300	3,300	3,300	4,300	4,200	4,100	4,100
160					3,100	3,100	3,100		4,100	4,000	3,900	3,900
165					2,900	2,900	2,900		3,900	3,800	3,700	3,700
170					2,700	2,700	2,700		3,700	3,600	3,500	3,600
175					2,600	2,600			3,500	3,400	3,400	3,400
180									3,300	3,200	3,200	3,200
185									3,100	3,100	3,100	
190									3,000	2,900	2,900	
195									2,800	2,800	2,800	
200									2,700	2,600	2,700	
205									2,500	2,500		
Min Angle	0.0	0.0	0.0	0.0	13.5	16.0	24.0	29.5	15.0	17.0	23.5	27.5
Max Rad. Capacity	152.9	152.4	149.4	144.0	180.0	180.0	175.0	166.2	210.0	210.0	205.0	196.4
	2,400	2,400	2,500	2,700	0	0	0	0	0	0	0	0

1061150



PORTLAND OFFICE: 503.283.3111
 SEATTLE OFFICE: 206.784.1054
WWW.NESSCAMPBELL.COM

Rated Lifting Capacities in Pounds

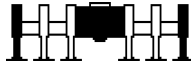

Full

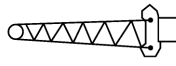

117ft Offset Fly



80,000 lbs



Radius (ft)	Boom Length (ft)											
	Fly Offset											
	119.4				135.4				152.0			
	2°	15°	30°	45°	2°	15°	30°	45°	2°	15°	30°	45°
40	12,800											
45	12,800				12,700							
50	12,800				12,700				11,900			
55	12,800				12,700				11,900			
60	12,500	11,300			12,700	11,700			11,900			
65	11,800	10,800			12,400	11,100			11,900	11,500		
70	11,200	10,300			11,800	10,700			11,900	11,000		
75	10,700	9,800	9,100		11,200	10,200	9,300		11,800	10,500		
80	10,200	9,400	8,700		10,700	9,800	8,900		11,200	10,100	9,200	
85	9,700	9,000	8,300	7,900	10,200	9,300	8,600	8,100	10,800	9,700	8,900	
90	9,300	8,600	8,000	7,600	9,800	9,000	8,300	7,800	10,300	9,300	8,500	8,000
95	8,800	8,200	7,700	7,300	9,400	8,600	8,000	7,500	9,900	9,000	8,200	7,700
100	8,400	7,900	7,400	7,000	9,000	8,300	7,700	7,300	9,500	8,600	8,000	7,500
105	8,100	7,600	7,100	6,800	8,600	7,900	7,400	7,000	9,100	8,300	7,700	7,300
110	7,700	7,200	6,800	6,500	8,200	7,600	7,100	6,700	8,700	8,000	7,400	7,000
115	7,400	6,900	6,500	6,200	7,900	7,300	6,800	6,500	8,400	7,700	7,100	6,700
120	7,000	6,600	6,200	6,000	7,600	7,000	6,500	6,200	8,100	7,400	6,900	6,500
125	6,700	6,300	5,900	5,700	7,200	6,700	6,300	6,000	7,800	7,100	6,600	6,300
130	6,300	6,000	5,700	5,500	6,900	6,400	6,000	5,800	7,400	6,800	6,400	6,100
135	6,000	5,700	5,400	5,300	6,600	6,100	5,800	5,600	7,100	6,600	6,100	5,800
140	5,700	5,400	5,200	5,000	6,300	5,900	5,600	5,400	6,800	6,300	5,900	5,600
145	5,400	5,100	4,900	4,800	6,000	5,600	5,300	5,100	6,500	6,000	5,700	5,400
150	5,100	4,900	4,700	4,600	5,700	5,400	5,100	4,900	6,200	5,800	5,400	5,200
155	4,900	4,700	4,500	4,400	5,400	5,100	4,900	4,700	6,000	5,500	5,200	5,000
160	4,600	4,400	4,300	4,200	5,100	4,900	4,700	4,600	5,700	5,300	5,000	4,900
165	4,400	4,200	4,100	4,100	4,900	4,700	4,500	4,400	5,400	5,100	4,800	4,700
170	4,200	4,000	3,900	3,900	4,700	4,400	4,300	4,200	5,200	4,900	4,600	4,500
175	4,000	3,800	3,700	3,700	4,400	4,200	4,100	4,000	4,900	4,700	4,400	4,300
180	3,800	3,700	3,600	3,600	4,200	4,100	3,900	3,900	4,700	4,500	4,300	4,200
185	3,600	3,500	3,400	3,400	4,000	3,900	3,800	3,700	4,500	4,300	4,100	4,000
190	3,400	3,300	3,300	3,300	3,800	3,700	3,600	3,600	4,300	4,100	3,900	3,900
195	3,200	3,200	3,100	3,200	3,700	3,500	3,500	3,500	4,100	3,900	3,800	3,800
200	3,100	3,000	3,000		3,500	3,400	3,300	3,300	3,900	3,800	3,700	3,600
205	2,900	2,900	2,900		3,300	3,200	3,200	3,200	3,800	3,600	3,500	3,500
210	2,800	2,700	2,700		3,200	3,100	3,100		3,600	3,500	3,400	3,400
215	2,600	2,600	2,600		3,000	3,000	2,900		3,300	3,300	3,300	3,300
220	2,500	2,500			2,900	2,800	2,800		2,900	3,200	3,100	3,200
225					2,800	2,700	2,700		2,600	2,900	3,000	
230					2,600	2,600	2,600		2,200	2,500	2,700	
235					2,500	2,500				2,200	2,300	
Min Angle	16.5	18.5	24.0	26.0	18.0	20.0	25.0	24.0	33.5	33.5	34.0	33.0
Max Rad.	225.0	225.0	220.0	212.0	240.0	240.0	235.0	228.1	233.3	237.5	238.8	237.5
Capacity	0	0	0	0	0	0	0	0	0	0	0	0

1061150



PORTLAND OFFICE: 503.283.3111
 SEATTLE OFFICE: 206.784.1054
WWW.NESSCAMPBELL.COM

Rated Lifting Capacities in Pounds

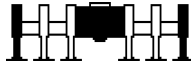

Full

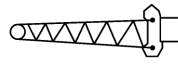

117ft Offset Fly



80,000 lbs



Radius (ft)	Boom Length (ft)			
	Fly Offset			
	168.5			
	2°	15°	30°	45°
50	10,200			
55	10,200			
60	10,200			
65	10,200			
70	10,200	10,100		
75	10,200	10,100		
80	10,200	10,100		
85	10,200	10,100	9,100	
90	10,200	9,700	8,800	
95	10,200	9,300	8,500	7,900
100	9,900	9,000	8,200	7,700
105	9,500	8,700	7,900	7,400
110	9,200	8,300	7,700	7,200
115	8,800	8,100	7,400	7,000
120	8,500	7,800	7,200	6,700
125	8,200	7,500	6,900	6,500
130	7,900	7,200	6,700	6,300
135	7,600	7,000	6,400	6,100
140	7,300	6,700	6,200	5,900
145	7,000	6,400	6,000	5,700
150	6,700	6,200	5,800	5,500
155	6,500	6,000	5,600	5,300
160	6,200	5,700	5,400	5,100
165	5,900	5,500	5,200	5,000
170	5,700	5,300	5,000	4,800
175	5,400	5,100	4,800	4,600
180	5,200	4,900	4,600	4,500
185	5,000	4,700	4,400	4,300
190	4,500	4,500	4,300	4,200
195	4,000	4,300	4,100	4,000
200	3,500	4,100	4,000	3,900
205	3,100	3,600	3,800	3,800
210	2,600	3,200	3,600	3,600
215	2,200	2,700	3,100	3,300
220		2,300	2,700	2,800
225			2,300	2,400
Min Angle	45.5	46.0	46.0	46.0
Max Rad. Capacity	218.3	223.8	228.8	229.0
	0	0	0	0

1061150



PORTLAND OFFICE: 503.283.3111
 SEATTLE OFFICE: 206.784.1054
WWW.NESSCAMPBELL.COM

Rated Lifting Capacities in Pounds

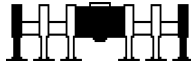

Full

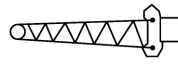

117ft Hydraulic Offset Fly



80,000 lbs



Radius (ft)	Boom Length (ft)											
	Fly Offset											
	44.3			73.5			103.8			134.9		
	2°-15°	15°-30°	30°-45°	2°-15°	15°-30°	30°-45°	2°-15°	15°-30°	30°-45°	2°-15°	15°-30°	30°-45°
25	15,800											
30	14,500			14,800								
35	12,800	12,800		14,800			13,100					
40	11,900	11,900		12,900	12,900		13,100					
45	11,000	11,000		12,000	12,000		13,100			11,000		
50	10,300	10,000	10,000	11,300	11,300		12,200	12,200		11,000		
55	9,600	9,400	9,400	10,700	10,100	10,100	11,500	11,500		11,000		
60	9,000	8,800	8,700	10,000	9,500	9,500	10,900	10,900		10,900	10,900	
65	8,400	8,300	8,200	9,500	9,000	8,700	10,400	9,600	9,600	10,900	10,900	
70	7,900	7,800	7,800	9,000	8,600	8,300	9,900	9,200	9,200	10,600	10,600	
75	7,500	7,400	7,300	8,500	8,200	7,900	9,400	8,800	8,400	10,200	9,300	9,300
80	6,900	6,900	6,900	8,100	7,800	7,600	9,000	8,400	8,000	9,700	8,900	8,900
85	6,500	6,400	6,400	7,700	7,400	7,200	8,500	8,000	7,700	9,300	8,600	8,100
90	6,100	6,000	6,000	7,200	7,000	6,800	8,200	7,700	7,400	8,900	8,300	7,800
95	5,600	5,600	5,600	6,800	6,600	6,500	7,800	7,400	7,100	8,600	8,000	7,500
100	5,200	5,200	5,300	6,400	6,200	6,100	7,500	7,000	6,800	8,200	7,700	7,300
105	4,800	4,900	4,900	6,100	5,900	5,800	7,100	6,700	6,500	7,900	7,400	7,000
110	4,500	4,500	4,600	5,700	5,600	5,500	6,700	6,400	6,200	7,600	7,100	6,700
115	4,200	4,200	4,200	5,400	5,300	5,200	6,400	6,100	5,900	7,300	6,800	6,500
120	3,900	3,900	3,900	5,000	5,000	4,900	6,100	5,800	5,700	7,000	6,500	6,200
125	3,600	3,600	3,700	4,700	4,700	4,700	5,800	5,600	5,400	6,700	6,300	6,000
130	3,300	3,400	3,400	4,500	4,400	4,400	5,500	5,300	5,200	6,400	6,000	5,800
135	3,100	3,100	3,200	4,200	4,200	4,200	5,200	5,000	4,900	6,100	5,800	5,600
140	2,900	2,900	2,900	3,900	3,900	3,900	4,900	4,800	4,700	5,900	5,500	5,400
145	2,600	2,700		3,700	3,700	3,700	4,700	4,500	4,500	5,600	5,300	5,100
150	2,500	2,500		3,500	3,500	3,500	4,400	4,300	4,300	5,300	5,100	4,900
155				3,300	3,300	3,300	4,200	4,100	4,100	5,100	4,900	4,700
160				3,100	3,100	3,100	4,000	3,900	3,900	4,900	4,700	4,500
165				2,900	2,900	2,900	3,800	3,700	3,700	4,600	4,500	4,400
170				2,700	2,700		3,600	3,500	3,500	4,400	4,300	4,200
175				2,600			3,400	3,400	3,400	4,200	4,100	4,000
180							3,200	3,200	3,200	4,000	3,900	3,900
185							3,100	3,100	3,100	3,900	3,800	3,700
190							2,900	2,900	2,900	3,700	3,600	3,600
195							2,800	2,800	2,800	3,500	3,500	3,500
200							2,600	2,600		3,400	3,300	3,300
205							2,500			3,200	3,200	3,200
210										3,100	3,100	3,100
215										3,000	2,900	2,900
220										2,800	2,800	2,800
225										2,700	2,700	2,700
230										2,500	2,600	
235										2,400		
Min Angle	0.0	0.0	0.0	13.5	24.0	29.5	15.0	23.5	27.5	18.0	25.0	26.0
Max Rad. Capacity	152.9	152.4	149.4	180.0	175.0	166.2	210.0	205.0	196.4	240.0	235.0	227.6
	2,400	2,400	2,500	0	0	0	0	0	0	0	0	0

1062130



PORTLAND OFFICE: 503.283.3111
 SEATTLE OFFICE: 206.784.1054
WWW.NESSCAMPBELL.COM

Rated Lifting Capacities in Pounds

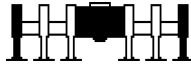

Full

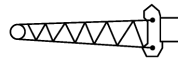

117ft Hydraulic Offset Fly



80,000 lbs



Radius (ft)	Boom Length (ft)								
	Fly Offset								
	167.1			183.6			200.1		
	2°-15°	15°-30°	30°-45°	2°-15°	15°-30°	30°-45°	2°-15°	15°-30°	30°-45°
50	8,600								
55	8,600								
60	8,600			7,900			6,700		
65	8,500	8,500		7,900			6,700		
70	8,500	8,500		7,800	7,800		6,600	6,600	
75	8,500	8,500		7,800	7,800		6,600	6,600	
80	8,500	8,500		7,800	7,800		6,600	6,600	
85	8,500	8,400	8,400	7,800	7,600	7,600	6,600	6,600	
90	8,500	8,400	8,400	7,800	7,600	7,600	6,600	6,600	
95	8,500	8,400	7,900	7,800	7,600	7,600	6,600	6,400	6,400
100	8,500	8,200	7,600	7,800	7,600	7,400	6,600	6,400	6,400
105	8,500	7,900	7,400	7,800	7,600	7,400	6,600	6,400	6,200
110	8,300	7,600	7,200	7,800	7,600	7,400	6,600	6,400	6,200
115	8,000	7,400	6,900	7,800	7,600	7,200	6,600	6,400	6,200
120	7,800	7,100	6,700	7,800	7,400	6,900	6,600	6,400	6,200
125	7,500	6,900	6,500	7,800	7,200	6,700	6,600	6,400	6,200
130	7,200	6,600	6,300	7,600	6,900	6,500	6,600	6,400	6,200
135	6,900	6,400	6,100	7,300	6,700	6,300	6,600	6,400	6,200
140	6,700	6,200	5,900	7,000	6,500	6,100	6,600	6,400	6,200
145	6,400	6,000	5,700	6,800	6,200	5,900	6,600	6,400	6,100
150	6,200	5,700	5,500	6,500	6,000	5,700	6,600	6,300	5,900
155	5,900	5,500	5,300	6,300	5,800	5,600	6,600	6,100	5,800
160	5,700	5,300	5,100	6,100	5,600	5,400	6,400	5,900	5,600
165	5,500	5,100	4,900	5,900	5,400	5,200	6,200	5,700	5,400
170	5,200	4,900	4,800	5,600	5,200	5,000	5,900	5,500	5,300
175	5,000	4,700	4,600	5,400	5,100	4,900	5,300	5,400	5,100
180	4,800	4,600	4,400	5,200	4,900	4,700	4,700	5,200	4,900
185	4,600	4,400	4,300	5,000	4,700	4,600	4,100	4,900	4,800
190	4,400	4,200	4,100	4,500	4,500	4,400	3,600	4,400	4,600
195	4,100	4,100	4,000	4,000	4,400	4,300	3,100	3,800	4,500
200	3,800	3,900	3,900	3,500	4,200	4,100	2,700	3,300	4,000
205	3,500	3,800	3,700	3,100	3,700	4,000	2,200	2,900	3,500
210	3,200	3,500	3,600	2,700	3,200	3,700		2,400	3,000
215	2,900	3,200	3,400	2,300	2,800	3,300			2,500
220	2,700	2,900	3,100		2,400	2,800			2,100
225	2,400	2,600	2,800			2,400			
230	2,200	2,400	2,500						
235		2,100	2,300						
Min Angle	41.0	42.0	41.5	50.0	50.5	51.0	56.5	57.0	57.5
Max Rad.	233.3	236.7	240.0	218.8	225.0	230.0	207.5	215.0	221.0
Capacity	0	0	0	0	0	0	0	0	0

1062130



PORTLAND OFFICE: 503.283.3111
 SEATTLE OFFICE: 206.784.1054
WWW.NESSCAMPBELL.COM

Rated Lifting Capacities in Pounds

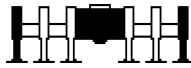

Full

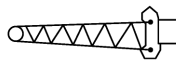

117ft Hydraulic Offset Fly



80,000 lbs



Radius (ft)	Boom Length (ft)											
	Fly Offset											
	44.3			58.9			89.1			120.3		
	2°-15°	15°-30°	30°-45°	2°-15°	15°-30°	30°-45°	2°-15°	15°-30°	30°-45°	2°-15°	15°-30°	30°-45°
25	15,800			16,400								
30	14,500			15,300								
35	12,800	12,800		13,300	13,300		15,600					
40	11,900	11,900		12,400	12,400		14,500			14,400		
45	11,000	11,000		11,600	11,600		12,500	12,500		14,400		
50	10,300	10,000	10,000	10,800	10,400	10,400	11,800	11,800		14,000		
55	9,600	9,400	9,400	10,200	9,800	9,800	11,100	11,100		11,900	11,900	
60	9,000	8,800	8,700	9,600	9,200	9,200	10,500	9,800	9,800	11,300	11,300	
65	8,400	8,300	8,200	9,000	8,700	8,500	10,000	9,400	9,400	10,800	9,900	9,900
70	7,900	7,800	7,800	8,500	8,200	8,100	9,500	8,900	8,500	10,300	9,500	9,500
75	7,500	7,400	7,300	8,000	7,800	7,700	9,000	8,500	8,200	9,800	9,100	9,100
80	6,900	6,900	6,900	7,600	7,400	7,300	8,500	8,100	7,800	9,400	8,700	8,200
85	6,500	6,400	6,400	7,100	6,900	6,900	8,100	7,700	7,500	9,000	8,300	7,900
90	6,100	6,000	6,000	6,700	6,500	6,500	7,800	7,400	7,200	8,600	8,000	7,600
95	5,600	5,600	5,600	6,300	6,200	6,100	7,400	7,000	6,800	8,200	7,700	7,400
100	5,200	5,200	5,300	5,900	5,800	5,800	7,000	6,700	6,500	7,900	7,400	7,100
105	4,800	4,900	4,900	5,500	5,400	5,400	6,600	6,300	6,200	7,600	7,100	6,800
110	4,500	4,500	4,600	5,100	5,100	5,100	6,300	6,000	5,900	7,200	6,800	6,500
115	4,200	4,200	4,200	4,800	4,800	4,800	6,000	5,700	5,600	6,900	6,500	6,200
120	3,900	3,900	3,900	4,500	4,500	4,500	5,600	5,400	5,300	6,600	6,200	6,000
125	3,600	3,600	3,700	4,200	4,200	4,200	5,300	5,200	5,100	6,300	6,000	5,800
130	3,300	3,400	3,400	3,900	3,900	3,900	5,000	4,900	4,800	6,000	5,700	5,500
135	3,100	3,100	3,200	3,700	3,700	3,700	4,700	4,600	4,600	5,700	5,400	5,300
140	2,900	2,900	2,900	3,400	3,400	3,500	4,500	4,400	4,400	5,400	5,200	5,100
145	2,600	2,700		3,200	3,200	3,200	4,200	4,200	4,100	5,200	5,000	4,800
150	2,500	2,500		3,000	3,000	3,000	4,000	3,900	3,900	4,900	4,700	4,600
155				2,800	2,800		3,800	3,700	3,700	4,700	4,500	4,400
160				2,600			3,600	3,500	3,500	4,500	4,300	4,300
165							3,400	3,400	3,400	4,200	4,100	4,100
170							3,200	3,200	3,200	4,000	3,900	3,900
175							3,000	3,000	3,000	3,900	3,800	3,700
180							2,900	2,900	2,900	3,700	3,600	3,600
185							2,700	2,700		3,500	3,400	3,400
190							2,600			3,300	3,300	3,300
195										3,200	3,200	3,200
200										3,000	3,000	3,000
205										2,900	2,900	2,900
210										2,800	2,800	2,800
215										2,600	2,600	
220										2,500		
Min Angle	0.0	0.0	0.0	14.0	25.5	30.0	14.5	24.0	27.0	17.5	25.0	24.5
Max Rad.	152.9	152.4	149.4	165.0	160.0	151.6	195.0	190.0	181.8	225.0	220.0	213.0
Capacity	2,400	2,400	2,500	0	0	0	0	0	0	0	0	0

1062140



PORTLAND OFFICE: 503.283.3111
 SEATTLE OFFICE: 206.784.1054
WWW.NESSCAMPBELL.COM

Rated Lifting Capacities in Pounds

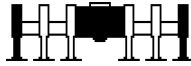

Full

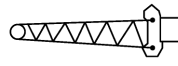

117ft Hydraulic Offset Fly



80,000 lbs



Radius (ft)	Boom Length (ft)								
	Fly Offset								
	152.4			169.0			185.5		
	2°-15°	15°-30°	30°-45°	2°-15°	15°-30°	30°-45°	2°-15°	15°-30°	30°-45°
50	11,500								
55	11,500			10,600					
60	11,500			10,600			9,000		
65	11,400	11,400		10,400	10,400		9,000		
70	11,000	11,000		10,400	10,400		8,900	8,900	
75	10,600	10,600		10,400	10,400		8,900	8,900	
80	10,100	9,200	9,200	10,400	10,400		8,900	8,900	
85	9,700	8,900	8,900	10,100	9,100	9,100	8,900	8,900	
90	9,300	8,500	8,000	9,700	8,800	8,800	8,900	8,700	8,700
95	9,000	8,200	7,700	9,300	8,500	7,900	8,900	8,700	8,700
100	8,600	8,000	7,500	9,000	8,200	7,700	8,900	8,400	7,800
105	8,300	7,700	7,300	8,700	7,900	7,400	8,900	8,200	7,600
110	8,000	7,400	7,000	8,400	7,700	7,200	8,700	7,900	7,400
115	7,700	7,100	6,700	8,100	7,400	7,000	8,400	7,700	7,200
120	7,400	6,900	6,500	7,800	7,200	6,700	8,100	7,400	6,900
125	7,100	6,600	6,300	7,500	6,900	6,500	7,900	7,200	6,700
130	6,800	6,400	6,100	7,200	6,700	6,300	7,600	6,900	6,500
135	6,600	6,100	5,900	7,000	6,400	6,100	7,300	6,700	6,300
140	6,300	5,900	5,700	6,700	6,200	5,900	7,100	6,500	6,100
145	6,100	5,700	5,500	6,400	6,000	5,700	6,800	6,300	5,900
150	5,800	5,500	5,300	6,200	5,800	5,500	6,600	6,100	5,800
155	5,600	5,200	5,100	6,000	5,600	5,300	6,300	5,900	5,600
160	5,300	5,000	4,900	5,700	5,400	5,100	6,100	5,700	5,400
165	5,100	4,800	4,700	5,500	5,200	5,000	5,900	5,500	5,200
170	4,900	4,600	4,500	5,300	5,000	4,800	5,700	5,300	5,100
175	4,700	4,500	4,400	5,100	4,800	4,600	5,200	5,100	4,900
180	4,500	4,300	4,200	4,900	4,600	4,500	4,600	4,900	4,700
185	4,300	4,100	4,000	4,700	4,400	4,300	4,000	4,700	4,600
190	4,100	4,000	3,900	4,400	4,300	4,200	3,500	4,200	4,400
195	3,900	3,800	3,800	3,900	4,100	4,000	3,000	3,700	4,300
200	3,800	3,700	3,600	3,500	4,000	3,900	2,500	3,200	3,800
205	3,600	3,500	3,500	3,000	3,600	3,800	2,100	2,700	3,300
210	3,500	3,400	3,400	2,600	3,100	3,600		2,300	2,800
215	3,200	3,300	3,300	2,200	2,700	3,100			2,300
220	2,900	3,100	3,100		2,300	2,700			
225	2,500	2,800	3,000			2,200			
230	2,200	2,500	2,600						
235		2,100	2,200						
Min Angle	34.5	34.5	34.0	45.5	46.5	46.5	53.0	53.5	54.5
Max Rad.	232.5	236.7	237.0	217.5	223.8	227.5	206.3	213.0	218.8
Capacity	0	0	0	0	0	0	0	0	0

1062140



PORTLAND OFFICE: 503.283.3111
 SEATTLE OFFICE: 206.784.1054
WWW.NESSCAMPBELL.COM

Rated Lifting Capacities in Pounds

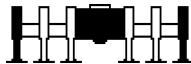

Full

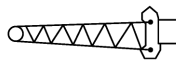

117ft Hydraulic Offset Fly



80,000 lbs



Radius (ft)	Boom Length (ft)											
	Fly Offset											
	44.3			73.5			103.8			119.4		
	2°-15°	15°-30°	30°-45°	2°-15°	15°-30°	30°-45°	2°-15°	15°-30°	30°-45°	2°-15°	15°-30°	30°-45°
25	15,800											
30	14,500			14,800								
35	12,800	12,800		14,800			13,100					
40	11,900	11,900		12,900	12,900		13,100			12,800		
45	11,000	11,000		12,000	12,000		13,100			12,800		
50	10,300	10,000	10,000	11,300	11,300		12,200	12,200		12,800		
55	9,600	9,400	9,400	10,700	10,100	10,100	11,500	11,500		11,900	11,900	
60	9,000	8,800	8,700	10,000	9,500	9,500	10,900	10,900		11,300	11,300	
65	8,400	8,300	8,200	9,500	9,000	8,700	10,400	9,600	9,600	10,800	10,800	
70	7,900	7,800	7,800	9,000	8,600	8,300	9,900	9,200	9,200	10,300	9,500	9,500
75	7,500	7,400	7,300	8,500	8,200	7,900	9,400	8,800	8,400	9,800	9,100	9,100
80	6,900	6,900	6,900	8,100	7,800	7,600	9,000	8,400	8,000	9,400	8,700	8,200
85	6,500	6,400	6,400	7,700	7,400	7,200	8,500	8,000	7,700	9,000	8,300	7,900
90	6,100	6,000	6,000	7,200	7,000	6,800	8,200	7,700	7,400	8,600	8,000	7,600
95	5,600	5,600	5,600	6,800	6,600	6,500	7,800	7,400	7,100	8,200	7,700	7,300
100	5,200	5,200	5,300	6,400	6,200	6,100	7,500	7,000	6,800	7,900	7,400	7,000
105	4,800	4,900	4,900	6,100	5,900	5,800	7,100	6,700	6,500	7,600	7,100	6,800
110	4,500	4,500	4,600	5,700	5,600	5,500	6,700	6,400	6,200	7,200	6,800	6,500
115	4,200	4,200	4,200	5,400	5,300	5,200	6,400	6,100	5,900	6,900	6,500	6,200
120	3,900	3,900	3,900	5,000	5,000	4,900	6,100	5,800	5,700	6,600	6,200	6,000
125	3,600	3,600	3,700	4,700	4,700	4,700	5,800	5,600	5,400	6,300	5,900	5,700
130	3,300	3,400	3,400	4,500	4,400	4,400	5,500	5,300	5,200	6,000	5,700	5,500
135	3,100	3,100	3,200	4,200	4,200	4,200	5,200	5,000	4,900	5,700	5,400	5,300
140	2,900	2,900	2,900	3,900	3,900	3,900	4,900	4,800	4,700	5,400	5,200	5,000
145	2,600	2,700		3,700	3,700	3,700	4,700	4,500	4,500	5,100	4,900	4,800
150	2,500	2,500		3,500	3,500	3,500	4,400	4,300	4,300	4,900	4,700	4,600
155				3,300	3,300	3,300	4,200	4,100	4,100	4,700	4,500	4,400
160				3,100	3,100	3,100	4,000	3,900	3,900	4,400	4,300	4,200
165				2,900	2,900	2,900	3,800	3,700	3,700	4,200	4,100	4,100
170				2,700	2,700		3,600	3,500	3,500	4,000	3,900	3,900
175				2,600			3,400	3,400	3,400	3,800	3,700	3,700
180							3,200	3,200	3,200	3,700	3,600	3,600
185							3,100	3,100	3,100	3,500	3,400	3,400
190							2,900	2,900	2,900	3,300	3,300	3,300
195							2,800	2,800	2,800	3,200	3,100	3,100
200							2,600	2,600		3,000	3,000	3,000
205							2,500			2,900	2,900	2,900
210										2,700	2,700	2,700
215										2,600	2,600	
220										2,500		
Min Angle	0.0	0.0	0.0	13.5	24.0	29.5	15.0	23.5	27.5	16.5	24.0	26.0
Max Rad.	152.9	152.4	149.4	180.0	175.0	166.2	210.0	205.0	196.4	225.0	220.0	212.0
Capacity	2,400	2,400	2,500	0	0	0	0	0	0	0	0	0

1062150



PORTLAND OFFICE: 503.283.3111
 SEATTLE OFFICE: 206.784.1054
WWW.NESSCAMPBELL.COM

Rated Lifting Capacities in Pounds

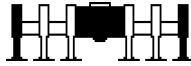

Full

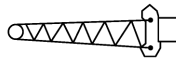

117ft Hydraulic Offset Fly



80,000 lbs



Radius (ft)	Boom Length (ft)								
	Fly Offset								
	135.4			152.0			168.5		
	2°-15°	15°-30°	30°-45°	2°-15°	15°-30°	30°-45°	2°-15°	15°-30°	30°-45°
45	12,700								
50	12,700			11,900			10,200		
55	12,700			11,900			10,200		
60	11,700	11,700		11,700	11,700		10,200		
65	11,100	11,100		11,500	11,500		10,000	10,000	
70	10,700	9,700	9,700	11,000	11,000		10,000	10,000	
75	10,200	9,300	9,300	10,500	9,500	9,500	10,000	10,000	
80	9,800	8,900	8,900	10,100	9,200	9,200	10,000	10,000	
85	9,300	8,600	8,100	9,700	8,900	8,300	10,000	9,100	9,100
90	9,000	8,300	7,800	9,300	8,500	8,000	9,700	8,800	8,800
95	8,600	8,000	7,500	9,000	8,200	7,700	9,300	8,500	7,900
100	8,300	7,700	7,300	8,600	8,000	7,500	9,000	8,200	7,700
105	7,900	7,400	7,000	8,300	7,700	7,300	8,700	7,900	7,400
110	7,600	7,100	6,700	8,000	7,400	7,000	8,300	7,700	7,200
115	7,300	6,800	6,500	7,700	7,100	6,700	8,100	7,400	7,000
120	7,000	6,500	6,200	7,400	6,900	6,500	7,800	7,200	6,700
125	6,700	6,300	6,000	7,100	6,600	6,300	7,500	6,900	6,500
130	6,400	6,000	5,800	6,800	6,400	6,100	7,200	6,700	6,300
135	6,100	5,800	5,600	6,600	6,100	5,800	7,000	6,400	6,100
140	5,900	5,600	5,400	6,300	5,900	5,600	6,700	6,200	5,900
145	5,600	5,300	5,100	6,000	5,700	5,400	6,400	6,000	5,700
150	5,400	5,100	4,900	5,800	5,400	5,200	6,200	5,800	5,500
155	5,100	4,900	4,700	5,500	5,200	5,000	6,000	5,600	5,300
160	4,900	4,700	4,600	5,300	5,000	4,900	5,700	5,400	5,100
165	4,700	4,500	4,400	5,100	4,800	4,700	5,500	5,200	5,000
170	4,400	4,300	4,200	4,900	4,600	4,500	5,300	5,000	4,800
175	4,200	4,100	4,000	4,700	4,400	4,300	5,100	4,800	4,600
180	4,100	3,900	3,900	4,500	4,300	4,200	4,900	4,600	4,500
185	3,900	3,800	3,700	4,300	4,100	4,000	4,700	4,400	4,300
190	3,700	3,600	3,600	4,100	3,900	3,900	4,500	4,300	4,200
195	3,500	3,500	3,500	3,900	3,800	3,800	4,000	4,100	4,000
200	3,400	3,300	3,300	3,800	3,700	3,600	3,500	4,000	3,900
205	3,200	3,200	3,200	3,600	3,500	3,500	3,100	3,600	3,800
210	3,100	3,100	3,100	3,500	3,400	3,400	2,600	3,200	3,600
215	3,000	2,900	2,900	3,300	3,300	3,300	2,200	2,700	3,100
220	2,800	2,800	2,800	2,900	3,100	3,100		2,300	2,700
225	2,700	2,700	2,700	2,600	2,900	3,000			2,300
230	2,600	2,600		2,200	2,500	2,700			
235	2,500				2,200	2,200			
Min Angle	18.0	25.0	24.0	33.5	33.5	33.0	45.5	46.0	46.0
Max Rad. Capacity	240.0	235.0	228.1	233.3	237.5	237.5	218.3	223.8	228.8
	0	0	0	0	0	0	0	0	0

1062150



PORTLAND OFFICE: 503.283.3111
 SEATTLE OFFICE: 206.784.1054
WWW.NESSCAMPBELL.COM

Rated Lifting Capacities in Pounds

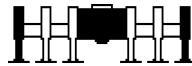

Full

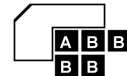

102,000 lbs



Boom Length (ft)											
Extend Mode											
Radius (ft)	44.3	58.9	59.4	59.9	73.5	74.0	75.0	75.9	88.7	89.1	89.6
	ALL	EM2, EM5	EM6	EM7	EM1, EM3, EM4	EM5	EM6	EM7	EM4	EM2	EM5
10	295,200	195,200	295,700	294,800	134,800	196,100	247,000	262,200	125,300	120,100	168,700
12	266,300	182,900	267,700	266,800	125,600	182,200	228,300	256,800	117,000	112,200	168,700
15	231,400	167,200	233,500	232,600	114,000	164,700	205,000	231,800	106,200	102,000	161,600
20	187,400	146,500	190,300	189,300	98,600	141,800	175,200	189,100	91,900	88,500	140,000
25	156,100	130,500	159,200	158,300	86,700	124,400	152,800	158,300	80,800	78,000	123,300
30	128,000	117,900	132,300	131,000	75,900	110,800	133,500	131,400	72,100	69,600	110,000
35	107,000	107,700	111,400	110,200	67,200	99,800	112,700	110,600	65,000	62,800	99,200
40		96,500	95,600	94,400	60,000	90,700	97,000	94,800	59,100	57,100	90,200
45		84,100	83,100	81,900	54,100	83,200	84,600	82,500	54,100	51,700	82,800
50		58,500	73,100	71,900	49,300	76,200	74,500	72,400	49,900	47,100	76,400
55					45,200	68,000	66,300	64,200	46,200	43,300	68,600
60					41,900	61,100	59,400	57,300	43,100	39,900	61,700
65						45,300	53,200	51,000	40,300	37,000	55,700
70									37,900	34,400	49,700
75									35,800	32,200	44,600
80									25,000	30,300	39,500
Unpinned		101,200	89,600	80,400	55,600	95,600	89,600	72,800	98,200	56,000	83,900
Min Angle	0.0	0.0	0.0	0.0	0.0	0.0	0.0	0.0	0.0	0.0	0.0
Max Rad. Capacity	35.7	50.4	50.8	51.3	65.0	65.5	66.4	67.4	80.1	80.6	81.1
Capacity	66,600	22,600	48,400	47,000	12,200	19,400	36,200	33,900	10,700	16,400	16,100

1070010



PORTLAND OFFICE: 503.283.3111
 SEATTLE OFFICE: 206.784.1054
WWW.NESSCAMPBELL.COM

Rated Lifting Capacities in Pounds

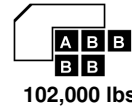
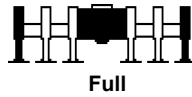

		Boom Length (ft)										
		Extend Mode										
Radius (ft)	91.0	92.5	103.8	104.2	105.7	107.6	119.4	120.3	120.3	122.2	124.1	134.9
	EM6	EM7	EM1, EM3	EM4	EM5	EM6	EM3	EM4	EM2	EM5	EM6	EM1
10	212,200	203,700										
12	212,200	203,700										
15	198,500	203,700	84,300	100,600	128,900							
20	169,700	184,600	76,600	97,200	128,900	172,300	66,300	92,800	77,300	120,900	129,700	54,700
25	148,100	157,100	67,600	86,600	124,700	153,000	66,300	91,000	69,400	120,900	112,800	54,700
30	131,200	130,100	60,300	78,100	111,500	131,600	64,000	82,700	62,100	118,300	99,400	54,700
35	112,500	109,400	54,400	71,000	100,600	111,100	58,200	75,900	56,200	107,800	88,400	52,400
40	96,800	93,800	49,500	65,000	91,600	95,500	53,300	70,000	51,200	97,100	79,400	47,800
45	84,400	81,400	45,300	60,000	83,900	83,200	48,900	64,900	46,900	84,900	71,900	43,800
50	74,400	71,400	41,700	55,700	76,300	73,200	45,100	60,500	43,200	74,900	65,400	40,400
55	66,200	63,300	38,700	51,900	68,100	65,100	41,800	56,700	40,000	66,800	59,800	37,400
60	59,300	56,400	36,000	48,600	61,200	58,100	38,900	53,300	37,200	59,900	55,000	34,800
65	53,100	50,000	33,400	45,700	55,100	51,900	36,400	50,300	34,700	53,500	50,700	32,400
70	47,200	44,000	31,000	43,000	49,200	45,900	34,100	47,600	32,500	47,700	44,900	30,400
75	42,100	39,000	28,900	40,700	44,100	40,900	32,100	45,200	30,500	42,700	39,900	28,500
80	37,800	34,800	27,100	38,700	39,800	36,600	30,300	41,200	28,700	38,400	35,700	26,800
85			25,400	36,800	36,000	33,000	28,600	37,500	27,100	34,700	32,200	25,300
90			24,000	34,900	32,900	29,800	27,100	34,300	25,600	31,600	29,000	23,900
95			21,700	25,500	30,000	27,000	25,700	31,400	24,300	28,800	26,100	22,600
100							24,500	28,900	23,100	26,200	23,600	21,400
105							23,400	26,700	21,800	24,000	21,400	20,300
110							21,600	24,700	20,800	22,000	19,400	19,300
115											17,700	18,400
120												17,600
125												16,800
Unpinned	74,300	60,200	60,700	86,100	75,900	61,400	66,300	77,900	60,700	61,800	44,600	54,700
Min Angle	0.0	0.0	0.0	0.0	0.0	0.0	0.0	0.0	0.0	0.0	0.0	0.0
Max Rad.	82.5	83.9	95.2	95.7	97.1	99.0	110.8	111.7	111.8	113.7	115.6	126.4
Capacity	26,900	23,600	9,400	9,100	12,800	19,000	7,900	7,300	11,300	9,500	13,200	6,700

1070010



PORTLAND OFFICE: 503.283.3111
 SEATTLE OFFICE: 206.784.1054
WWW.NESSCAMPBELL.COM

Rated Lifting Capacities in Pounds

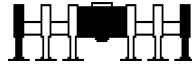

Full



102,000 lbs



Boom Length (ft)											
Extend Mode											
Radius (ft)	135.4	136.8	152.0	152.4	153.4	167.1	168.5	169.0	183.6	185.5	200.1
	EM3	EM4	EM3	EM2	EM4	EM1	EM3	EM2	EM1	EM2	EM1
20	65,600	91,400									
25	65,600	91,400	65,300	57,200	73,000	41,200					
30	65,600	85,500	65,300	57,200	73,000	41,200	55,000	53,300	38,700	41,300	
35	61,700	79,100	64,100	54,500	73,000	41,200	55,000	53,300	38,700	41,300	33,000
40	57,000	73,500	59,600	49,800	69,700	41,200	55,000	52,200	38,700	41,300	33,000
45	52,800	68,600	55,600	45,700	63,800	41,200	55,000	48,200	38,700	41,300	33,000
50	49,100	64,100	52,100	41,900	58,600	40,500	53,500	44,300	38,700	41,300	33,000
55	45,800	60,400	48,900	38,800	54,100	37,600	50,500	41,300	38,700	41,300	33,000
60	42,700	57,000	46,100	36,000	50,100	34,900	47,600	38,500	37,200	40,200	33,000
65	40,100	54,000	43,200	33,600	46,500	32,500	44,300	36,100	34,800	37,800	33,000
70	37,700	49,000	40,800	31,300	43,300	30,400	41,400	33,800	32,700	35,600	33,000
75	35,600	44,000	38,700	29,300	40,500	28,500	38,700	31,800	30,700	33,700	32,600
80	33,700	39,700	36,700	27,500	37,900	26,700	36,400	30,000	29,000	31,900	30,800
85	31,900	36,000	34,900	25,900	34,800	25,100	34,200	28,300	27,300	30,200	29,100
90	30,300	33,000	33,300	24,400	31,800	23,700	32,200	26,800	25,800	28,600	27,600
95	28,900	30,100	30,800	23,000	29,000	22,200	29,700	25,300	24,400	27,200	26,200
100	27,600	27,600	28,300	21,600	26,500	21,000	27,200	24,000	23,200	25,800	25,000
105	26,300	25,300	26,000	20,400	24,300	19,900	25,000	22,800	21,900	24,000	23,800
110	25,200	23,300	24,000	19,300	22,300	18,900	23,000	21,400	20,800	22,000	22,400
115	23,400	21,500	22,200	18,400	20,500	17,900	21,200	20,400	19,800	20,200	21,000
120	21,800	19,900	20,500	17,400	18,800	17,000	19,500	19,500	18,900	18,600	19,400
125	20,300	18,400	19,000	16,600	17,300	16,200	18,000	18,000	18,000	17,100	17,900
130			17,700	15,800	16,100	15,400	16,800	16,800	17,200	16,000	16,800
135			16,500	15,000	14,800	14,600	15,500	15,500	16,400	14,700	15,600
140			15,400	14,300	13,700	14,000	14,400	14,300	15,200	13,500	14,400
145						13,300	13,300	13,300	14,100	12,500	13,300
150						12,700	12,300	12,300	13,100	11,500	12,300
155						12,100	11,400	11,300	12,200	10,600	11,400
160								10,200	11,300	9,700	10,500
165									10,500	8,900	9,700
170									9,800	8,200	9,000
175										7,500	8,300
180											7,600
185											7,000
Unpinned	65,600	63,400	65,200	57,200	63,200	41,200	55,000	53,300	38,700	41,300	33,000
Min Angle	0.0	0.0	0.0	0.0	0.0	0.0	0.0	0.0	0.0	0.0	13.5
Max Rad.	126.9	128.3	143.4	143.9	144.8	158.5	159.9	160.4	175.1	177.0	190.0
Capacity	6,400	5,300	4,500	7,000	3,500	4,000	2,900	4,800	2,500	2,900	0

1070010



PORTLAND OFFICE: 503.283.3111
 SEATTLE OFFICE: 206.784.1054
WWW.NESSCAMPBELL.COM

Rated Lifting Capacities in Pounds

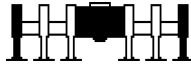

Full

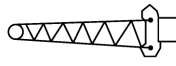

12ft Offset Fly
2° - 45°

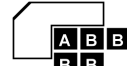

102,000 lbs



Boom Length (ft)											
Extend Mode											
Radius (ft)	44.3	58.9	59.4	59.9	73.5	74.0	75.0	75.9	88.7	89.1	89.6
	ALL	EM2, EM5	EM6	EM7	EM1, EM3, EM4	EM5	EM6	EM7	EM4	EM2	EM5
10	69,600	69,500	69,500	69,500	69,400	69,400	69,400	69,400	69,400	69,400	69,300
12	69,600	69,500	69,500	69,500	69,400	69,400	69,400	69,400	69,400	69,400	69,300
15	69,600	69,500	69,500	69,500	69,400	69,400	69,400	69,400	69,400	69,400	69,300
20	69,600	69,500	69,500	69,500	69,400	69,400	69,400	69,400	69,400	69,400	69,300
25	69,600	69,500	69,500	69,500	69,400	69,400	69,400	69,400	69,400	69,400	69,300
30	66,700	69,500	69,500	69,500	64,100	69,400	69,400	69,400	63,700	62,300	69,300
35	61,800	69,400	69,500	69,500	57,500	69,400	69,400	69,400	57,200	56,000	69,300
40	57,700	66,200	69,500	69,500	51,300	69,400	69,400	69,400	51,900	50,700	69,300
45	54,700	62,300	65,800	66,100	46,300	68,600	69,400	69,400	47,400	46,300	69,300
50		59,000	62,200	62,400	42,600	66,000	69,400	69,400	43,900	42,600	69,300
55		55,900	59,100	59,300	39,000	62,300	66,600	65,400	40,600	38,900	64,700
60		53,000	57,000	57,100	35,900	58,000	60,400	58,500	37,700	35,800	60,200
65					33,200	54,200	54,100	52,200	35,100	33,000	55,600
70					30,900	50,000	48,300	46,300	32,900	30,600	49,700
75					28,900	45,000	43,400	41,400	30,900	28,500	44,700
80									29,100	26,600	40,400
85									27,600	25,000	36,800
90									26,200	23,500	33,700
Unpinned		69,500	69,500	69,500	55,600	69,400	69,400	69,400	69,400	56,000	69,300
Min Angle	0.0	0.0	0.0	0.0	0.0	0.0	0.0	0.0	0.0	0.0	0.0
Max Rad.	46.4	61.0	61.5	61.9	75.6	76.1	77.0	78.0	90.7	91.2	91.7
Capacity	30,500	14,600	25,100	24,400	7,900	12,500	20,600	19,300	6,800	10,700	10,400

1073010



PORTLAND OFFICE: 503.283.3111
 SEATTLE OFFICE: 206.784.1054
WWW.NESSCAMPBELL.COM

Rated Lifting Capacities in Pounds

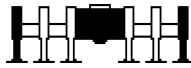

Full

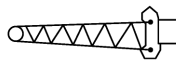

12ft Offset Fly
2° - 45°



102,000 lbs



360°

Radius (ft)	Boom Length (ft)											
	Extend Mode											
	91.0	92.5	103.8	104.2	105.7	107.6	119.4	120.3	120.3	122.2	124.1	134.9
	EM6	EM7	EM1, EM3	EM4	EM5	EM6	EM3	EM4	EM2	EM5	EM6	EM1
10	69,300	69,300										
12	69,300	69,300										
15	69,300	69,300	62,700	69,300	69,300	69,200	54,600	69,200	61,000	69,200	69,100	
20	69,300	69,300	62,700	69,300	69,300	69,200	54,600	69,200	61,000	69,200	69,100	42,600
25	69,300	69,300	61,800	69,300	69,300	69,200	54,600	69,200	61,000	69,200	69,100	42,600
30	69,300	69,300	55,000	68,300	69,300	69,200	54,600	69,200	58,300	69,200	69,100	42,600
35	69,300	69,300	49,400	62,100	69,300	69,200	52,600	66,100	52,500	69,200	69,100	42,600
40	69,300	69,300	45,000	56,700	69,300	69,200	48,000	60,800	47,700	69,200	69,100	42,600
45	69,300	69,300	41,100	52,100	69,300	69,200	44,300	56,200	43,700	69,200	69,100	41,000
50	69,300	69,300	37,700	48,200	69,300	69,200	40,900	52,200	40,100	69,200	63,500	37,700
55	66,500	63,700	34,800	45,000	67,100	64,900	37,900	48,700	37,000	66,200	58,000	34,800
60	59,600	56,900	32,200	42,000	60,900	58,000	35,300	45,700	34,300	59,300	53,200	32,200
65	53,200	50,400	30,000	39,300	54,600	51,600	33,000	43,100	31,900	52,800	49,000	29,900
70	47,400	44,500	27,900	37,000	48,700	45,700	31,000	40,600	29,700	47,000	44,400	27,900
75	42,400	39,500	25,900	34,800	43,700	40,700	29,100	38,400	27,800	42,000	39,400	26,000
80	38,200	35,300	24,200	32,900	39,400	36,500	27,400	36,400	26,000	37,800	35,200	24,400
85	34,600	31,800	22,600	31,200	35,800	33,000	25,700	34,600	24,500	34,300	31,700	22,900
90	31,500	28,700	21,500	29,700	32,700	29,800	24,200	33,000	23,100	31,100	28,600	21,700
95			20,100	28,300	29,900	27,000	22,800	30,800	21,800	28,300	25,800	20,400
100			18,900	27,100	27,400	24,600	21,800	28,300	20,600	25,800	23,400	19,300
105			17,900	26,100	25,300	22,400	20,600	26,100	19,500	23,600	21,200	18,200
110							19,500	24,100	18,500	21,700	19,300	17,300
115							18,600	22,400	17,500	19,900	17,500	16,400
120							17,700	20,800	16,700	18,300	16,000	15,500
125											14,600	14,700
130												14,000
135												13,400
Unpinned	69,300	60,200	60,700	69,300	69,300	61,400	54,600	69,200	60,700	61,800	44,600	42,600
Min Angle	0.0	0.0	0.0	0.0	0.0	0.0	0.0	0.0	0.0	0.0	0.0	0.0
Max Rad.	93.1	94.5	105.8	106.3	107.7	109.7	121.4	122.4	122.4	124.3	126.2	137.0
Capacity	16,000	14,000	5,900	5,600	8,100	11,600	4,800	4,200	7,200	5,700	8,000	3,800

1073010



PORTLAND OFFICE: 503.283.3111
SEATTLE OFFICE: 206.784.1054
WWW.NESSCAMPBELL.COM

Rated Lifting Capacities in Pounds

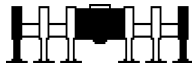

Full

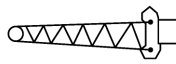

12ft Offset Fly
2° - 45°



102,000 lbs



360°

Boom Length (ft)											
Extend Mode											
Radius (ft)	135.4	136.8	152.0	152.4	153.4	167.1	168.5	169.0	183.6	185.5	200.1
	EM3	EM4	EM3	EM2	EM4	EM1	EM3	EM2	EM1	EM2	EM1
25	55,600	69,100	55,000	49,300	59,000	35,100	43,000	42,100			
30	55,600	69,100	55,000	49,100	59,000	35,100	43,000	42,100	32,900	35,400	
35	55,600	68,900	55,000	49,100	59,000	35,100	43,000	42,100	32,900	35,400	28,100
40	51,100	63,800	53,400	47,200	59,000	35,100	43,000	42,100	32,900	35,400	28,100
45	47,200	59,300	49,600	43,200	59,000	35,100	43,000	42,100	32,900	35,400	28,100
50	43,900	55,400	46,300	39,700	56,500	35,100	43,000	41,800	32,900	35,400	28,100
55	40,900	52,000	43,300	36,600	52,000	35,100	43,000	38,800	32,900	35,400	28,100
60	38,200	48,900	40,700	33,900	48,100	32,800	42,100	36,100	32,900	35,400	28,100
65	35,900	46,100	38,300	31,400	44,800	30,400	39,800	33,700	32,500	35,200	28,100
70	33,800	43,700	36,200	29,300	41,700	28,300	37,800	31,500	30,400	33,100	28,100
75	31,900	41,400	34,300	27,300	38,800	26,400	35,900	29,500	28,500	31,100	28,100
80	30,200	38,800	32,500	25,500	36,200	24,700	34,200	27,700	26,700	29,400	28,100
85	28,600	35,100	30,900	23,900	33,900	23,100	32,500	26,000	25,100	27,700	26,800
90	27,100	32,100	29,400	22,400	30,900	21,800	30,500	24,500	23,700	26,200	25,300
95	25,700	29,300	28,100	21,000	28,100	20,500	28,600	23,100	22,300	24,800	23,900
100	24,300	26,800	26,800	19,800	25,600	19,300	26,100	21,700	21,100	23,500	22,700
105	23,100	24,600	25,000	18,600	23,400	18,100	23,900	20,600	19,900	22,000	21,400
110	22,100	22,600	23,000	17,600	21,400	17,100	21,900	19,500	18,900	20,900	20,400
115	21,000	20,800	21,200	16,600	19,600	16,100	20,100	18,500	17,900	19,100	19,400
120	20,100	19,200	19,600	15,600	18,000	15,200	18,500	17,500	17,000	17,500	18,100
125	19,200	17,800	18,100	14,800	16,700	14,400	17,100	16,600	16,100	16,200	16,900
130	18,200	16,500	17,000	14,000	15,400	13,600	15,800	15,800	15,300	14,900	15,600
135	17,100	15,300	15,700	13,200	14,100	12,900	14,600	14,500	14,500	13,600	14,300
140			14,600	12,500	13,000	12,200	13,500	13,400	13,800	12,500	13,200
145			13,500	11,900	12,000	11,500	12,400	12,400	13,000	11,500	12,100
150				11,300	11,000	10,900	11,400	11,400	12,100	10,500	11,200
155						10,300	10,500	10,500	11,100	9,600	10,200
160						9,800	9,700	9,700	10,300	8,700	9,400
165							9,000	8,900	9,500	8,000	8,600
170								8,200	8,800	7,200	7,900
175									8,100	6,600	7,200
180									7,500	5,900	6,600
185											6,000
190											5,400
195											4,900
Unpinned	55,600	63,400	55,000	49,300	59,000	35,100	43,000	42,100	32,900	35,400	28,100
Min Angle	0.0	0.0	19.0	0.0	10.0	18.0	10.5	0.0	11.5	15.0	14.0
Max Rad.	137.5	138.9	150.0	154.5	155.0	165.0	170.0	171.0	185.0	185.0	200.0
Capacity	3,500	2,600	0	3,900	0	0	0	2,200	0	0	0

1073010



PORTLAND OFFICE: 503.283.3111
SEATTLE OFFICE: 206.784.1054
WWW.NESSCAMPBELL.COM

Rated Lifting Capacities in Pounds

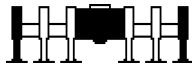

Full

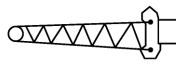

40ft Offset Fly



102,000 lbs



Radius (ft)	Boom Length (ft)											
	Fly Offset											
	44.3				73.5				103.8			
	2°	15°	30°	45°	2°	15°	30°	45°	2°	15°	30°	45°
10	34,700											
12	34,700				34,600							
15	34,700	34,700			34,600							
20	34,700	32,000			34,600	34,600			34,500			
25	33,900	28,800	24,900		34,600	32,900			34,500			
30	30,200	26,200	22,900	20,200	34,600	30,300	25,100		34,500	33,500		
35	27,200	24,000	20,700	19,000	34,500	28,100	23,600	20,300	34,500	31,400	25,200	
40	24,800	21,400	19,400	18,000	31,600	26,200	21,700	19,500	34,500	29,500	24,000	20,400
45	21,900	19,900	18,200	17,200	29,100	24,600	20,700	18,700	34,500	27,800	23,000	19,700
50	20,200	18,600	17,300	16,400	27,000	23,100	19,700	18,000	32,500	26,300	21,500	19,100
55	18,800	17,500	16,400	15,800	25,100	21,200	18,900	17,400	30,400	25,000	20,700	18,500
60	17,500	16,500	15,700	15,300	23,500	20,100	18,100	16,900	28,600	23,800	20,000	18,000
65	16,400	15,600	15,000	14,900	21,400	19,200	17,400	16,400	26,700	22,700	19,300	17,500
70	15,400	14,900	14,600		20,200	18,300	16,800	15,900	24,800	21,200	18,600	17,100
75	14,500	14,300			19,200	17,500	16,200	15,600	23,200	20,400	18,000	16,700
80					18,200	16,800	15,700	15,300	22,000	19,600	17,500	16,400
85					17,300	16,100	15,300	15,000	20,600	18,800	17,000	16,000
90					16,500	15,500	14,900		19,400	18,200	16,600	15,700
95					15,700	15,000	14,600		18,100	17,600	16,200	15,500
100					15,100	14,600			17,000	17,000	15,800	15,300
105					9,500				16,000	16,000	15,400	15,100
110									15,100	15,100	15,100	14,900
115									14,300	14,300	14,300	
120									13,500	13,500	13,500	
125									12,800	12,800	12,800	
130									12,200	12,200		
135									8,800			
Min Angle	0.0	0.0	0.0	0.0	0.0	0.0	0.0	0.0	0.0	0.0	0.0	0.0
Max Rad.	75.9	75.8	74.5	71.9	105.1	104.9	103.2	100.0	135.3	135.1	133.1	129.6
Capacity	11,200	11,400	12,100	13,600	3,700	3,700	3,900	4,200	2,600	2,600	2,700	2,900

1071040



PORTLAND OFFICE: 503.283.3111
 SEATTLE OFFICE: 206.784.1054
WWW.NESSCAMPBELL.COM

Rated Lifting Capacities in Pounds

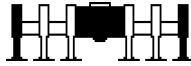

Full

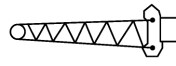

40ft Offset Fly



102,000 lbs



Radius (ft)	Boom Length (ft)											
	Fly Offset											
	134.9				167.1				183.6			
	2°	15°	30°	45°	2°	15°	30°	45°	2°	15°	30°	45°
25	29,700											
30	29,700				19,800							
35	29,700	29,500			19,800				18,600			
40	29,700	29,500			19,800	19,700			18,600			
45	29,700	29,500	24,300		19,800	19,700			18,600	18,500		
50	29,700	29,000	23,400	19,900	19,800	19,700	19,600		18,600	18,500		
55	29,700	27,700	22,100	19,300	19,800	19,700	19,600		18,600	18,500	18,300	
60	29,700	26,400	21,400	18,900	19,800	19,700	19,600	19,300	18,600	18,500	18,300	18,000
65	27,800	25,300	20,700	18,400	19,800	19,700	19,600	19,100	18,600	18,500	18,300	18,000
70	25,800	24,300	20,100	18,000	19,800	19,700	19,600	18,700	18,600	18,500	18,300	18,000
75	24,100	23,400	19,600	17,600	19,800	19,700	19,600	18,400	18,600	18,500	18,300	18,000
80	22,500	22,000	19,000	17,300	19,800	19,700	19,600	18,000	18,600	18,500	18,300	18,000
85	21,300	21,200	18,500	17,000	19,800	19,700	19,600	17,700	18,600	18,500	18,300	18,000
90	20,000	19,900	18,000	16,600	19,800	19,700	19,300	17,400	18,600	18,500	18,300	17,700
95	18,800	18,800	17,600	16,400	19,300	19,400	18,900	17,100	18,600	18,500	18,300	17,500
100	17,700	17,700	17,200	16,100	18,200	18,300	18,300	16,900	18,600	18,500	18,300	17,200
105	16,700	16,700	16,700	15,800	17,100	17,200	17,300	16,600	18,500	18,500	18,300	16,900
110	15,800	15,800	15,800	15,600	16,100	16,200	16,300	16,400	17,500	17,500	17,500	16,700
115	15,000	15,000	15,000	15,000	15,200	15,300	15,400	15,500	16,600	16,600	16,600	16,500
120	14,200	14,200	14,200	14,200	14,300	14,500	14,600	14,700	15,700	15,700	15,800	15,800
125	13,500	13,500	13,500	13,500	13,500	13,700	13,800	13,900	14,900	14,900	15,000	15,000
130	12,800	12,800	12,800	12,900	12,800	12,900	13,100	13,100	14,100	14,200	14,200	14,300
135	12,100	12,200	12,200	12,200	12,100	12,200	12,400	12,400	13,400	13,500	13,500	13,600
140	11,500	11,600	11,600		11,400	11,600	11,700	11,800	12,700	12,800	12,900	12,900
145	11,000	11,000	11,100		10,800	10,900	11,100	11,100	12,100	12,200	12,200	12,300
150	10,500	10,500	10,500		10,200	10,400	10,500	10,500	11,500	11,600	11,600	11,700
155	10,000	10,000	10,000		9,700	9,800	9,900	10,000	10,900	11,000	11,100	11,100
160	9,500	9,600			9,200	9,300	9,400	9,400	10,400	10,400	10,500	10,600
165					8,700	8,800	8,900	8,900	9,800	9,900	10,000	10,000
170					8,200	8,300	8,400		9,400	9,400	9,500	9,500
175					7,800	7,900	7,900		8,800	9,000	9,100	9,100
180					7,400	7,500	7,500		8,200	8,400	8,600	8,600
185					7,000	7,100	7,100		7,500	7,800	8,000	
190					6,600	6,700			7,000	7,200	7,300	
195									6,400	6,600	6,700	
200									5,900	6,000	6,100	
205									5,400	5,500		
210									5,000			
Min Angle	13.5	15.0	23.5	4.0	17.5	19.0	16.5	21.0	10.5	20.5	19.0	23.0
Max Rad.	165.0	165.0	160.0	158.4	195.0	195.0	195.0	190.0	213.5	210.0	210.0	205.0
Capacity	0	0	0	0	0	0	0	0	0	0	0	0

1071040



PORTLAND OFFICE: 503.283.3111
 SEATTLE OFFICE: 206.784.1054
WWW.NESSCAMPBELL.COM

Rated Lifting Capacities in Pounds

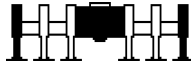

Full

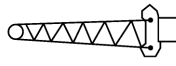

40ft Offset Fly



102,000 lbs



Radius (ft)	Boom Length (ft)			
	Fly Offset			
	200.1			
	2°	15°	30°	45°
40	16,100			
45	16,100			
50	16,100	16,100		
55	16,100	16,100		
60	16,100	16,100	15,900	
65	16,100	16,100	15,900	15,600
70	16,100	16,100	15,900	15,600
75	16,100	16,100	15,900	15,600
80	16,100	16,100	15,900	15,600
85	16,100	16,100	15,900	15,600
90	16,100	16,100	15,900	15,600
95	16,100	16,100	15,900	15,600
100	16,100	16,100	15,900	15,600
105	16,100	16,100	15,900	15,600
110	16,100	16,100	15,900	15,600
115	16,100	16,100	15,900	15,600
120	16,100	16,100	15,900	15,600
125	16,000	16,000	15,900	15,600
130	15,300	15,300	15,200	15,200
135	14,500	14,500	14,500	14,500
140	13,800	13,800	13,900	13,900
145	12,900	13,200	13,200	13,200
150	11,900	12,500	12,600	12,600
155	11,000	11,500	11,900	12,100
160	10,100	10,600	11,000	11,300
165	9,300	9,800	10,100	10,400
170	8,600	9,000	9,300	9,500
175	7,900	8,300	8,600	8,700
180	7,200	7,600	7,900	8,000
185	6,600	6,900	7,200	7,300
190	6,000	6,300	6,500	6,600
195	5,500	5,700	5,900	
200	5,000	5,200	5,400	
205	4,500	4,700	4,800	
210	4,000	4,200	4,300	
215	3,600	3,700	3,800	
220	3,200	3,300		
225	2,800	2,900		
Min Angle	13.5	14.5	21.5	24.0
Max Rad.	230.0	230.0	225.0	220.0
Capacity	0	0	0	0

1071040



PORTLAND OFFICE: 503.283.3111
 SEATTLE OFFICE: 206.784.1054
WWW.NESSCAMPBELL.COM

Rated Lifting Capacities in Pounds

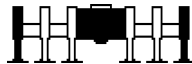

Full

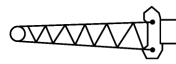

40ft Offset Fly

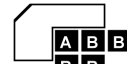

102,000 lbs



Radius (ft)	Boom Length (ft)											
	Fly Offset											
	44.3				58.9				89.1			
	2°	15°	30°	45°	2°	15°	30°	45°	2°	15°	30°	45°
10	34,700				34,700							
12	34,700				34,700							
15	34,700	34,700			34,700				34,600			
20	34,700	32,000			34,700	34,200			34,600			
25	33,900	28,800	24,900		34,700	31,100	25,900		34,600	34,600		
30	30,200	26,200	22,900	20,200	34,200	28,400	24,100		34,600	32,100	25,900	
35	27,200	24,000	20,700	19,000	31,000	26,200	21,900	19,800	34,600	29,900	24,500	
40	24,800	21,400	19,400	18,000	28,300	24,300	20,700	18,800	34,600	28,000	23,300	20,000
45	21,900	19,900	18,200	17,200	26,000	22,000	19,600	18,000	32,200	26,300	21,700	19,300
50	20,200	18,600	17,300	16,400	24,000	20,600	18,600	17,300	29,900	24,900	20,700	18,600
55	18,800	17,500	16,400	15,800	21,600	19,500	17,800	16,700	27,900	23,600	19,900	18,000
60	17,500	16,500	15,700	15,300	20,200	18,400	17,000	16,100	26,200	21,800	19,100	17,500
65	16,400	15,600	15,000	14,900	19,000	17,500	16,300	15,700	24,600	20,800	18,400	17,000
70	15,400	14,900	14,600		17,900	16,700	15,700	15,300	23,300	19,900	17,800	16,600
75	14,500	14,300			16,900	15,900	15,200	15,000	21,400	19,000	17,200	16,200
80					16,000	15,300	14,800		20,400	18,300	16,700	15,800
85					15,200	14,700	14,500		19,400	17,600	16,200	15,500
90					14,500				18,500	16,900	15,800	15,300
95									17,700	16,400	15,400	15,100
100									17,000	15,800	15,100	14,900
105									16,300	15,300	14,800	
110									15,700	14,900	14,600	
115									15,100	14,600		
120									14,500			
Min Angle	0.0	0.0	0.0	0.0	0.0	0.0	0.0	0.0	0.0	0.0	0.0	0.0
Max Rad. Capacity	75.9	75.8	74.5	71.9	90.5	90.4	88.8	85.9	120.7	120.5	118.6	115.2
	11,200	11,400	12,100	13,600	6,600	6,700	7,000	7,700	4,900	5,000	5,200	5,700

1071050



PORTLAND OFFICE: 503.283.3111
 SEATTLE OFFICE: 206.784.1054
WWW.NESSCAMPBELL.COM

Rated Lifting Capacities in Pounds

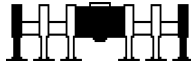

Full

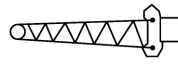

40ft Offset Fly



102,000 lbs



Radius (ft)	Boom Length (ft)											
	Fly Offset											
	120.3				152.4				169.0			
	2°	15°	30°	45°	2°	15°	30°	45°	2°	15°	30°	45°
25	34,500											
30	34,500				31,300							
35	34,500	32,800			31,300							
40	34,500	30,900			31,300				29,200			
45	34,500	29,300	23,700		31,300	31,200			29,200			
50	34,500	27,800	22,800	19,500	31,300	30,300	24,000		29,200	29,100		
55	33,100	26,500	21,500	19,000	31,300	28,900	23,200		29,200	29,100	23,800	
60	31,200	25,300	20,800	18,500	31,300	27,700	22,000	19,300	29,200	28,800	23,100	
65	29,300	24,200	20,100	18,000	29,700	26,600	21,400	18,800	29,200	27,700	22,000	19,200
70	27,300	23,200	19,500	17,600	27,600	25,600	20,800	18,400	29,200	26,700	21,400	18,800
75	25,500	21,700	18,900	17,200	25,700	24,600	20,200	18,100	27,500	25,700	20,800	18,400
80	23,800	20,900	18,300	16,900	24,000	23,700	19,700	17,700	25,800	24,800	20,300	18,100
85	22,500	20,200	17,900	16,500	22,500	22,500	19,200	17,400	24,200	24,000	19,800	17,800
90	21,100	19,500	17,400	16,200	21,100	21,200	18,800	17,100	22,800	22,600	19,400	17,400
95	19,900	18,800	17,000	16,000	19,800	19,900	18,300	16,800	21,400	21,300	18,900	17,200
100	18,800	18,200	16,600	15,700	18,700	18,700	17,900	16,500	20,200	20,100	18,500	16,900
105	17,800	17,700	16,200	15,500	17,600	17,700	17,500	16,300	19,100	19,000	18,100	16,600
110	16,800	16,800	15,800	15,300	16,600	16,700	16,800	16,000	18,000	18,000	17,800	16,400
115	15,900	15,900	15,600	15,100	15,600	15,700	15,800	15,800	17,100	17,100	17,100	16,200
120	15,100	15,100	15,100	15,000	14,800	14,900	15,000	15,100	16,200	16,200	16,200	16,000
125	14,400	14,400	14,400	14,400	13,900	14,100	14,200	14,200	15,400	15,400	15,400	15,500
130	13,700	13,700	13,700		13,200	13,300	13,400	13,500	14,600	14,600	14,700	14,700
135	13,000	13,000	13,000		12,500	12,600	12,700	12,800	13,900	13,900	14,000	14,000
140	12,400	12,400	12,400		11,800	11,900	12,000	12,100	13,200	13,200	13,300	13,300
145	11,800	11,800			11,200	11,300	11,400	11,400	12,500	12,600	12,600	12,700
150	11,300	11,300			10,600	10,700	10,800	10,800	11,900	12,000	12,000	12,100
155					10,000	10,100	10,200		11,300	11,400	11,500	11,500
160					9,500	9,600	9,700		10,600	10,900	10,900	10,900
165					9,000	9,100	9,200		9,800	10,200	10,400	10,400
170					8,600	8,600	8,700		9,100	9,400	9,600	
175					8,100	8,200			8,400	8,700	8,800	
180									7,700	8,000	8,100	
185									7,100	7,300	7,400	
190									6,600	6,700		
195									6,000	6,100		
Min Angle	0.0	0.0	0.0	0.0	17.5	19.5	17.5	22.5	9.5	7.0	20.0	24.0
Max Rad.	151.9	151.6	149.6	145.9	180.0	180.0	180.0	175.0	200.0	199.9	195.0	190.0
Capacity	3,200	3,200	3,400	3,700	0	0	0	0	0	0	0	0

1071050



PORTLAND OFFICE: 503.283.3111
 SEATTLE OFFICE: 206.784.1054
WWW.NESSCAMPBELL.COM

Rated Lifting Capacities in Pounds

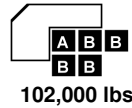
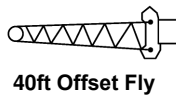
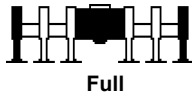

Radius (ft)	Boom Length (ft)			
	Fly Offset			
	185.5			
	2°	15°	30°	45°
40	20,200			
45	20,200			
50	20,200	20,100		
55	20,200	20,100		
60	20,200	20,100	19,900	
65	20,200	20,100	19,900	
70	20,200	20,100	19,900	19,100
75	20,200	20,100	19,900	18,700
80	20,200	20,100	19,900	18,400
85	20,200	20,100	19,900	18,100
90	20,200	20,100	19,900	17,800
95	20,200	20,100	19,500	17,500
100	20,200	20,100	19,100	17,200
105	20,200	20,100	18,700	17,000
110	19,200	19,100	18,300	16,700
115	18,300	18,200	18,000	16,500
120	17,400	17,300	17,200	16,300
125	16,500	16,500	16,400	16,100
130	15,800	15,700	15,700	15,700
135	14,700	15,000	15,000	15,000
140	13,500	14,100	14,300	14,300
145	12,500	13,000	13,500	13,700
150	11,500	12,000	12,400	12,700
155	10,600	11,000	11,400	11,700
160	9,700	10,100	10,500	10,700
165	8,900	9,300	9,600	9,800
170	8,200	8,500	8,800	9,000
175	7,500	7,800	8,100	8,200
180	6,800	7,100	7,300	7,400
185	6,200	6,500	6,700	
190	5,600	5,900	6,000	
195	5,100	5,300	5,400	
200	4,500	4,700	4,800	
205	4,100	4,200		
210	3,600	3,700		
Min Angle	14.0	15.0	21.5	10.5
Max Rad. Capacity	215.0	215.0	210.0	209.0
	0	0	0	0

1071050



PORTLAND OFFICE: 503.283.3111
 SEATTLE OFFICE: 206.784.1054
WWW.NESSCAMPBELL.COM

Rated Lifting Capacities in Pounds

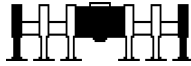

Full

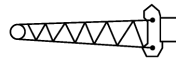

40ft Offset Fly



102,000 lbs



Radius (ft)	Boom Length (ft)											
	Fly Offset											
	44.3				73.5				103.8			
	2°	15°	30°	45°	2°	15°	30°	45°	2°	15°	30°	45°
10	34,700											
12	34,700				34,600							
15	34,700	34,700			34,600							
20	34,700	32,000			34,600	34,600			34,500			
25	33,900	28,800	24,900		34,600	32,900			34,500			
30	30,200	26,200	22,900	20,200	34,600	30,300	25,100		34,500	33,500		
35	27,200	24,000	20,700	19,000	34,500	28,100	23,600	20,300	34,500	31,400	25,200	
40	24,800	21,400	19,400	18,000	31,600	26,200	21,700	19,500	34,500	29,500	24,000	20,400
45	21,900	19,900	18,200	17,200	29,100	24,600	20,700	18,700	34,500	27,800	23,000	19,700
50	20,200	18,600	17,300	16,400	27,000	23,100	19,700	18,000	32,500	26,300	21,500	19,100
55	18,800	17,500	16,400	15,800	25,100	21,200	18,900	17,400	30,400	25,000	20,700	18,500
60	17,500	16,500	15,700	15,300	23,500	20,100	18,100	16,900	28,600	23,800	20,000	18,000
65	16,400	15,600	15,000	14,900	21,400	19,200	17,400	16,400	26,700	22,700	19,300	17,500
70	15,400	14,900	14,600		20,200	18,300	16,800	15,900	24,800	21,200	18,600	17,100
75	14,500	14,300			19,200	17,500	16,200	15,600	23,200	20,400	18,000	16,700
80					18,200	16,800	15,700	15,300	22,000	19,600	17,500	16,400
85					17,300	16,100	15,300	15,000	20,600	18,800	17,000	16,000
90					16,500	15,500	14,900		19,400	18,200	16,600	15,700
95					15,700	15,000	14,600		18,100	17,600	16,200	15,500
100					15,100	14,600			17,000	17,000	15,800	15,300
105					9,500				16,000	16,000	15,400	15,100
110									15,100	15,100	15,100	14,900
115									14,300	14,300	14,300	
120									13,500	13,500	13,500	
125									12,800	12,800	12,800	
130									12,200	12,200		
135									8,800			
Min Angle	0.0	0.0	0.0	0.0	0.0	0.0	0.0	0.0	0.0	0.0	0.0	0.0
Max Rad.	75.9	75.8	74.5	71.9	105.1	104.9	103.2	100.0	135.3	135.1	133.1	129.6
Capacity	11,200	11,400	12,100	13,600	3,700	3,700	3,900	4,200	2,600	2,600	2,700	2,900

1071060



PORTLAND OFFICE: 503.283.3111
 SEATTLE OFFICE: 206.784.1054
WWW.NESSCAMPBELL.COM

Rated Lifting Capacities in Pounds

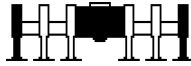

Full

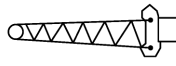

40ft Offset Fly



102,000 lbs



Radius (ft)	Boom Length (ft)											
	Fly Offset											
	119.4				135.4				152.0			
	2°	15°	30°	45°	2°	15°	30°	45°	2°	15°	30°	45°
25	33,900				34,400							
30	33,900				34,400				33,800			
35	33,900	32,700			34,400	33,900			33,800			
40	33,900	30,900	24,700		34,400	32,100			33,800	33,300		
45	33,900	29,200	23,700	20,100	34,400	30,500	24,300		33,800	31,700	24,900	
50	33,900	27,700	22,800	19,500	34,400	29,000	23,400	19,900	33,800	30,200	24,000	20,200
55	33,000	26,400	21,500	19,000	34,400	27,700	22,100	19,400	33,800	28,900	23,200	19,700
60	31,000	25,200	20,700	18,500	33,400	26,500	21,400	18,900	33,800	27,700	22,000	19,200
65	28,900	24,100	20,000	18,000	31,200	25,400	20,700	18,400	33,100	26,600	21,400	18,800
70	27,000	23,100	19,400	17,600	29,200	24,300	20,100	18,000	31,100	25,500	20,800	18,400
75	25,300	21,600	18,800	17,200	27,400	23,400	19,600	17,600	29,300	24,600	20,200	18,000
80	23,800	20,800	18,300	16,900	25,800	22,000	19,000	17,300	27,700	23,700	19,700	17,700
85	22,500	20,100	17,800	16,500	24,400	21,300	18,500	17,000	26,200	22,900	19,200	17,400
90	21,300	19,400	17,300	16,200	23,100	20,600	18,100	16,700	24,800	21,700	18,700	17,100
95	20,100	18,800	16,900	15,900	21,900	19,900	17,600	16,400	23,600	21,000	18,300	16,800
100	19,100	18,200	16,500	15,700	20,800	19,300	17,200	16,100	22,400	20,400	17,900	16,500
105	18,000	17,600	16,100	15,500	19,800	18,700	16,800	15,900	21,400	19,800	17,500	16,300
110	17,000	16,800	15,800	15,300	18,900	18,200	16,500	15,600	20,400	19,200	17,100	16,000
115	16,100	16,000	15,500	15,100	17,900	17,600	16,200	15,500	19,500	18,700	16,800	15,800
120	15,300	15,200	15,100	15,000	17,100	16,800	15,800	15,300	18,700	18,200	16,500	15,600
125	14,500	14,400	14,400	14,400	16,200	16,000	15,600	15,100	17,900	17,500	16,200	15,500
130	13,800	13,800	13,700		15,500	15,300	15,200	15,000	17,100	16,700	15,900	15,300
135	13,200	13,100	13,100		14,800	14,600	14,500	14,500	16,300	16,000	15,600	15,200
140	12,600	12,500	12,500		14,100	14,000	13,900		15,600	15,400	15,200	15,000
145	12,000	12,000			13,500	13,400	13,400		14,600	14,800	14,600	14,500
150					13,000	12,900	12,800		13,600	13,900	14,100	14,000
155					12,400	12,400	12,400		12,700	13,000	13,200	
160					12,000	11,900			11,800	12,100	12,300	
165									11,000	11,300	11,400	
170									10,300	10,500	10,600	
175									9,600	9,700		
Min Angle	11.5	13.0	0.0	0.0	14.5	16.0	24.0	3.5	16.5	18.0	16.0	21.0
Max Rad.	150.0	150.0	148.6	144.9	165.0	165.0	160.0	158.9	180.0	180.0	180.0	175.0
Capacity	0	0	2,000	2,200	0	0	0	0	0	0	0	0

1071060



PORTLAND OFFICE: 503.283.3111
 SEATTLE OFFICE: 206.784.1054
WWW.NESSCAMPBELL.COM

Rated Lifting Capacities in Pounds

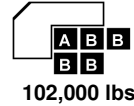
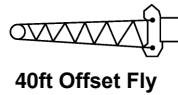
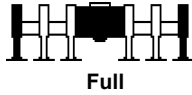

Radius (ft)	Boom Length (ft)			
	Fly Offset			
	168.5			
	2°	15°	30°	45°
35	29,200			
40	29,200			
45	29,200	29,000		
50	29,200	29,000		
55	29,200	29,000	23,800	
60	29,200	28,800	23,100	19,600
65	29,200	27,700	22,000	19,200
70	29,200	26,600	21,400	18,800
75	29,200	25,700	20,800	18,400
80	29,100	24,800	20,300	18,100
85	27,600	24,000	19,800	17,700
90	26,200	23,200	19,300	17,400
95	25,000	22,000	18,900	17,100
100	23,800	21,400	18,500	16,900
105	22,700	20,800	18,100	16,600
110	21,600	20,200	17,700	16,400
115	20,700	19,700	17,400	16,200
120	19,600	19,200	17,100	16,000
125	18,100	18,500	16,800	15,800
130	17,000	17,300	16,500	15,600
135	15,700	16,300	16,200	15,400
140	14,500	15,100	15,500	15,300
145	13,500	13,900	14,400	14,600
150	12,500	12,900	13,300	13,500
155	11,600	12,000	12,300	12,400
160	10,700	11,100	11,400	11,500
165	9,900	10,200	10,500	10,500
170	9,200	9,400	9,700	
175	8,500	8,700	8,900	
180	7,800	8,000	8,200	
185	7,200	7,400	7,500	
190	6,600	6,800		
195	6,100			
Min Angle	9.0	20.0	19.0	23.0
Max Rad.	198.5	195.0	195.0	190.0
Capacity	0	0	0	0

1071060



PORTLAND OFFICE: 503.283.3111
 SEATTLE OFFICE: 206.784.1054
WWW.NESSCAMPBELL.COM

Rated Lifting Capacities in Pounds

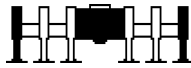

Full

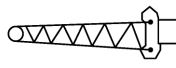

40ft Hydraulic Offset Fly



102,000 lbs



Radius (ft)	Boom Length (ft)											
	Fly Offset											
	44.3			73.5			103.8			134.9		
	2°-15°	15°-30°	30°-45°	2°-15°	15°-30°	30°-45°	2°-15°	15°-30°	30°-45°	2°-15°	15°-30°	30°-45°
10	34,700											
12	34,700	34,700		34,600								
15	34,700	34,700		34,600								
20	32,000	27,100	27,100	34,600	34,600		34,500					
25	28,800	24,900	24,900	32,900	32,900		34,500	34,500		29,700		
30	26,200	22,900	20,200	30,300	25,100	25,100	33,500	33,500		29,700		
35	24,000	20,700	19,000	28,100	23,600	20,300	31,400	25,200	25,200	29,500	29,500	
40	21,400	19,400	18,000	26,200	21,700	19,500	29,500	24,000	20,400	29,500	25,300	25,300
45	19,900	18,200	17,200	24,600	20,700	18,700	27,800	23,000	19,700	29,500	24,300	20,400
50	18,600	17,300	16,400	23,100	19,700	18,000	26,300	21,500	19,100	29,000	23,400	19,900
55	17,500	16,400	15,800	21,200	18,900	17,400	25,000	20,700	18,500	27,700	22,100	19,300
60	16,500	15,700	15,300	20,100	18,100	16,900	23,800	20,000	18,000	26,400	21,400	18,900
65	15,600	15,000	14,900	19,200	17,400	16,400	22,700	19,300	17,500	25,300	20,700	18,400
70	14,900	14,600	14,600	18,300	16,800	15,900	21,200	18,600	17,100	24,300	20,100	18,000
75	14,300	14,300		17,500	16,200	15,600	20,400	18,000	16,700	23,400	19,600	17,600
80				16,800	15,700	15,300	19,600	17,500	16,400	22,000	19,000	17,300
85				16,100	15,300	15,000	18,800	17,000	16,000	21,200	18,500	17,000
90				15,500	14,900	14,900	18,200	16,600	15,700	19,900	18,000	16,600
95				15,000	14,600	14,600	17,600	16,200	15,500	18,800	17,600	16,400
100				14,600	14,500		17,000	15,800	15,300	17,700	17,200	16,100
105				9,500			16,000	15,400	15,100	16,700	16,700	15,800
110							15,100	15,100	14,900	15,800	15,800	15,600
115							14,300	14,300	14,300	15,000	15,000	15,000
120							13,500	13,500	13,500	14,200	14,200	14,200
125							12,800	12,800	12,800	13,500	13,500	13,500
130							12,200	12,200		12,800	12,800	12,800
135							8,800			12,100	12,200	12,200
140										11,500	11,600	11,600
145										11,000	11,000	11,100
150										10,500	10,500	10,500
155										10,000	10,000	10,000
160										9,500		
Min Angle	0.0	0.0	0.0	0.0	0.0	0.0	0.0	0.0	0.0	13.5	23.5	4.0
Max Rad.	75.9	75.8	74.5	105.1	104.9	103.2	135.3	135.1	133.1	165.0	160.0	158.4
Capacity	11,200	11,400	12,100	3,700	3,700	3,900	2,600	2,600	2,700	0	0	0

1072040



PORTLAND OFFICE: 503.283.3111
 SEATTLE OFFICE: 206.784.1054
WWW.NESSCAMPBELL.COM

Rated Lifting Capacities in Pounds

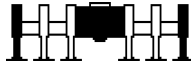

Full

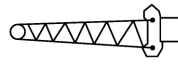

40ft Hydraulic Offset Fly



102,000 lbs



Radius (ft)	Boom Length (ft)								
	Fly Offset								
	167.1			183.6			200.1		
	2°-15°	15°-30°	30°-45°	2°-15°	15°-30°	30°-45°	2°-15°	15°-30°	30°-45°
30	19,800								
35	19,800			18,600					
40	19,700	19,700		18,400	18,400		16,100		
45	19,700	19,500	19,500	18,400	18,400		16,000	16,000	
50	19,700	19,500	19,500	18,400	18,400		16,000	16,000	
55	19,700	19,500	19,200	18,400	18,300	18,300	16,000	15,800	15,800
60	19,700	19,500	19,200	18,400	18,300	18,000	16,000	15,800	15,600
65	19,700	19,500	19,100	18,400	18,300	18,000	16,000	15,800	15,600
70	19,700	19,500	18,700	18,400	18,300	18,000	16,000	15,800	15,600
75	19,700	19,500	18,400	18,400	18,300	18,000	16,000	15,800	15,600
80	19,700	19,500	18,000	18,400	18,300	18,000	16,000	15,800	15,600
85	19,700	19,500	17,700	18,400	18,300	18,000	16,000	15,800	15,600
90	19,700	19,300	17,400	18,400	18,300	17,700	16,000	15,800	15,600
95	19,300	18,900	17,100	18,400	18,300	17,500	16,000	15,800	15,600
100	18,200	18,300	16,900	18,400	18,300	17,200	16,000	15,800	15,600
105	17,100	17,200	16,600	18,400	18,300	16,900	16,000	15,800	15,600
110	16,100	16,200	16,300	17,500	17,500	16,700	16,000	15,800	15,600
115	15,200	15,300	15,400	16,600	16,600	16,500	16,000	15,800	15,600
120	14,300	14,500	14,600	15,700	15,700	15,800	16,000	15,800	15,600
125	13,500	13,700	13,800	14,900	14,900	15,000	16,000	15,800	15,600
130	12,800	12,900	13,100	14,100	14,200	14,200	15,300	15,200	15,200
135	12,100	12,200	12,400	13,400	13,500	13,500	14,500	14,500	14,500
140	11,400	11,600	11,700	12,700	12,800	12,900	13,800	13,800	13,900
145	10,800	10,900	11,100	12,100	12,200	12,200	12,900	13,200	13,200
150	10,200	10,400	10,500	11,500	11,600	11,600	11,900	12,500	12,600
155	9,700	9,800	9,900	10,900	11,000	11,100	11,000	11,500	11,900
160	9,200	9,300	9,400	10,400	10,400	10,500	10,100	10,600	11,000
165	8,700	8,800	8,900	9,800	9,900	10,000	9,300	9,800	10,100
170	8,200	8,300	8,400	9,400	9,400	9,500	8,600	9,000	9,300
175	7,800	7,900	7,900	8,800	9,000	9,100	7,900	8,300	8,600
180	7,400	7,500	7,500	8,200	8,400	8,600	7,200	7,600	7,900
185	7,000	7,100	7,000	7,500	7,800	8,000	6,600	6,900	7,200
190	6,600	6,700		7,000	7,200	7,300	6,000	6,300	6,500
195				6,400	6,600	6,600	5,500	5,700	5,900
200				5,900	6,000	6,000	5,000	5,200	5,400
205				5,400	5,500		4,500	4,700	4,800
210							4,000	4,200	4,200
215							3,600	3,700	3,700
220							3,200	3,300	
225							2,800		
Min Angle	17.5	16.5	21.0	20.5	19.0	23.0	13.5	21.5	24.0
Max Rad.	195.0	195.0	190.0	210.0	210.0	205.0	230.0	225.0	220.0
Capacity	0	0	0	0	0	0	0	0	0

1072040



PORTLAND OFFICE: 503.283.3111
 SEATTLE OFFICE: 206.784.1054
WWW.NESSCAMPBELL.COM

Rated Lifting Capacities in Pounds

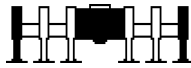

Full

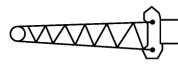

40ft Hydraulic Offset Fly



102,000 lbs



Radius (ft)	Boom Length (ft)											
	Fly Offset											
	44.3			58.9			89.1			120.3		
	2°-15°	15°-30°	30°-45°	2°-15°	15°-30°	30°-45°	2°-15°	15°-30°	30°-45°	2°-15°	15°-30°	30°-45°
10	34,700			34,700								
12	34,700	34,700		34,700								
15	34,700	34,700		34,700	34,700		34,600					
20	32,000	27,100	27,100	34,200	34,200		34,600	34,600				
25	28,800	24,900	24,900	31,100	25,900	25,900	34,600	34,600		34,500		
30	26,200	22,900	20,200	28,400	24,100	20,800	32,100	25,900	25,900	34,500	34,500	
35	24,000	20,700	19,000	26,200	21,900	19,800	29,900	24,500	20,800	32,800	25,800	25,800
40	21,400	19,400	18,000	24,300	20,700	18,800	28,000	23,300	20,000	30,900	24,700	24,700
45	19,900	18,200	17,200	22,000	19,600	18,000	26,300	21,700	19,300	29,300	23,700	20,100
50	18,600	17,300	16,400	20,600	18,600	17,300	24,900	20,700	18,600	27,800	22,800	19,500
55	17,500	16,400	15,800	19,500	17,800	16,700	23,600	19,900	18,000	26,500	21,500	19,000
60	16,500	15,700	15,300	18,400	17,000	16,100	21,800	19,100	17,500	25,300	20,800	18,500
65	15,600	15,000	14,900	17,500	16,300	15,700	20,800	18,400	17,000	24,200	20,100	18,000
70	14,900	14,600	14,600	16,700	15,700	15,300	19,900	17,800	16,600	23,200	19,500	17,600
75	14,300	14,300		15,900	15,200	15,000	19,000	17,200	16,200	21,700	18,900	17,200
80				15,300	14,800	14,800	18,300	16,700	15,800	20,900	18,300	16,900
85				14,700	14,500	14,500	17,600	16,200	15,500	20,200	17,900	16,500
90				14,300			16,900	15,800	15,300	19,500	17,400	16,200
95							16,400	15,400	15,100	18,800	17,000	16,000
100							15,800	15,100	14,900	18,200	16,600	15,700
105							15,300	14,800	14,800	17,700	16,200	15,500
110							14,900	14,600	14,600	16,800	15,800	15,300
115							14,600	14,500		15,900	15,600	15,100
120							14,400			15,100	15,100	15,000
125										14,400	14,400	14,400
130										13,700	13,700	13,700
135										13,000	13,000	13,000
140										12,400	12,400	12,400
145										11,800	11,800	
150										11,300	11,300	
Min Angle	0.0	0.0	0.0	0.0	0.0	0.0	0.0	0.0	0.0	0.0	0.0	0.0
Max Rad.	75.9	75.8	74.5	90.5	90.4	88.8	120.7	120.5	118.6	151.9	151.6	149.6
Capacity	11,200	11,400	12,100	6,600	6,700	7,000	4,900	5,000	5,200	3,200	3,200	3,400

1072050



PORTLAND OFFICE: 503.283.3111
 SEATTLE OFFICE: 206.784.1054
WWW.NESSCAMPBELL.COM

Rated Lifting Capacities in Pounds

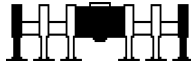

Full

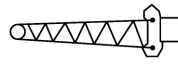

40ft Hydraulic Offset Fly



102,000 lbs



Radius (ft)	Boom Length (ft)								
	Fly Offset								
	152.4			169.0			185.5		
	2°-15°	15°-30°	30°-45°	2°-15°	15°-30°	30°-45°	2°-15°	15°-30°	30°-45°
30	31,300								
35	31,000	31,000							
40	31,000	31,000		29,200			20,200		
45	31,000	24,900	24,900	29,000	29,000		20,100	20,100	
50	30,300	24,000	20,200	29,000	24,500	24,500	20,100	20,100	
55	28,900	23,200	19,700	29,000	23,800	23,800	20,100	19,800	19,800
60	27,700	22,000	19,300	28,800	23,100	19,600	20,100	19,800	19,800
65	26,600	21,400	18,800	27,700	22,000	19,200	20,100	19,800	19,500
70	25,600	20,800	18,400	26,700	21,400	18,800	20,100	19,800	19,100
75	24,600	20,200	18,100	25,700	20,800	18,400	20,100	19,800	18,700
80	23,700	19,700	17,700	24,800	20,300	18,100	20,100	19,800	18,400
85	22,500	19,200	17,400	24,000	19,800	17,800	20,100	19,800	18,100
90	21,100	18,800	17,100	22,600	19,400	17,400	20,100	19,800	17,800
95	19,800	18,300	16,800	21,300	18,900	17,200	20,100	19,500	17,500
100	18,700	17,900	16,500	20,100	18,500	16,900	20,100	19,100	17,200
105	17,600	17,500	16,300	19,000	18,100	16,600	20,100	18,700	17,000
110	16,600	16,700	16,000	18,000	17,800	16,400	19,100	18,300	16,700
115	15,600	15,700	15,800	17,100	17,100	16,200	18,200	18,000	16,500
120	14,800	14,900	15,000	16,200	16,200	16,000	17,300	17,200	16,300
125	13,900	14,100	14,200	15,400	15,400	15,400	16,500	16,400	16,100
130	13,200	13,300	13,400	14,600	14,600	14,700	15,700	15,700	15,700
135	12,500	12,600	12,700	13,900	13,900	14,000	14,700	15,000	15,000
140	11,800	11,900	12,000	13,200	13,200	13,300	13,500	14,100	14,300
145	11,200	11,300	11,400	12,500	12,600	12,600	12,500	13,000	13,500
150	10,600	10,700	10,800	11,900	12,000	12,000	11,500	12,000	12,400
155	10,000	10,100	10,200	11,300	11,400	11,500	10,600	11,000	11,400
160	9,500	9,600	9,700	10,600	10,900	10,900	9,700	10,100	10,500
165	9,000	9,100	9,100	9,800	10,200	10,400	8,900	9,300	9,600
170	8,600	8,600	8,600	9,100	9,400	9,600	8,200	8,500	8,800
175	8,100	8,200		8,400	8,700	8,800	7,500	7,800	8,100
180				7,700	8,000	8,100	6,800	7,100	7,300
185				7,100	7,300	7,300	6,200	6,500	6,700
190				6,600	6,700		5,600	5,900	6,000
195				6,000			5,100	5,300	5,300
200							4,500	4,700	4,700
205							4,100	4,200	
210							3,600		
Min Angle	17.5	17.5	22.5	7.0	20.0	24.0	14.0	21.5	10.5
Max Rad. Capacity	180.0	180.0	175.0	199.9	195.0	190.0	215.0	210.0	209.0
	0	0	0	0	0	0	0	0	0

1072050



PORTLAND OFFICE: 503.283.3111
 SEATTLE OFFICE: 206.784.1054
WWW.NESSCAMPBELL.COM

Rated Lifting Capacities in Pounds

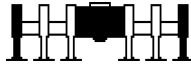

Full

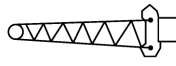

40ft Hydraulic Offset Fly



102,000 lbs



Radius (ft)	Boom Length (ft)											
	Fly Offset											
	44.3			73.5			103.8			119.4		
	2°-15°	15°-30°	30°-45°	2°-15°	15°-30°	30°-45°	2°-15°	15°-30°	30°-45°	2°-15°	15°-30°	30°-45°
10	34,700											
12	34,700	34,700		34,600								
15	34,700	34,700		34,600								
20	32,000	27,100	27,100	34,600	34,600		34,500					
25	28,800	24,900	24,900	32,900	32,900		34,500	34,500		33,900		
30	26,200	22,900	20,200	30,300	25,100	25,100	33,500	33,500		33,600	33,600	
35	24,000	20,700	19,000	28,100	23,600	20,300	31,400	25,200	25,200	32,700	25,800	25,800
40	21,400	19,400	18,000	26,200	21,700	19,500	29,500	24,000	20,400	30,900	24,700	20,700
45	19,900	18,200	17,200	24,600	20,700	18,700	27,800	23,000	19,700	29,200	23,700	20,100
50	18,600	17,300	16,400	23,100	19,700	18,000	26,300	21,500	19,100	27,700	22,800	19,500
55	17,500	16,400	15,800	21,200	18,900	17,400	25,000	20,700	18,500	26,400	21,500	19,000
60	16,500	15,700	15,300	20,100	18,100	16,900	23,800	20,000	18,000	25,200	20,700	18,500
65	15,600	15,000	14,900	19,200	17,400	16,400	22,700	19,300	17,500	24,100	20,000	18,000
70	14,900	14,600	14,600	18,300	16,800	15,900	21,200	18,600	17,100	23,100	19,400	17,600
75	14,300	14,300		17,500	16,200	15,600	20,400	18,000	16,700	21,600	18,800	17,200
80				16,800	15,700	15,300	19,600	17,500	16,400	20,800	18,300	16,900
85				16,100	15,300	15,000	18,800	17,000	16,000	20,100	17,800	16,500
90				15,500	14,900	14,900	18,200	16,600	15,700	19,400	17,300	16,200
95				15,000	14,600	14,600	17,600	16,200	15,500	18,800	16,900	15,900
100				14,600	14,500		17,000	15,800	15,300	18,200	16,500	15,700
105				9,500			16,000	15,400	15,100	17,600	16,100	15,500
110							15,100	15,100	14,900	16,800	15,800	15,300
115							14,300	14,300	14,300	16,000	15,500	15,100
120							13,500	13,500	13,500	15,200	15,100	15,000
125							12,800	12,800	12,800	14,400	14,400	14,400
130							12,200	12,200		13,800	13,700	13,700
135							8,800			13,100	13,100	13,100
140										12,500	12,500	12,500
145										12,000	12,000	
Min Angle	0.0	0.0	0.0	0.0	0.0	0.0	0.0	0.0	0.0	11.5	13.0	0.0
Max Rad.	75.9	75.8	74.5	105.1	104.9	103.2	135.3	135.1	133.1	150.0	150.0	148.6
Capacity	11,200	11,400	12,100	3,700	3,700	3,900	2,600	2,600	2,700	0	0	2,000

1072060



PORTLAND OFFICE: 503.283.3111
 SEATTLE OFFICE: 206.784.1054
WWW.NESSCAMPBELL.COM

Rated Lifting Capacities in Pounds

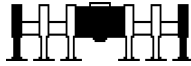

Full

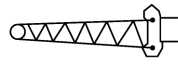

40ft Hydraulic Offset Fly



102,000 lbs



Radius (ft)	Boom Length (ft)								
	Fly Offset								
	135.4			152.0			168.5		
	2°-15°	15°-30°	30°-45°	2°-15°	15°-30°	30°-45°	2°-15°	15°-30°	30°-45°
25	34,400								
30	34,400			33,800					
35	33,900	33,900		33,500	33,500		29,200		
40	32,100	25,300	25,300	33,300	33,300		28,900	28,900	
45	30,500	24,300	20,400	31,700	24,900	24,900	28,900	28,900	
50	29,000	23,400	19,900	30,200	24,000	20,200	28,900	24,500	24,500
55	27,700	22,100	19,400	28,900	23,200	19,700	28,900	23,800	20,000
60	26,500	21,400	18,900	27,700	22,000	19,200	28,800	23,100	19,600
65	25,400	20,700	18,400	26,600	21,400	18,800	27,700	22,000	19,200
70	24,300	20,100	18,000	25,500	20,800	18,400	26,600	21,400	18,800
75	23,400	19,600	17,600	24,600	20,200	18,000	25,700	20,800	18,400
80	22,000	19,000	17,300	23,700	19,700	17,700	24,800	20,300	18,100
85	21,300	18,500	17,000	22,900	19,200	17,400	24,000	19,800	17,700
90	20,600	18,100	16,700	21,700	18,700	17,100	23,200	19,300	17,400
95	19,900	17,600	16,400	21,000	18,300	16,800	22,000	18,900	17,100
100	19,300	17,200	16,100	20,400	17,900	16,500	21,400	18,500	16,900
105	18,700	16,800	15,900	19,800	17,500	16,300	20,800	18,100	16,600
110	18,200	16,500	15,600	19,200	17,100	16,000	20,200	17,700	16,400
115	17,600	16,200	15,500	18,700	16,800	15,800	19,700	17,400	16,200
120	16,800	15,800	15,300	18,200	16,500	15,600	19,200	17,100	16,000
125	16,000	15,600	15,100	17,500	16,200	15,500	18,100	16,800	15,800
130	15,300	15,200	15,000	16,700	15,900	15,300	17,000	16,500	15,600
135	14,600	14,500	14,500	16,000	15,600	15,200	15,700	16,200	15,400
140	14,000	13,900	13,900	15,400	15,200	15,000	14,500	15,100	15,300
145	13,400	13,400	13,400	14,600	14,600	14,500	13,500	13,900	14,400
150	12,900	12,800	12,800	13,600	13,900	14,000	12,500	12,900	13,300
155	12,400	12,400	12,400	12,700	13,000	13,200	11,600	12,000	12,300
160	11,900			11,800	12,100	12,300	10,700	11,100	11,400
165				11,000	11,300	11,300	9,900	10,200	10,500
170				10,300	10,500	10,400	9,200	9,400	9,700
175				9,600	9,700		8,500	8,700	8,900
180							7,800	8,000	8,100
185							7,200	7,400	7,300
190							6,600	6,800	
Min Angle	14.5	24.0	3.5	16.5	16.0	21.0	20.0	19.0	23.0
Max Rad. Capacity	165.0	160.0	158.9	180.0	180.0	175.0	195.0	195.0	190.0
	0	0	0	0	0	0	0	0	0

1072060



PORTLAND OFFICE: 503.283.3111
 SEATTLE OFFICE: 206.784.1054
WWW.NESSCAMPBELL.COM

Rated Lifting Capacities in Pounds

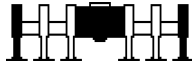

Full

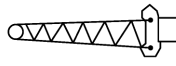

67ft Offset Fly



102,000 lbs



Boom Length (ft)												
Fly Offset												
Radius (ft)	44.3				73.5				103.8			
	2°	15°	30°	45°	2°	15°	30°	45°	2°	15°	30°	45°
15	30,000											
20	27,800				27,500							
25	24,600	19,800			27,500				18,200			
30	21,100	18,100			21,400				18,200			
35	19,100	16,600			21,400	18,500			18,200			
40	17,400	15,400	13,700		21,100	17,300			18,200	18,100		
45	16,000	14,300	12,800		19,500	16,200	13,700		18,200	17,700		
50	14,800	13,300	12,100		18,100	15,300	13,100		18,200	16,800		
55	13,800	12,500	11,400	10,600	16,900	14,400	12,400		18,200	15,900	13,200	
60	12,800	11,700	10,800	10,100	15,800	13,600	11,900	10,700	18,200	15,200	12,700	
65	12,000	11,100	10,300	9,700	14,900	12,900	11,400	10,300	17,500	14,500	12,200	10,800
70	11,200	10,500	9,800	9,300	14,000	12,300	10,900	10,000	16,600	13,800	11,800	10,500
75	10,600	9,900	9,300	8,900	13,200	11,700	10,500	9,700	15,700	13,200	11,400	10,200
80	10,000	9,400	8,900	8,600	12,500	11,200	10,100	9,400	14,900	12,700	11,000	9,900
85	9,400	9,000	8,600	8,400	11,900	10,700	9,800	9,100	14,200	12,200	10,600	9,700
90	8,900	8,600	8,300	8,200	11,300	10,300	9,400	8,900	13,500	11,700	10,300	9,400
95	8,500	8,200	8,000		10,800	9,900	9,100	8,700	12,900	11,300	10,000	9,200
100	8,100	7,900			10,300	9,500	8,900	8,500	12,400	10,900	9,700	9,000
105					9,800	9,100	8,600	8,300	11,800	10,500	9,500	8,900
110					9,400	8,800	8,400	8,200	11,400	10,200	9,200	8,700
115					9,000	8,500	8,200	8,200	10,900	9,800	9,000	8,500
120					8,700	8,300	8,000		10,500	9,500	8,800	8,400
125					8,300	8,100	8,000		10,100	9,300	8,600	8,300
130									9,800	9,000	8,400	8,200
135									9,400	8,800	8,300	8,200
140									9,100	8,500	8,200	8,200
145									8,800	8,300	8,000	
150									8,500	8,100	8,000	
155									8,300	8,000		
Min Angle	0.0	0.0	0.0	0.0	14.0	18.5	0.0	0.0	15.5	18.5	27.0	11.5
Max Rad.	102.9	102.7	100.7	96.8	130.0	130.0	128.9	123.9	160.0	160.0	155.0	146.4
Capacity	6,200	6,400	7,000	8,200	0	0	2,000	2,300	0	0	0	0

1071070



PORTLAND OFFICE: 503.283.3111
 SEATTLE OFFICE: 206.784.1054
WWW.NESSCAMPBELL.COM

Rated Lifting Capacities in Pounds

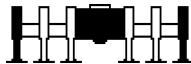

Full

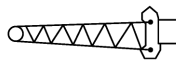

67ft Offset Fly

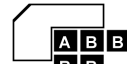

102,000 lbs



Radius (ft)	Boom Length (ft)											
	Fly Offset											
	134.9				167.1				183.6			
	2°	15°	30°	45°	2°	15°	30°	45°	2°	15°	30°	45°
30	15,900											
35	15,900				13,300							
40	15,900				13,300				12,400			
45	15,900	15,800			13,300				12,400			
50	15,900	15,800			13,300				12,400			
55	15,900	15,800			13,300	13,300			12,400			
60	15,900	15,800	13,300		13,300	13,300			12,400	12,300		
65	15,900	15,800	12,900		13,300	13,300			12,400	12,300		
70	15,900	15,100	12,400		13,300	13,300	13,000		12,400	12,300		
75	15,900	14,500	12,100	10,500	13,300	13,300	12,600		12,400	12,300	12,300	
80	15,900	14,000	11,700	10,300	13,300	13,300	12,300	10,600	12,400	12,300	12,300	
85	15,900	13,500	11,400	10,100	13,300	13,300	12,000	10,400	12,400	12,300	12,200	
90	15,700	13,000	11,100	9,800	13,300	13,300	11,600	10,200	12,400	12,300	11,900	10,300
95	15,000	12,600	10,800	9,600	13,300	13,300	11,400	10,000	12,400	12,300	11,600	10,100
100	14,400	12,100	10,500	9,500	13,300	13,300	11,100	9,800	12,400	12,300	11,400	10,000
105	13,800	11,700	10,200	9,300	13,300	12,900	10,800	9,600	12,400	12,300	11,100	9,800
110	13,300	11,400	10,000	9,100	13,300	12,500	10,600	9,500	12,400	12,300	10,900	9,600
115	12,800	11,000	9,700	9,000	13,300	12,100	10,400	9,300	12,400	12,300	10,600	9,500
120	12,300	10,700	9,500	8,800	13,300	11,800	10,100	9,200	12,400	12,300	10,400	9,300
125	11,900	10,400	9,300	8,700	13,000	11,500	9,900	9,000	12,400	12,000	10,200	9,200
130	11,400	10,100	9,100	8,600	12,300	11,200	9,700	8,900	12,400	11,600	10,000	9,100
135	11,100	9,900	8,900	8,500	11,600	10,900	9,500	8,800	12,400	11,400	9,800	9,000
140	10,700	9,600	8,800	8,400	11,000	10,600	9,400	8,700	12,000	11,100	9,600	8,900
145	10,300	9,400	8,600	8,300	10,400	10,300	9,200	8,600	11,400	10,800	9,500	8,700
150	9,800	9,100	8,500	8,200	9,800	10,000	9,000	8,500	10,800	10,600	9,300	8,600
155	9,300	8,900	8,300	8,200	9,300	9,500	8,900	8,400	10,300	10,300	9,200	8,600
160	8,900	8,700	8,200	8,100	8,800	9,000	8,800	8,300	9,800	9,900	9,000	8,500
165	8,400	8,500	8,100	8,100	8,300	8,500	8,600	8,300	9,300	9,400	8,900	8,400
170	8,000	8,100	8,000		7,800	8,100	8,300	8,200	8,800	9,000	8,800	8,300
175	7,700	7,700	7,800		7,400	7,600	7,800	7,900	8,300	8,500	8,600	8,300
180	7,300	7,400	7,400		7,000	7,200	7,400	7,500	7,900	8,100	8,300	8,200
185	7,000	7,000			6,600	6,800	7,000	7,000	7,500	7,700	7,800	7,900
190					6,300	6,400	6,600	6,600	7,200	7,300	7,500	7,500
195					5,900	6,100	6,200		6,800	6,900	7,100	7,100
200					5,600	5,700	5,800		6,400	6,600	6,700	6,800
205					5,300	5,400	5,500		5,900	6,300	6,400	6,400
210					5,000	5,100	5,200		5,500	5,800	6,000	
215					4,700	4,800			5,000	5,300	5,600	
220					4,500				4,600	4,900	5,000	
225									4,200	4,400	4,500	
230									3,800	4,000	4,100	
235									3,500	3,600		
Min Angle	17.5	20.0	27.0	14.5	10.0	22.5	13.5	14.0	15.0	16.0	21.5	22.0
Max Rad.	190.0	190.0	185.0	177.6	225.0	220.0	218.7	209.7	240.0	240.0	235.0	226.3
Capacity	0	0	0	0	0	0	0	0	0	0	0	0

1071070



PORTLAND OFFICE: 503.283.3111
 SEATTLE OFFICE: 206.784.1054
WWW.NESSCAMPBELL.COM

Rated Lifting Capacities in Pounds

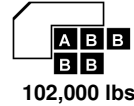
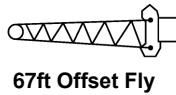
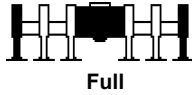

Radius (ft)	Boom Length (ft)			
	Fly Offset			
	200.1			
	2°	15°	30°	45°
45	10,800			
50	10,800			
55	10,800			
60	10,800			
65	10,800	10,800		
70	10,800	10,800		
75	10,800	10,800		
80	10,800	10,800	10,700	
85	10,800	10,800	10,700	
90	10,800	10,800	10,700	
95	10,800	10,800	10,700	10,300
100	10,800	10,800	10,700	10,100
105	10,800	10,800	10,700	9,900
110	10,800	10,800	10,700	9,800
115	10,800	10,800	10,700	9,600
120	10,800	10,800	10,700	9,500
125	10,800	10,800	10,500	9,400
130	10,800	10,800	10,300	9,200
135	10,800	10,800	10,100	9,100
140	10,800	10,800	9,900	9,000
145	10,800	10,800	9,700	8,900
150	10,800	10,800	9,600	8,800
155	10,800	10,800	9,400	8,700
160	10,600	10,500	9,300	8,600
165	10,000	10,300	9,100	8,500
170	9,200	9,800	9,000	8,400
175	8,500	9,200	8,900	8,400
180	7,800	8,500	8,700	8,300
185	7,200	7,900	8,400	8,300
190	6,600	7,200	7,800	8,100
195	6,100	6,600	7,100	7,400
200	5,500	6,100	6,500	6,700
205	5,000	5,500	5,900	6,100
210	4,600	5,000	5,400	5,500
215	4,100	4,500	4,900	5,000
220	3,700	4,100	4,400	4,400
225	3,300	3,600	3,900	
230	2,900	3,200	3,400	
235	2,500	2,800	3,000	
240	2,200	2,400	2,500	
245		2,100	2,100	
Min Angle	27.5	27.5	27.0	26.5
Max Rad. Capacity	243.3	246.3	246.3	242.5
	0	0	0	0

1071070



PORTLAND OFFICE: 503.283.3111
 SEATTLE OFFICE: 206.784.1054
WWW.NESSCAMPBELL.COM

Rated Lifting Capacities in Pounds

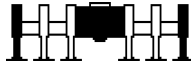

Full

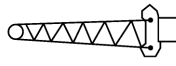

67ft Offset Fly

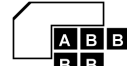

102,000 lbs



Radius (ft)	Boom Length (ft)											
	Fly Offset											
	44.3				58.9				89.1			
	2°	15°	30°	45°	2°	15°	30°	45°	2°	15°	30°	45°
15	30,000											
20	27,800				30,000				28,400			
25	24,600	19,800			26,900				28,400			
30	21,100	18,100			24,100	19,100			28,100			
35	19,100	16,600			21,100	17,700			25,600	19,300		
40	17,400	15,400	13,700		19,300	16,400			23,500	18,100		
45	16,000	14,300	12,800		17,800	15,300	13,300		21,100	17,000		
50	14,800	13,300	12,100		16,500	14,400	12,600		19,700	16,100	13,400	
55	13,800	12,500	11,400	10,600	15,400	13,500	12,000	10,900	18,400	15,200	12,900	
60	12,800	11,700	10,800	10,100	14,400	12,700	11,400	10,400	17,300	14,500	12,300	10,900
65	12,000	11,100	10,300	9,700	13,500	12,100	10,900	10,000	16,300	13,800	11,800	10,600
70	11,200	10,500	9,800	9,300	12,700	11,400	10,400	9,700	15,300	13,100	11,400	10,300
75	10,600	9,900	9,300	8,900	11,900	10,900	10,000	9,300	14,500	12,500	11,000	10,000
80	10,000	9,400	8,900	8,600	11,300	10,400	9,600	9,000	13,800	12,000	10,600	9,700
85	9,400	9,000	8,600	8,400	10,700	9,900	9,200	8,800	13,100	11,500	10,200	9,400
90	8,900	8,600	8,300	8,200	10,200	9,500	8,900	8,600	12,500	11,100	9,900	9,200
95	8,500	8,200	8,000		9,700	9,100	8,600	8,400	11,900	10,600	9,600	9,000
100	8,100	7,900			9,200	8,700	8,300	8,200	11,400	10,200	9,300	8,800
105					8,800	8,400	8,100		10,900	9,900	9,100	8,600
110					8,400	8,100	8,000		10,400	9,500	8,800	8,500
115					8,100	7,900			10,000	9,200	8,600	8,300
120									9,600	8,900	8,400	8,200
125									9,300	8,700	8,300	8,200
130									8,900	8,400	8,100	
135									8,600	8,200	8,000	
140									8,300	8,000	8,000	
145									8,100	7,900		
Min Angle	0.0	0.0	0.0	0.0	0.0	0.0	0.0	0.0	0.0	0.0	0.0	0.0
Max Rad.	102.9	102.7	100.7	96.8	117.5	117.1	114.7	110.2	147.7	147.1	144.1	138.7
Capacity	6,200	6,400	7,000	8,200	3,600	3,700	4,100	4,700	2,600	2,600	2,900	3,400

1071080



PORTLAND OFFICE: 503.283.3111
 SEATTLE OFFICE: 206.784.1054
WWW.NESSCAMPBELL.COM

Rated Lifting Capacities in Pounds

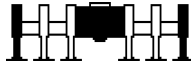

Full

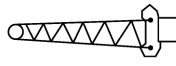

67ft Offset Fly



102,000 lbs



Radius (ft)	Boom Length (ft)											
	Fly Offset											
	120.3				152.4				169.0			
	2°	15°	30°	45°	2°	15°	30°	45°	2°	15°	30°	45°
25	19,500											
30	19,500											
35	19,500				16,600				15,500			
40	19,500				16,600				15,500			
45	19,500	18,400			16,600				15,500			
50	19,500	17,500			16,600	16,500			15,500			
55	19,500	16,600	13,500		16,600	16,500			15,500	15,500		
60	19,500	15,900	13,000		16,600	16,500			15,500	15,500		
65	18,900	15,200	12,600		16,600	16,400	13,100		15,500	15,500		
70	17,900	14,500	12,200	10,700	16,600	15,800	12,700		15,500	15,500	13,000	
75	17,000	14,000	11,800	10,400	16,600	15,200	12,400	10,700	15,500	15,500	12,600	
80	16,100	13,400	11,400	10,100	16,600	14,600	12,000	10,500	15,500	15,200	12,300	
85	15,400	12,900	11,100	9,900	16,600	14,100	11,700	10,200	15,500	14,700	12,000	10,400
90	14,700	12,400	10,700	9,700	16,600	13,600	11,400	10,000	15,500	14,200	11,700	10,200
95	14,000	12,000	10,400	9,500	16,100	13,200	11,100	9,800	15,500	13,700	11,400	10,000
100	13,400	11,600	10,200	9,300	15,400	12,800	10,800	9,700	15,500	13,300	11,100	9,800
105	12,900	11,200	9,900	9,100	14,800	12,400	10,600	9,500	15,500	12,900	10,900	9,700
110	12,400	10,800	9,600	8,900	14,300	12,000	10,300	9,300	15,200	12,500	10,600	9,500
115	11,900	10,500	9,400	8,800	13,700	11,600	10,100	9,200	14,600	12,200	10,400	9,300
120	11,500	10,200	9,200	8,600	13,300	11,300	9,900	9,000	14,100	11,800	10,200	9,200
125	11,100	9,900	9,000	8,500	12,800	11,000	9,700	8,900	13,600	11,500	10,000	9,100
130	10,700	9,600	8,800	8,400	12,400	10,700	9,500	8,800	13,200	11,200	9,800	8,900
135	10,300	9,300	8,600	8,300	12,000	10,400	9,300	8,700	12,800	10,900	9,600	8,800
140	10,000	9,100	8,500	8,200	11,300	10,200	9,100	8,500	12,400	10,700	9,400	8,700
145	9,600	8,900	8,300	8,200	10,700	9,900	8,900	8,500	11,800	10,400	9,200	8,600
150	9,300	8,700	8,200	8,200	10,200	9,700	8,800	8,400	11,200	10,200	9,100	8,500
155	9,100	8,500	8,100		9,600	9,400	8,600	8,300	10,700	9,900	8,900	8,400
160	8,800	8,300	8,000		9,100	9,200	8,500	8,200	10,200	9,700	8,800	8,300
165	8,500	8,100	8,000		8,600	8,800	8,400	8,200	9,700	9,500	8,700	8,300
170	8,300	8,000			8,200	8,400	8,300	8,100	9,200	9,300	8,500	8,200
175					7,800	7,900	8,100	8,100	8,700	8,900	8,400	8,200
180					7,400	7,500	7,600	7,700	8,300	8,500	8,300	8,100
185					7,000	7,100	7,200		7,900	8,100	8,200	8,100
190					6,600	6,700	6,800		7,300	7,700	7,800	7,800
195					6,300	6,400	6,400		6,700	7,100	7,400	7,400
200					5,900	6,000	6,100		6,200	6,600	6,800	
205					5,600	5,700			5,700	6,000	6,200	
210									5,200	5,500	5,700	
215									4,800	5,000	5,100	
220									4,400	4,500		
Min Angle	18.0	20.5	28.0	3.5	12.0	7.5	11.0	30.5	15.0	17.0	22.5	19.5
Max Rad.	175.0	175.0	170.0	163.0	210.0	209.5	204.1	195.0	225.0	225.0	220.0	211.7
Capacity	0	0	0	0	0	0	0	0	0	0	0	0

1071080



PORTLAND OFFICE: 503.283.3111
 SEATTLE OFFICE: 206.784.1054
WWW.NESSCAMPBELL.COM

Rated Lifting Capacities in Pounds

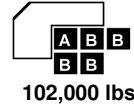
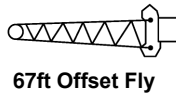
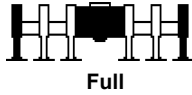

Radius (ft)	Boom Length (ft)			
	Fly Offset			
	185.5			
	2°	15°	30°	45°
40	13,500			
45	13,500			
50	13,500			
55	13,500			
60	13,500	13,500		
65	13,500	13,500		
70	13,500	13,500		
75	13,500	13,500	12,900	
80	13,500	13,500	12,500	
85	13,500	13,500	12,200	
90	13,500	13,500	11,900	10,300
95	13,500	13,500	11,700	10,100
100	13,500	13,500	11,400	10,000
105	13,500	13,400	11,100	9,800
110	13,500	13,000	10,900	9,600
115	13,500	12,700	10,700	9,500
120	13,500	12,300	10,500	9,400
125	13,500	12,000	10,200	9,200
130	13,500	11,700	10,000	9,100
135	13,500	11,400	9,900	9,000
140	13,100	11,100	9,700	8,900
145	12,700	10,900	9,500	8,800
150	12,200	10,600	9,400	8,700
155	11,400	10,400	9,200	8,600
160	10,500	10,200	9,100	8,500
165	9,700	9,900	8,900	8,400
170	8,900	9,700	8,800	8,300
175	8,200	8,900	8,700	8,300
180	7,500	8,200	8,500	8,200
185	6,900	7,500	8,100	8,200
190	6,300	6,900	7,400	7,600
195	5,800	6,300	6,700	6,900
200	5,200	5,700	6,100	6,300
205	4,700	5,200	5,500	5,600
210	4,300	4,700	5,000	
215	3,800	4,200	4,400	
220	3,400	3,700	3,900	
225	3,000	3,300	3,400	
230	2,600	2,900	2,900	
235	2,300	2,400		
Min Angle	17.5	19.0	24.0	19.0
Max Rad.	240.0	240.0	235.0	228.2
Capacity	0	0	0	0

1071080



PORTLAND OFFICE: 503.283.3111
 SEATTLE OFFICE: 206.784.1054
WWW.NESSCAMPBELL.COM

Rated Lifting Capacities in Pounds

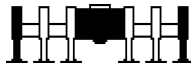

Full

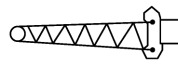

67ft Offset Fly

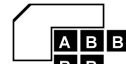

102,000 lbs



Radius (ft)	Boom Length (ft)											
	Fly Offset											
	44.3				73.5				103.8			
	2°	15°	30°	45°	2°	15°	30°	45°	2°	15°	30°	45°
15	30,000											
20	27,800				27,500							
25	24,600	19,800			27,500							
30	21,100	18,100			21,400				18,200			
35	19,100	16,600			21,400	18,500			18,200			
40	17,400	15,400	13,700		21,100	17,300			18,200			
45	16,000	14,300	12,800		19,500	16,200	13,700		18,200	17,700		
50	14,800	13,300	12,100		18,100	15,300	13,100		18,200	16,800		
55	13,800	12,500	11,400	10,600	16,900	14,400	12,400		18,200	15,900	13,200	
60	12,800	11,700	10,800	10,100	15,800	13,600	11,900	10,700	18,200	15,200	12,700	
65	12,000	11,100	10,300	9,700	14,900	12,900	11,400	10,300	17,500	14,500	12,200	10,800
70	11,200	10,500	9,800	9,300	14,000	12,300	10,900	10,000	16,600	13,800	11,800	10,500
75	10,600	9,900	9,300	8,900	13,200	11,700	10,500	9,700	15,700	13,200	11,400	10,200
80	10,000	9,400	8,900	8,600	12,500	11,200	10,100	9,400	14,900	12,700	11,000	9,900
85	9,400	9,000	8,600	8,400	11,900	10,700	9,800	9,100	14,200	12,200	10,600	9,700
90	8,900	8,600	8,300	8,200	11,300	10,300	9,400	8,900	13,500	11,700	10,300	9,400
95	8,500	8,200	8,000		10,800	9,900	9,100	8,700	12,900	11,300	10,000	9,200
100	8,100	7,900			10,300	9,500	8,900	8,500	12,400	10,900	9,700	9,000
105					9,800	9,100	8,600	8,300	11,800	10,500	9,500	8,900
110					9,400	8,800	8,400	8,200	11,400	10,200	9,200	8,700
115					9,000	8,500	8,200	8,200	10,900	9,800	9,000	8,500
120					8,700	8,300	8,000		10,500	9,500	8,800	8,400
125					8,300	8,100	8,000		10,100	9,300	8,600	8,300
130									9,800	9,000	8,400	8,200
135									9,400	8,800	8,300	8,200
140									9,100	8,500	8,200	8,200
145									8,800	8,300	8,000	
150									8,500	8,100	8,000	
155									8,300	8,000		
Min Angle	0.0	0.0	0.0	0.0	14.0	18.5	0.0	0.0	15.5	18.5	27.0	11.5
Max Rad.	102.9	102.7	100.7	96.8	130.0	130.0	128.9	123.9	160.0	160.0	155.0	146.4
Capacity	6,200	6,400	7,000	8,200	0	0	2,000	2,300	0	0	0	0

1071090



PORTLAND OFFICE: 503.283.3111
 SEATTLE OFFICE: 206.784.1054
WWW.NESSCAMPBELL.COM

Rated Lifting Capacities in Pounds

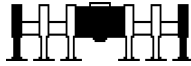

Full

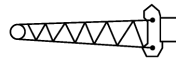

67ft Offset Fly



102,000 lbs



Radius (ft)	Boom Length (ft)											
	Fly Offset											
	119.4				135.4				152.0			
	2°	15°	30°	45°	2°	15°	30°	45°	2°	15°	30°	45°
30	17,800											
35	17,800				18,100				17,400			
40	17,800				18,100				17,400			
45	17,800				18,100	18,000			17,400			
50	17,800	17,400			18,100	18,000			17,400	17,300		
55	17,800	16,600			18,100	17,200			17,400	17,300		
60	17,800	15,800	13,000		18,100	16,500	13,300		17,400	17,100		
65	17,800	15,200	12,600		18,100	15,800	12,900		17,400	16,400	13,100	
70	17,800	14,500	12,100	10,600	18,100	15,100	12,500		17,400	15,700	12,700	
75	16,900	13,900	11,700	10,400	18,000	14,500	12,100	10,500	17,400	15,200	12,400	10,700
80	16,100	13,400	11,400	10,100	17,200	14,000	11,700	10,300	17,400	14,600	12,000	10,500
85	15,300	12,900	11,000	9,900	16,400	13,500	11,400	10,100	17,400	14,100	11,700	10,200
90	14,600	12,400	10,700	9,700	15,700	13,000	11,100	9,900	16,700	13,600	11,400	10,000
95	14,000	12,000	10,400	9,400	15,000	12,600	10,800	9,600	16,000	13,200	11,100	9,800
100	13,400	11,500	10,100	9,300	14,400	12,200	10,500	9,500	15,400	12,700	10,800	9,600
105	12,800	11,200	9,900	9,100	13,800	11,800	10,200	9,300	14,800	12,400	10,600	9,500
110	12,300	10,800	9,600	8,900	13,300	11,400	10,000	9,100	14,200	12,000	10,300	9,300
115	11,900	10,500	9,400	8,800	12,800	11,100	9,700	9,000	13,700	11,600	10,100	9,200
120	11,400	10,200	9,200	8,600	12,300	10,700	9,500	8,800	13,200	11,300	9,900	9,000
125	11,000	9,900	9,000	8,500	11,900	10,400	9,300	8,700	12,800	11,000	9,600	8,900
130	10,600	9,600	8,800	8,400	11,500	10,100	9,100	8,600	12,300	10,700	9,500	8,800
135	10,300	9,300	8,600	8,300	11,100	9,900	8,900	8,500	11,900	10,400	9,300	8,700
140	9,900	9,100	8,500	8,200	10,700	9,600	8,800	8,400	11,600	10,100	9,100	8,500
145	9,600	8,800	8,300	8,200	10,400	9,400	8,600	8,300	11,200	9,900	8,900	8,500
150	9,300	8,600	8,200	8,200	10,100	9,100	8,500	8,200	10,900	9,700	8,800	8,400
155	9,000	8,400	8,100		9,800	8,900	8,300	8,200	10,500	9,400	8,600	8,300
160	8,700	8,300	8,000		9,500	8,700	8,200	8,100	10,200	9,200	8,500	8,200
165	8,500	8,100	8,000		9,200	8,500	8,100	8,100	9,900	9,000	8,400	8,200
170	8,300	8,000			9,000	8,400	8,000		9,700	8,800	8,300	8,100
175					8,700	8,200	8,000		9,400	8,700	8,200	8,100
180					8,500	8,100	8,000		9,200	8,500	8,100	8,100
185					8,300	8,000			8,900	8,300	8,000	
190									8,400	8,200	8,000	
195									7,900	8,100	8,000	
200									7,400	7,600		
205									6,900			
Min Angle	16.5	19.5	27.0	12.5	18.0	20.5	27.0	12.5	8.5	21.5	9.0	10.0
Max Rad. Capacity	175.0	175.0	170.0	162.0	190.0	190.0	185.0	178.1	210.0	205.0	203.6	194.6
	0	0	0	0	0	0	0	0	0	0	0	0

1071090



PORTLAND OFFICE: 503.283.3111
 SEATTLE OFFICE: 206.784.1054
WWW.NESSCAMPBELL.COM

Rated Lifting Capacities in Pounds

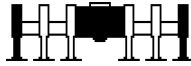

Full

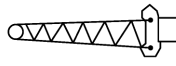

67ft Offset Fly



102,000 lbs



Radius (ft)	Boom Length (ft)			
	Fly Offset			
	168.5			
	2°	15°	30°	45°
35	15,300			
40	15,300			
45	15,300			
50	15,300			
55	15,300	15,200		
60	15,300	15,200		
65	15,300	15,200		
70	15,300	15,200	13,000	
75	15,300	15,200	12,600	
80	15,300	15,200	12,300	
85	15,300	14,600	12,000	10,400
90	15,300	14,200	11,700	10,200
95	15,300	13,700	11,400	10,000
100	15,300	13,300	11,100	9,800
105	15,300	12,900	10,900	9,600
110	15,200	12,500	10,600	9,500
115	14,600	12,200	10,400	9,300
120	14,100	11,800	10,200	9,200
125	13,600	11,500	10,000	9,100
130	13,200	11,200	9,800	8,900
135	12,700	10,900	9,600	8,800
140	12,400	10,600	9,400	8,700
145	12,000	10,400	9,200	8,600
150	11,600	10,100	9,100	8,500
155	11,300	9,900	8,900	8,400
160	10,900	9,700	8,800	8,300
165	10,600	9,500	8,700	8,300
170	9,900	9,300	8,500	8,200
175	9,200	9,100	8,400	8,200
180	8,500	8,900	8,300	8,100
185	7,900	8,400	8,200	8,100
190	7,300	7,800	8,100	8,100
195	6,800	7,200	7,500	
200	6,300	6,600	6,900	
205	5,800	6,100	6,300	
210	5,300	5,600	5,700	
215	4,900	5,100	5,100	
220	4,400	4,600		
Min Angle	14.0	15.5	21.5	20.0
Max Rad.	225.0	225.0	220.0	211.2
Capacity	0	0	0	0

1071090



PORTLAND OFFICE: 503.283.3111
 SEATTLE OFFICE: 206.784.1054
WWW.NESSCAMPBELL.COM

Rated Lifting Capacities in Pounds

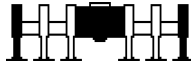

Full

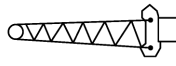

67ft Hydraulic Offset Fly



102,000 lbs



Radius (ft)	Boom Length (ft)											
	Fly Offset											
	44.3			73.5			103.8			134.9		
	2°-15°	15°-30°	30°-45°	2°-15°	15°-30°	30°-45°	2°-15°	15°-30°	30°-45°	2°-15°	15°-30°	30°-45°
15	30,000											
20	27,800			27,500								
25	19,800	19,800		27,500			18,200					
30	18,100	18,100		19,900	19,900		18,200			15,900		
35	16,600	16,600		18,500	18,500		18,200			15,900		
40	15,400	13,700	13,700	17,300	17,300		18,100	18,100		15,900		
45	14,300	12,800	12,800	16,200	13,700	13,700	17,700	17,700		15,800	15,800	
50	13,300	12,100	11,100	15,300	13,100	13,100	16,800	13,800	13,800	15,800	15,800	
55	12,500	11,400	10,600	14,400	12,400	11,100	15,900	13,200	13,200	15,800	15,800	
60	11,700	10,800	10,100	13,600	11,900	10,700	15,200	12,700	12,700	15,800	13,300	13,300
65	11,100	10,300	9,700	12,900	11,400	10,300	14,500	12,200	10,800	15,800	12,900	12,900
70	10,500	9,800	9,300	12,300	10,900	10,000	13,800	11,800	10,500	15,100	12,400	10,800
75	9,900	9,300	8,900	11,700	10,500	9,700	13,200	11,400	10,200	14,500	12,100	10,500
80	9,400	8,900	8,600	11,200	10,100	9,400	12,700	11,000	9,900	14,000	11,700	10,300
85	9,000	8,600	8,400	10,700	9,800	9,100	12,200	10,600	9,700	13,500	11,400	10,100
90	8,600	8,300	8,200	10,300	9,400	8,900	11,700	10,300	9,400	13,000	11,100	9,800
95	8,200	8,000	8,000	9,900	9,100	8,700	11,300	10,000	9,200	12,600	10,800	9,600
100	7,900	7,900		9,500	8,900	8,500	10,900	9,700	9,000	12,100	10,500	9,500
105				9,100	8,600	8,300	10,500	9,500	8,900	11,700	10,200	9,300
110				8,800	8,400	8,200	10,200	9,200	8,700	11,400	10,000	9,100
115				8,500	8,200	8,200	9,800	9,000	8,500	11,000	9,700	9,000
120				8,300	8,000	8,000	9,500	8,800	8,400	10,700	9,500	8,800
125				8,100	8,000	8,000	9,300	8,600	8,300	10,400	9,300	8,700
130							9,000	8,400	8,200	10,100	9,100	8,600
135							8,800	8,300	8,200	9,900	8,900	8,500
140							8,500	8,200	8,200	9,600	8,800	8,400
145							8,300	8,000	8,000	9,400	8,600	8,300
150							8,100	8,000		9,100	8,500	8,200
155							8,000			8,900	8,300	8,200
160										8,700	8,200	8,100
165										8,400	8,100	8,100
170										8,000	8,000	8,000
175										7,700	7,700	7,800
180										7,300	7,400	
185										7,000		
Min Angle	0.0	0.0	0.0	14.0	18.5	0.0	15.5	27.0	11.5	17.5	27.0	14.5
Max Rad. Capacity	102.9	102.7	100.7	130.0	130.0	128.9	160.0	155.0	146.4	190.0	185.0	177.6
	6,200	6,400	7,000	0	0	2,000	0	0	0	0	0	0

1072070



PORTLAND OFFICE: 503.283.3111
 SEATTLE OFFICE: 206.784.1054
WWW.NESSCAMPBELL.COM

Rated Lifting Capacities in Pounds

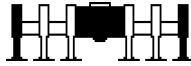

Full

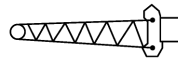

67ft Hydraulic Offset Fly



102,000 lbs



Radius (ft)	Boom Length (ft)								
	Fly Offset								
	167.1			183.6			200.1		
	2°-15°	15°-30°	30°-45°	2°-15°	15°-30°	30°-45°	2°-15°	15°-30°	30°-45°
35	13,300								
40	13,300			12,400					
45	13,300			12,400			10,800		
50	13,200	13,200		12,400			10,800		
55	13,200	13,200		12,300	12,300		10,800		
60	13,200	13,200		12,300	12,300		10,800	10,800	
65	13,200	13,200	13,200	12,300	12,300		10,800	10,800	
70	13,200	13,000	13,000	12,300	12,200	12,200	10,800	10,800	
75	13,200	12,600	12,600	12,300	12,200	12,200	10,800	10,700	10,700
80	13,200	12,300	10,600	12,300	12,200	12,200	10,800	10,700	10,700
85	13,200	12,000	10,400	12,300	12,200	10,500	10,800	10,700	10,700
90	13,200	11,600	10,200	12,300	11,900	10,300	10,800	10,700	10,400
95	13,200	11,400	10,000	12,300	11,600	10,100	10,800	10,700	10,300
100	13,200	11,100	9,800	12,300	11,400	10,000	10,800	10,700	10,100
105	12,900	10,800	9,600	12,300	11,100	9,800	10,800	10,700	9,900
110	12,500	10,600	9,500	12,300	10,900	9,600	10,800	10,700	9,800
115	12,100	10,400	9,300	12,300	10,600	9,500	10,800	10,700	9,600
120	11,800	10,100	9,200	12,300	10,400	9,300	10,800	10,700	9,500
125	11,500	9,900	9,000	12,000	10,200	9,200	10,800	10,500	9,400
130	11,200	9,700	8,900	11,600	10,000	9,100	10,800	10,300	9,200
135	10,900	9,500	8,800	11,400	9,800	9,000	10,800	10,100	9,100
140	10,600	9,400	8,700	11,100	9,600	8,900	10,800	9,900	9,000
145	10,300	9,200	8,600	10,800	9,500	8,700	10,800	9,700	8,900
150	9,800	9,000	8,500	10,600	9,300	8,600	10,800	9,600	8,800
155	9,300	8,900	8,400	10,300	9,200	8,600	10,800	9,400	8,700
160	8,800	8,800	8,300	9,800	9,000	8,500	10,500	9,300	8,600
165	8,300	8,500	8,300	9,300	8,900	8,400	10,000	9,100	8,500
170	7,800	8,100	8,200	8,800	8,800	8,300	9,200	9,000	8,400
175	7,400	7,600	7,800	8,300	8,500	8,300	8,500	8,900	8,400
180	7,000	7,200	7,400	7,900	8,100	8,200	7,800	8,500	8,300
185	6,600	6,800	7,000	7,500	7,700	7,800	7,200	7,900	8,300
190	6,300	6,400	6,600	7,200	7,300	7,500	6,600	7,200	7,800
195	5,900	6,100	6,200	6,800	6,900	7,100	6,100	6,600	7,100
200	5,600	5,700	5,800	6,400	6,600	6,700	5,500	6,100	6,500
205	5,300	5,400	5,400	5,900	6,300	6,400	5,000	5,500	5,900
210	5,000	5,100		5,500	5,800	6,000	4,600	5,000	5,400
215	4,700	4,800		5,000	5,300	5,500	4,100	4,500	4,900
220				4,600	4,900	4,900	3,700	4,100	4,400
225				4,200	4,400	4,300	3,300	3,600	3,900
230				3,800	4,000		2,900	3,200	3,300
235				3,500			2,500	2,800	2,800
240							2,200	2,400	2,300
245								2,100	
Min Angle	22.5	13.5	14.0	15.0	21.5	22.0	27.5	27.0	26.5
Max Rad. Capacity	220.0	218.7	209.7	240.0	235.0	226.3	243.3	246.3	242.5
	0	0	0	0	0	0	0	0	0

1072070



PORTLAND OFFICE: 503.283.3111
 SEATTLE OFFICE: 206.784.1054
WWW.NESSCAMPBELL.COM

Rated Lifting Capacities in Pounds

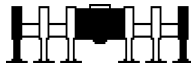

Full

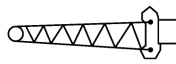

67ft Hydraulic Offset Fly

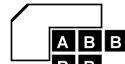

102,000 lbs



Radius (ft)	Boom Length (ft)											
	Fly Offset											
	44.3			58.9			89.1			120.3		
	2°-15°	15°-30°	30°-45°	2°-15°	15°-30°	30°-45°	2°-15°	15°-30°	30°-45°	2°-15°	15°-30°	30°-45°
15	30,000											
20	27,800			30,300			28,400					
25	19,800	19,800		26,900			28,400			19,500		
30	18,100	18,100		19,100	19,100		28,100			19,500		
35	16,600	16,600		17,700	17,700		19,300	19,300		19,500		
40	15,400	13,700	13,700	16,400	14,100	14,100	18,100	18,100		19,400	19,400	
45	14,300	12,800	12,800	15,300	13,300	13,300	17,000	14,100	14,100	18,400	18,400	
50	13,300	12,100	11,100	14,400	12,600	12,600	16,100	13,400	13,400	17,500	17,500	
55	12,500	11,400	10,600	13,500	12,000	10,900	15,200	12,900	12,900	16,600	13,500	13,500
60	11,700	10,800	10,100	12,700	11,400	10,400	14,500	12,300	10,900	15,900	13,000	13,000
65	11,100	10,300	9,700	12,100	10,900	10,000	13,800	11,800	10,600	15,200	12,600	10,900
70	10,500	9,800	9,300	11,400	10,400	9,700	13,100	11,400	10,300	14,500	12,200	10,700
75	9,900	9,300	8,900	10,900	10,000	9,300	12,500	11,000	10,000	14,000	11,800	10,400
80	9,400	8,900	8,600	10,400	9,600	9,000	12,000	10,600	9,700	13,400	11,400	10,100
85	9,000	8,600	8,400	9,900	9,200	8,800	11,500	10,200	9,400	12,900	11,100	9,900
90	8,600	8,300	8,200	9,500	8,900	8,600	11,100	9,900	9,200	12,400	10,700	9,700
95	8,200	8,000	8,000	9,100	8,600	8,400	10,600	9,600	9,000	12,000	10,400	9,500
100	7,900	7,900		8,700	8,300	8,200	10,200	9,300	8,800	11,600	10,200	9,300
105				8,400	8,100	8,100	9,900	9,100	8,600	11,200	9,900	9,100
110				8,100	8,000	8,000	9,500	8,800	8,500	10,800	9,600	8,900
115				7,900	7,900		9,200	8,600	8,300	10,500	9,400	8,800
120							8,900	8,400	8,200	10,200	9,200	8,600
125							8,700	8,300	8,200	9,900	9,000	8,500
130							8,400	8,100	8,100	9,600	8,800	8,400
135							8,200	8,000	8,000	9,300	8,600	8,300
140							8,000	8,000	8,000	9,100	8,500	8,200
145							7,900	7,900		8,900	8,300	8,200
150										8,700	8,200	8,200
155										8,500	8,100	8,100
160										8,300	8,000	8,000
165										8,100	8,000	
170										8,000		
Min Angle	0.0	0.0	0.0	0.0	0.0	0.0	0.0	0.0	0.0	18.0	28.0	3.5
Max Rad.	102.9	102.7	100.7	117.5	117.1	114.7	147.7	147.1	144.1	175.0	170.0	163.0
Capacity	6,200	6,400	7,000	3,600	3,700	4,100	2,600	2,600	2,900	0	0	0

1072080



PORTLAND OFFICE: 503.283.3111
 SEATTLE OFFICE: 206.784.1054
WWW.NESSCAMPBELL.COM

Rated Lifting Capacities in Pounds

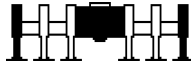

Full

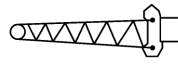

67ft Hydraulic Offset Fly



102,000 lbs



Radius (ft)	Boom Length (ft)								
	Fly Offset								
	152.4			169.0			185.5		
	2°-15°	15°-30°	30°-45°	2°-15°	15°-30°	30°-45°	2°-15°	15°-30°	30°-45°
35	16,600			15,500					
40	16,600			15,500			13,500		
45	16,600			15,500			13,500		
50	16,500	16,500		15,400	15,400		13,500		
55	16,500	16,500		15,400	15,400		13,500	13,500	
60	16,500	16,500		15,400	15,400		13,500	13,500	
65	16,400	13,100	13,100	15,400	13,400	13,400	13,500	13,500	
70	15,800	12,700	12,700	15,400	13,000	13,000	13,500	13,200	13,200
75	15,200	12,400	10,700	15,400	12,600	12,600	13,500	12,900	12,900
80	14,600	12,000	10,500	15,200	12,300	10,600	13,500	12,500	12,500
85	14,100	11,700	10,200	14,700	12,000	10,400	13,500	12,200	10,500
90	13,600	11,400	10,000	14,200	11,700	10,200	13,500	11,900	10,300
95	13,200	11,100	9,800	13,700	11,400	10,000	13,500	11,700	10,100
100	12,800	10,800	9,700	13,300	11,100	9,800	13,500	11,400	10,000
105	12,400	10,600	9,500	12,900	10,900	9,700	13,400	11,100	9,800
110	12,000	10,300	9,300	12,500	10,600	9,500	13,000	10,900	9,600
115	11,600	10,100	9,200	12,200	10,400	9,300	12,700	10,700	9,500
120	11,300	9,900	9,000	11,800	10,200	9,200	12,300	10,500	9,400
125	11,000	9,700	8,900	11,500	10,000	9,100	12,000	10,200	9,200
130	10,700	9,500	8,800	11,200	9,800	8,900	11,700	10,000	9,100
135	10,400	9,300	8,700	10,900	9,600	8,800	11,400	9,900	9,000
140	10,200	9,100	8,500	10,700	9,400	8,700	11,100	9,700	8,900
145	9,900	8,900	8,500	10,400	9,200	8,600	10,900	9,500	8,800
150	9,700	8,800	8,400	10,200	9,100	8,500	10,600	9,400	8,700
155	9,400	8,600	8,300	9,900	8,900	8,400	10,400	9,200	8,600
160	9,100	8,500	8,200	9,700	8,800	8,300	10,200	9,100	8,500
165	8,600	8,400	8,200	9,500	8,700	8,300	9,700	8,900	8,400
170	8,200	8,300	8,100	9,200	8,500	8,200	8,900	8,800	8,300
175	7,800	7,900	8,100	8,700	8,400	8,200	8,200	8,700	8,300
180	7,400	7,500	7,600	8,300	8,300	8,100	7,500	8,200	8,200
185	7,000	7,100	7,200	7,900	8,100	8,100	6,900	7,500	8,100
190	6,600	6,700	6,800	7,300	7,700	7,800	6,300	6,900	7,400
195	6,300	6,400		6,700	7,100	7,400	5,800	6,300	6,700
200	5,900	6,000		6,200	6,600	6,800	5,200	5,700	6,100
205	5,600			5,700	6,000	6,100	4,700	5,200	5,500
210				5,200	5,500	5,400	4,300	4,700	5,000
215				4,800	5,000		3,800	4,200	4,400
220				4,400			3,400	3,700	3,800
225							3,000	3,300	3,200
230							2,600	2,900	
235							2,300		

Min Angle	7.5	11.0	30.5	15.0	22.5	19.5	17.5	24.0	19.0
Max Rad. Capacity	209.5	204.1	195.0	225.0	220.0	211.7	240.0	235.0	228.2
	0	0	0	0	0	0	0	0	0

1072080



PORTLAND OFFICE: 503.283.3111
 SEATTLE OFFICE: 206.784.1054
WWW.NESSCAMPBELL.COM

Rated Lifting Capacities in Pounds

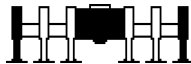

Full

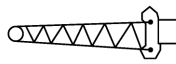

67ft Hydraulic Offset Fly

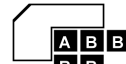

102,000 lbs



Radius (ft)	Boom Length (ft)											
	Fly Offset											
	44.3			73.5			103.8			119.4		
	2°-15°	15°-30°	30°-45°	2°-15°	15°-30°	30°-45°	2°-15°	15°-30°	30°-45°	2°-15°	15°-30°	30°-45°
15	30,000											
20	27,800			27,500								
25	19,800	19,800		27,500			18,200					
30	18,100	18,100		19,900	19,900		18,200			17,800		
35	16,600	16,600		18,500	18,500		18,200			17,800		
40	15,400	13,700	13,700	17,300	17,300		18,100	18,100		17,700	17,700	
45	14,300	12,800	12,800	16,200	13,700	13,700	17,700	17,700		17,700	17,700	
50	13,300	12,100	11,100	15,300	13,100	13,100	16,800	13,800	13,800	17,400	17,400	
55	12,500	11,400	10,600	14,400	12,400	11,100	15,900	13,200	13,200	16,600	13,500	13,500
60	11,700	10,800	10,100	13,600	11,900	10,700	15,200	12,700	12,700	15,800	13,000	13,000
65	11,100	10,300	9,700	12,900	11,400	10,300	14,500	12,200	10,800	15,200	12,600	12,600
70	10,500	9,800	9,300	12,300	10,900	10,000	13,800	11,800	10,500	14,500	12,100	10,600
75	9,900	9,300	8,900	11,700	10,500	9,700	13,200	11,400	10,200	13,900	11,700	10,400
80	9,400	8,900	8,600	11,200	10,100	9,400	12,700	11,000	9,900	13,400	11,400	10,100
85	9,000	8,600	8,400	10,700	9,800	9,100	12,200	10,600	9,700	12,900	11,000	9,900
90	8,600	8,300	8,200	10,300	9,400	8,900	11,700	10,300	9,400	12,400	10,700	9,700
95	8,200	8,000	8,000	9,900	9,100	8,700	11,300	10,000	9,200	12,000	10,400	9,400
100	7,900	7,900		9,500	8,900	8,500	10,900	9,700	9,000	11,500	10,100	9,300
105				9,100	8,600	8,300	10,500	9,500	8,900	11,200	9,900	9,100
110				8,800	8,400	8,200	10,200	9,200	8,700	10,800	9,600	8,900
115				8,500	8,200	8,200	9,800	9,000	8,500	10,500	9,400	8,800
120				8,300	8,000	8,000	9,500	8,800	8,400	10,200	9,200	8,600
125				8,100	8,000	8,000	9,300	8,600	8,300	9,900	9,000	8,500
130							9,000	8,400	8,200	9,600	8,800	8,400
135							8,800	8,300	8,200	9,300	8,600	8,300
140							8,500	8,200	8,200	9,100	8,500	8,200
145							8,300	8,000	8,000	8,800	8,300	8,200
150							8,100	8,000		8,600	8,200	8,200
155							8,000			8,400	8,100	8,100
160										8,300	8,000	8,000
165										8,100	8,000	
170										8,000		
Min Angle	0.0	0.0	0.0	14.0	18.5	0.0	15.5	27.0	11.5	16.5	27.0	12.5
Max Rad.	102.9	102.7	100.7	130.0	130.0	128.9	160.0	155.0	146.4	175.0	170.0	162.0
Capacity	6,200	6,400	7,000	0	0	2,000	0	0	0	0	0	0

1072090



PORTLAND OFFICE: 503.283.3111
 SEATTLE OFFICE: 206.784.1054
WWW.NESSCAMPBELL.COM

Rated Lifting Capacities in Pounds

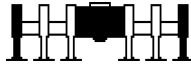

Full

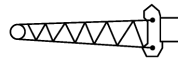

67ft Hydraulic Offset Fly



102,000 lbs



Radius (ft)	Boom Length (ft)								
	Fly Offset								
	135.4			152.0			168.5		
	2°-15°	15°-30°	30°-45°	2°-15°	15°-30°	30°-45°	2°-15°	15°-30°	30°-45°
35	18,100			17,400			15,300		
40	18,100			17,400			15,300		
45	18,000	18,000		17,400			15,300		
50	18,000	18,000		17,300	17,300		15,200	15,200	
55	17,200	17,200		17,300	17,300		15,200	15,200	
60	16,500	13,300	13,300	17,100	17,100		15,200	15,200	
65	15,800	12,900	12,900	16,400	13,100	13,100	15,200	15,200	
70	15,100	12,500	12,500	15,700	12,700	10,900	15,200	13,000	13,000
75	14,500	12,100	10,500	15,200	12,400	10,700	15,200	12,600	12,600
80	14,000	11,700	10,300	14,600	12,000	10,500	15,200	12,300	10,600
85	13,500	11,400	10,100	14,100	11,700	10,200	14,600	12,000	10,400
90	13,000	11,100	9,900	13,600	11,400	10,000	14,200	11,700	10,200
95	12,600	10,800	9,600	13,200	11,100	9,800	13,700	11,400	10,000
100	12,200	10,500	9,500	12,700	10,800	9,600	13,300	11,100	9,800
105	11,800	10,200	9,300	12,400	10,600	9,500	12,900	10,900	9,600
110	11,400	10,000	9,100	12,000	10,300	9,300	12,500	10,600	9,500
115	11,100	9,700	9,000	11,600	10,100	9,200	12,200	10,400	9,300
120	10,700	9,500	8,800	11,300	9,900	9,000	11,800	10,200	9,200
125	10,400	9,300	8,700	11,000	9,600	8,900	11,500	10,000	9,100
130	10,100	9,100	8,600	10,700	9,500	8,800	11,200	9,800	8,900
135	9,900	8,900	8,500	10,400	9,300	8,700	10,900	9,600	8,800
140	9,600	8,800	8,400	10,100	9,100	8,500	10,600	9,400	8,700
145	9,400	8,600	8,300	9,900	8,900	8,500	10,400	9,200	8,600
150	9,100	8,500	8,200	9,700	8,800	8,400	10,100	9,100	8,500
155	8,900	8,300	8,200	9,400	8,600	8,300	9,900	8,900	8,400
160	8,700	8,200	8,100	9,200	8,500	8,200	9,700	8,800	8,300
165	8,500	8,100	8,100	9,000	8,400	8,200	9,500	8,700	8,300
170	8,400	8,000	8,000	8,800	8,300	8,100	9,300	8,500	8,200
175	8,200	8,000	8,000	8,700	8,200	8,100	9,100	8,400	8,200
180	8,100	8,000		8,500	8,100	8,100	8,500	8,300	8,100
185	8,000			8,300	8,000	8,000	7,900	8,200	8,100
190				8,200	8,000	8,000	7,300	7,800	8,100
195				7,900	8,000		6,800	7,200	7,500
200				7,400	7,600		6,300	6,600	6,800
205							5,800	6,100	6,200
210							5,300	5,600	5,500
215							4,900	5,100	
220							4,400		
Min Angle	18.0	27.0	12.5	21.5	9.0	10.0	14.0	21.5	20.0
Max Rad.	190.0	185.0	178.1	205.0	203.6	194.6	225.0	220.0	211.2
Capacity	0	0	0	0	0	0	0	0	0

1072090



PORTLAND OFFICE: 503.283.3111
 SEATTLE OFFICE: 206.784.1054
WWW.NESSCAMPBELL.COM

Rated Lifting Capacities in Pounds

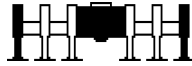

Full

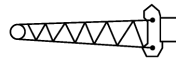

92ft Offset Fly



102,000 lbs



Radius (ft)	Boom Length (ft)											
	Fly Offset											
	44.3				73.5				103.8			
	2°	15°	30°	45°	2°	15°	30°	45°	2°	15°	30°	45°
20	19,800											
25	18,100				17,300							
30	16,700				17,300				15,200			
35	15,500	14,400			17,300				15,200			
40	14,400	13,400			16,300	14,600			15,200			
45	13,400	12,600	11,900		15,300	13,800			15,200	14,700		
50	12,600	11,800	11,200		14,400	13,100			15,200	14,000		
55	11,800	11,200	10,600		13,600	12,400	11,400		15,200	13,400		
60	11,100	10,500	10,000	9,700	12,900	11,800	10,900		14,400	12,800	11,500	
65	10,500	10,000	9,500	9,300	12,200	11,200	10,400	9,800	13,700	12,200	11,000	
70	9,900	9,500	9,100	8,800	11,600	10,700	10,000	9,400	13,100	11,700	10,600	9,800
75	9,400	9,000	8,700	8,400	11,000	10,200	9,500	9,100	12,500	11,300	10,200	9,500
80	8,900	8,600	8,300	8,100	10,500	9,800	9,200	8,700	12,000	10,800	9,900	9,200
85	8,400	8,100	7,800	7,700	10,000	9,400	8,800	8,400	11,500	10,400	9,500	8,900
90	7,900	7,700	7,400	7,300	9,600	9,000	8,500	8,200	11,000	10,000	9,200	8,700
95	7,400	7,200	7,100	7,000	9,200	8,700	8,200	7,900	10,600	9,700	8,900	8,400
100	7,000	6,800	6,700	6,600	8,800	8,300	7,800	7,600	10,200	9,300	8,600	8,200
105	6,500	6,400	6,300	6,300	8,400	7,900	7,500	7,300	9,800	9,000	8,400	8,000
110	6,100	6,000	6,000	6,000	8,000	7,600	7,200	7,000	9,400	8,700	8,100	7,700
115	5,800	5,700	5,700		7,600	7,200	6,900	6,800	9,100	8,400	7,800	7,500
120	5,400	5,400	5,400		7,200	6,900	6,600	6,500	8,800	8,100	7,600	7,300
125	5,100	5,100			6,800	6,500	6,300	6,300	8,400	7,800	7,300	7,100
130					6,500	6,200	6,100	6,100	8,100	7,500	7,100	6,900
135					6,100	6,000	5,800	5,900	7,700	7,200	6,800	6,700
140					5,800	5,700	5,600		7,400	6,900	6,600	6,400
145					5,600	5,500	5,400		7,000	6,700	6,400	6,300
150					5,300	5,200			6,700	6,400	6,200	6,100
155									6,400	6,200	6,000	5,900
160									6,200	5,900	5,800	5,800
165									5,900	5,700	5,600	
170									5,700	5,500	5,400	
175									5,500	5,300	5,300	
180									5,300	5,200		
Min Angle	0.0	0.0	0.0	0.0	14.0	17.0	26.5	26.0	15.5	17.5	25.0	22.5
Max Rad.	127.9	127.5	124.9	120.1	155.0	155.0	150.0	141.2	185.0	185.0	180.0	171.4
Capacity	3,100	3,100	3,400	3,900	0	0	0	0	0	0	0	0

1071100



PORTLAND OFFICE: 503.283.3111
 SEATTLE OFFICE: 206.784.1054
WWW.NESSCAMPBELL.COM

Rated Lifting Capacities in Pounds

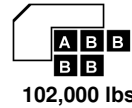
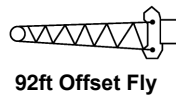
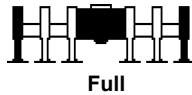

Radius (ft)	Boom Length (ft)											
	Fly Offset											
	134.9				167.1				183.6			
	2°	15°	30°	45°	2°	15°	30°	45°	2°	15°	30°	45°
35	12,900											
40	12,900											
45	12,900				10,400							
50	12,900				10,400				9,600			
55	12,900	12,800			10,400				9,600			
60	12,900	12,800			10,400	10,300			9,600			
65	12,900	12,800			10,400	10,300			9,600			
70	12,900	12,600	11,200		10,400	10,300			9,600	9,500		
75	12,900	12,200	10,800		10,400	10,300			9,600	9,500		
80	12,900	11,700	10,500	9,600	10,400	10,300	10,200		9,600	9,500		
85	12,800	11,300	10,100	9,300	10,400	10,300	10,200		9,600	9,500	9,400	
90	12,300	10,900	9,800	9,100	10,400	10,300	10,200	9,400	9,600	9,500	9,400	
95	11,800	10,600	9,500	8,900	10,400	10,300	10,100	9,200	9,600	9,500	9,400	9,300
100	11,400	10,200	9,300	8,600	10,400	10,300	9,800	9,000	9,600	9,500	9,400	9,100
105	11,000	9,900	9,000	8,400	10,400	10,300	9,500	8,800	9,600	9,500	9,400	9,000
110	10,600	9,600	8,800	8,200	10,400	10,300	9,300	8,600	9,600	9,500	9,400	8,800
115	10,300	9,300	8,500	8,000	10,400	10,100	9,100	8,400	9,600	9,500	9,300	8,600
120	9,900	9,000	8,300	7,800	10,400	9,800	8,900	8,300	9,600	9,500	9,100	8,400
125	9,600	8,800	8,100	7,600	10,400	9,600	8,700	8,100	9,600	9,500	8,900	8,300
130	9,300	8,500	7,900	7,400	10,400	9,300	8,500	7,900	9,600	9,500	8,700	8,100
135	9,000	8,300	7,600	7,300	10,000	9,100	8,300	7,700	9,600	9,400	8,500	8,000
140	8,700	8,000	7,400	7,100	9,800	8,800	8,100	7,600	9,600	9,200	8,300	7,800
145	8,400	7,700	7,200	6,900	9,300	8,600	7,900	7,400	9,600	9,000	8,200	7,600
150	8,100	7,500	7,000	6,700	8,800	8,400	7,700	7,200	9,600	8,800	8,000	7,500
155	7,800	7,200	6,800	6,600	8,300	8,200	7,500	7,100	9,100	8,600	7,800	7,300
160	7,500	7,000	6,600	6,400	7,800	7,900	7,300	7,000	8,600	8,300	7,600	7,200
165	7,200	6,800	6,400	6,300	7,300	7,600	7,100	6,800	8,200	8,100	7,400	7,000
170	6,900	6,500	6,200	6,100	6,900	7,200	7,000	6,700	7,700	7,900	7,300	6,900
175	6,500	6,300	6,000	6,000	6,500	6,800	6,800	6,500	7,300	7,500	7,100	6,800
180	6,200	6,100	5,900	5,900	6,100	6,400	6,600	6,400	6,900	7,100	6,900	6,600
185	5,900	5,900	5,700	5,800	5,700	6,000	6,200	6,300	6,500	6,700	6,800	6,500
190	5,500	5,700	5,600		5,300	5,600	5,800	5,900	6,100	6,300	6,600	6,400
195	5,200	5,400	5,400		5,000	5,200	5,400	5,600	5,800	6,000	6,200	6,300
200	5,000	5,100	5,100		4,700	4,900	5,100	5,200	5,400	5,600	5,800	5,900
205	4,700	4,800	4,800		4,400	4,600	4,800	4,800	5,100	5,300	5,500	5,600
210	4,500	4,500			4,100	4,300	4,400	4,500	4,800	5,000	5,200	5,200
215					3,800	4,000	4,100	4,100	4,500	4,700	4,900	4,900
220					3,500	3,700	3,800		4,200	4,400	4,500	4,600
225					3,300	3,400	3,500		4,000	4,100	4,300	4,300
230					3,000	3,200	3,200		3,600	3,900	4,000	4,000
235					2,800	2,900	3,000		3,300	3,600	3,700	
240					2,600	2,700			2,900	3,200	3,400	
245					2,400				2,600	2,800	3,000	
250									2,300	2,500	2,600	
255										2,100	2,200	
Min Angle	18.0	20.0	26.0	19.5	19.0	22.0	19.0	21.5	25.5	26.5	25.5	25.5
Max Rad.	215.0	215.0	210.0	202.6	245.8	245.0	243.7	234.7	255.0	256.7	257.0	251.3
Capacity	0	0	0	0	0	0	0	0	0	0	0	0

1071100



PORTLAND OFFICE: 503.283.3111
 SEATTLE OFFICE: 206.784.1054
WWW.NESSCAMPBELL.COM

Rated Lifting Capacities in Pounds

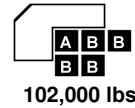
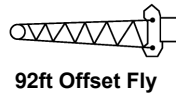
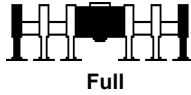

Radius (ft)	Boom Length (ft)			
	Fly Offset			
	200.1			
	2°	15°	30°	45°
55	8,200			
60	8,200			
65	8,200			
70	8,200			
75	8,200	8,100		
80	8,200	8,100		
85	8,200	8,100		
90	8,200	8,100	8,000	
95	8,200	8,100	8,000	
100	8,200	8,100	8,000	7,800
105	8,200	8,100	8,000	7,800
110	8,200	8,100	8,000	7,800
115	8,200	8,100	8,000	7,800
120	8,200	8,100	8,000	7,800
125	8,200	8,100	8,000	7,800
130	8,200	8,100	8,000	7,800
135	8,200	8,100	8,000	7,800
140	8,200	8,100	8,000	7,800
145	8,200	8,100	8,000	7,800
150	8,200	8,100	8,000	7,700
155	8,200	8,100	8,000	7,500
160	8,200	8,100	7,900	7,400
165	8,200	8,100	7,700	7,200
170	8,200	8,100	7,500	7,100
175	8,000	8,100	7,400	7,000
180	7,600	7,800	7,200	6,900
185	7,100	7,400	7,100	6,700
190	6,500	7,000	6,900	6,600
195	6,000	6,600	6,800	6,500
200	5,400	6,000	6,500	6,400
205	4,900	5,500	6,000	6,200
210	4,400	5,000	5,500	5,700
215	4,000	4,500	4,900	5,200
220	3,500	4,000	4,400	4,600
225	3,100	3,600	4,000	4,100
230	2,700	3,200	3,500	3,600
235	2,400	2,800	3,100	3,200
240		2,400	2,600	2,700
245			2,200	
Min Angle	41.0	41.5	41.0	41.0
Max Rad.	240.0	245.0	248.3	248.0
Capacity	0	0	0	0

1071100



PORTLAND OFFICE: 503.283.3111
 SEATTLE OFFICE: 206.784.1054
WWW.NESSCAMPBELL.COM

Rated Lifting Capacities in Pounds

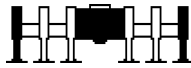

Full

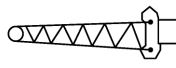

92ft Offset Fly



102,000 lbs



Boom Length (ft)												
Fly Offset												
Radius (ft)	44.3				58.9				89.1			
	2°	15°	30°	45°	2°	15°	30°	45°	2°	15°	30°	45°
20	19,800				19,700							
25	18,100				19,200				18,900			
30	16,700				17,700				18,900			
35	15,500	14,400			16,500	15,000			18,300			
40	14,400	13,400			15,400	14,100			17,100	15,100		
45	13,400	12,600	11,900		14,400	13,300			16,200	14,300		
50	12,600	11,800	11,200		13,500	12,500	11,600		15,300	13,600		
55	11,800	11,200	10,600		12,700	11,800	11,000		14,400	12,900	11,700	
60	11,100	10,500	10,000	9,700	12,000	11,200	10,500	10,000	13,700	12,300	11,200	
65	10,500	10,000	9,500	9,300	11,400	10,600	10,000	9,600	13,000	11,800	10,700	
70	9,900	9,500	9,100	8,800	10,800	10,100	9,600	9,200	12,400	11,300	10,300	9,700
75	9,400	9,000	8,700	8,400	10,200	9,600	9,100	8,800	11,800	10,800	9,900	9,300
80	8,900	8,600	8,300	8,100	9,700	9,200	8,700	8,400	11,300	10,400	9,600	9,000
85	8,400	8,100	7,800	7,700	9,300	8,800	8,400	8,100	10,800	9,900	9,200	8,700
90	7,900	7,700	7,400	7,300	8,900	8,400	8,000	7,800	10,300	9,600	8,900	8,400
95	7,400	7,200	7,100	7,000	8,400	8,000	7,700	7,500	9,900	9,200	8,600	8,200
100	7,000	6,800	6,700	6,600	8,000	7,600	7,300	7,200	9,500	8,900	8,300	7,900
105	6,500	6,400	6,300	6,300	7,500	7,200	7,000	6,900	9,200	8,500	8,000	7,700
110	6,100	6,000	6,000	6,000	7,100	6,800	6,600	6,600	8,800	8,200	7,700	7,400
115	5,800	5,700	5,700		6,700	6,500	6,300	6,300	8,400	7,900	7,400	7,200
120	5,400	5,400	5,400		6,300	6,200	6,000	6,000	8,000	7,600	7,200	7,000
125	5,100	5,100			6,000	5,800	5,800		7,700	7,200	6,900	6,700
130					5,700	5,600	5,500		7,300	6,900	6,600	6,500
135					5,400	5,300			7,000	6,600	6,400	6,300
140									6,600	6,300	6,100	6,100
145									6,300	6,100	5,900	5,900
150									6,000	5,800	5,700	
155									5,800	5,600	5,500	
160									5,500	5,400	5,400	
165									5,300	5,200		
Min Angle	0.0	0.0	0.0	0.0	14.5	18.5	28.5	9.5	15.0	18.0	26.0	18.5
Max Rad.	127.9	127.5	124.9	120.1	140.0	140.0	135.0	126.6	170.0	170.0	165.0	156.8
Capacity	3,100	3,100	3,400	3,900	0	0	0	0	0	0	0	0

1071110



PORTLAND OFFICE: 503.283.3111
 SEATTLE OFFICE: 206.784.1054
WWW.NESSCAMPBELL.COM

Rated Lifting Capacities in Pounds

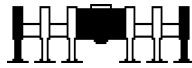

Full

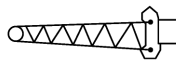

92ft Offset Fly



102,000 lbs



Radius (ft)	Boom Length (ft)											
	Fly Offset											
	120.3				152.4				169.0			
	2°	15°	30°	45°	2°	15°	30°	45°	2°	15°	30°	45°
35	16,500											
40	16,500				13,500							
45	16,500				13,500							
50	16,500	14,500			13,500				12,500			
55	15,900	13,900			13,500				12,500			
60	15,200	13,300			13,500	13,400			12,500			
65	14,500	12,700	11,300		13,500	13,400			12,500	12,400		
70	13,800	12,200	10,900		13,500	13,000			12,500	12,400		
75	13,200	11,800	10,500	9,700	13,500	12,600	11,100		12,500	12,400		
80	12,700	11,300	10,200	9,400	13,500	12,200	10,700		12,500	12,400	10,900	
85	12,200	10,900	9,900	9,200	13,400	11,800	10,400	9,500	12,500	12,100	10,700	
90	11,700	10,500	9,600	8,900	12,900	11,400	10,100	9,300	12,500	11,800	10,400	
95	11,200	10,200	9,300	8,700	12,500	11,000	9,800	9,100	12,500	11,400	10,100	9,200
100	10,800	9,800	9,000	8,400	12,000	10,700	9,600	8,800	12,500	11,100	9,800	9,000
105	10,400	9,500	8,700	8,200	11,600	10,300	9,300	8,600	12,200	10,700	9,600	8,800
110	10,100	9,200	8,500	8,000	11,200	10,000	9,100	8,400	11,800	10,400	9,300	8,600
115	9,700	8,900	8,300	7,800	10,900	9,800	8,800	8,300	11,400	10,100	9,100	8,500
120	9,400	8,600	8,000	7,600	10,500	9,500	8,600	8,100	11,100	9,900	8,900	8,300
125	9,100	8,400	7,700	7,400	10,200	9,200	8,400	7,900	10,700	9,600	8,700	8,100
130	8,800	8,100	7,500	7,200	9,900	9,000	8,200	7,700	10,400	9,300	8,500	7,900
135	8,400	7,800	7,300	7,000	9,600	8,700	8,000	7,500	10,100	9,100	8,300	7,800
140	8,100	7,500	7,100	6,800	9,300	8,500	7,800	7,400	9,800	8,900	8,100	7,600
145	7,800	7,300	6,800	6,600	9,000	8,200	7,600	7,200	9,500	8,700	7,900	7,400
150	7,500	7,000	6,600	6,500	8,800	8,000	7,400	7,000	9,300	8,400	7,700	7,300
155	7,200	6,700	6,400	6,300	8,500	7,800	7,200	6,900	9,000	8,200	7,500	7,100
160	6,900	6,500	6,200	6,100	8,200	7,500	7,000	6,700	8,800	8,000	7,300	7,000
165	6,600	6,300	6,000	6,000	7,700	7,300	6,800	6,600	8,500	7,800	7,200	6,800
170	6,400	6,100	5,900	5,800	7,200	7,100	6,600	6,400	8,100	7,500	7,000	6,700
175	6,100	5,900	5,700		6,800	6,900	6,500	6,300	7,700	7,300	6,800	6,600
180	5,900	5,700	5,500		6,400	6,600	6,300	6,200	7,300	7,100	6,600	6,400
185	5,700	5,500	5,400		6,000	6,300	6,100	6,000	6,900	6,900	6,500	6,300
190	5,500	5,300	5,300		5,700	5,900	6,000	5,900	6,500	6,700	6,300	6,200
195	5,300	5,200			5,300	5,500	5,700	5,800	6,100	6,300	6,200	6,100
200					5,000	5,200	5,400	5,400	5,800	6,000	6,000	5,900
205					4,700	4,900	5,000		5,500	5,600	5,800	5,800
210					4,400	4,600	4,700		5,200	5,300	5,500	5,500
215					4,100	4,300	4,300		4,700	5,000	5,100	5,200
220					3,900	4,000	4,000		4,300	4,600	4,800	
225					3,600	3,700			3,900	4,200	4,400	
230					3,400	3,400			3,500	3,800	3,900	
235									3,100	3,400	3,500	
240									2,800	3,000	3,000	
245									2,500	2,600		
Min Angle	18.0	20.0	26.5	17.0	12.5	13.5	15.5	28.5	15.5	17.0	22.0	23.0
Max Rad.	200.0	200.0	195.0	188.0	235.0	233.9	229.1	220.0	250.0	250.0	245.0	236.6
Capacity	0	0	0	0	0	0	0	0	0	0	0	0

1071110



PORTLAND OFFICE: 503.283.3111
SEATTLE OFFICE: 206.784.1054
WWW.NESSCAMPBELL.COM

Rated Lifting Capacities in Pounds

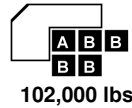
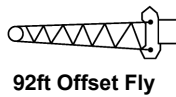
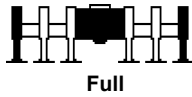

Radius (ft)	Boom Length (ft)			
	Fly Offset			
	185.5			
	2°	15°	30°	45°
50	10,700			
55	10,700			
60	10,700			
65	10,700			
70	10,700	10,600		
75	10,700	10,600		
80	10,700	10,600		
85	10,700	10,600	10,400	
90	10,700	10,600	10,400	
95	10,700	10,600	10,300	
100	10,700	10,600	10,100	9,200
105	10,700	10,600	9,800	9,000
110	10,700	10,600	9,600	8,800
115	10,700	10,500	9,400	8,600
120	10,700	10,200	9,100	8,400
125	10,700	10,000	8,900	8,300
130	10,700	9,700	8,700	8,100
135	10,600	9,500	8,500	8,000
140	10,300	9,200	8,400	7,800
145	10,000	9,000	8,200	7,600
150	9,800	8,800	8,000	7,500
155	9,500	8,600	7,800	7,300
160	9,300	8,400	7,600	7,200
165	9,000	8,200	7,500	7,100
170	8,800	8,000	7,300	6,900
175	8,200	7,700	7,100	6,800
180	7,600	7,600	7,000	6,700
185	6,900	7,400	6,800	6,500
190	6,300	7,000	6,600	6,400
195	5,800	6,400	6,500	6,300
200	5,200	5,800	6,300	6,200
205	4,700	5,300	5,700	6,000
210	4,200	4,800	5,200	5,400
215	3,800	4,300	4,700	4,800
220	3,400	3,800	4,200	4,300
225	2,900	3,400	3,700	3,800
230	2,600	2,900	3,200	3,200
235	2,200	2,500	2,800	
240		2,100	2,300	
Min Angle	35.5	36.5	36.0	35.5
Max Rad.	237.5	241.7	243.8	243.0
Capacity	0	0	0	0

1071110



PORTLAND OFFICE: 503.283.3111
 SEATTLE OFFICE: 206.784.1054
WWW.NESSCAMPBELL.COM

Rated Lifting Capacities in Pounds

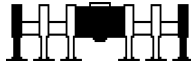

Full

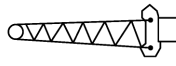

92ft Offset Fly



102,000 lbs



Radius (ft)	Boom Length (ft)											
	Fly Offset											
	44.3				73.5				103.8			
	2°	15°	30°	45°	2°	15°	30°	45°	2°	15°	30°	45°
20	19,800											
25	18,100				17,300							
30	16,700				17,300				15,200			
35	15,500	14,400			17,300				15,200			
40	14,400	13,400			16,300	14,600			15,200			
45	13,400	12,600	11,900		15,300	13,800			15,200	14,700		
50	12,600	11,800	11,200		14,400	13,100			15,200	14,000		
55	11,800	11,200	10,600		13,600	12,400	11,400		15,200	13,400		
60	11,100	10,500	10,000	9,700	12,900	11,800	10,900		14,400	12,800	11,500	
65	10,500	10,000	9,500	9,300	12,200	11,200	10,400	9,800	13,700	12,200	11,000	
70	9,900	9,500	9,100	8,800	11,600	10,700	10,000	9,400	13,100	11,700	10,600	9,800
75	9,400	9,000	8,700	8,400	11,000	10,200	9,500	9,100	12,500	11,300	10,200	9,500
80	8,900	8,600	8,300	8,100	10,500	9,800	9,200	8,700	12,000	10,800	9,900	9,200
85	8,400	8,100	7,800	7,700	10,000	9,400	8,800	8,400	11,500	10,400	9,500	8,900
90	7,900	7,700	7,400	7,300	9,600	9,000	8,500	8,200	11,000	10,000	9,200	8,700
95	7,400	7,200	7,100	7,000	9,200	8,700	8,200	7,900	10,600	9,700	8,900	8,400
100	7,000	6,800	6,700	6,600	8,800	8,300	7,800	7,600	10,200	9,300	8,600	8,200
105	6,500	6,400	6,300	6,300	8,400	7,900	7,500	7,300	9,800	9,000	8,400	8,000
110	6,100	6,000	6,000	6,000	8,000	7,600	7,200	7,000	9,400	8,700	8,100	7,700
115	5,800	5,700	5,700		7,600	7,200	6,900	6,800	9,100	8,400	7,800	7,500
120	5,400	5,400	5,400		7,200	6,900	6,600	6,500	8,800	8,100	7,600	7,300
125	5,100	5,100			6,800	6,500	6,300	6,300	8,400	7,800	7,300	7,100
130					6,500	6,200	6,100	6,100	8,100	7,500	7,100	6,900
135					6,100	6,000	5,800	5,900	7,700	7,200	6,800	6,700
140					5,800	5,700	5,600		7,400	6,900	6,600	6,400
145					5,600	5,500	5,400		7,000	6,700	6,400	6,300
150					5,300	5,200			6,700	6,400	6,200	6,100
155									6,400	6,200	6,000	5,900
160									6,200	5,900	5,800	5,800
165									5,900	5,700	5,600	
170									5,700	5,500	5,400	
175									5,500	5,300	5,300	
180									5,300	5,200		
Min Angle	0.0	0.0	0.0	0.0	14.0	17.0	26.5	26.0	15.5	17.5	25.0	22.5
Max Rad.	127.9	127.5	124.9	120.1	155.0	155.0	150.0	141.2	185.0	185.0	180.0	171.4
Capacity	3,100	3,100	3,400	3,900	0	0	0	0	0	0	0	0

1071120



PORTLAND OFFICE: 503.283.3111
 SEATTLE OFFICE: 206.784.1054
WWW.NESSCAMPBELL.COM

Rated Lifting Capacities in Pounds

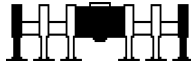

Full

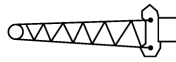

92ft Offset Fly



102,000 lbs



Radius (ft)	Boom Length (ft)											
	Fly Offset											
	119.4				135.4				152.0			
	2°	15°	30°	45°	2°	15°	30°	45°	2°	15°	30°	45°
35	14,900				14,900							
40	14,900				14,900				14,100			
45	14,900				14,900				14,100			
50	14,900	14,500			14,900				14,100			
55	14,900	13,800			14,900	14,200			14,100			
60	14,900	13,300			14,900	13,700			14,100	14,000		
65	14,400	12,700	11,300		14,900	13,100			14,100	13,500		
70	13,800	12,200	10,900		14,500	12,600	11,200		14,100	13,000	11,400	
75	13,200	11,700	10,500	9,700	13,900	12,200	10,800		14,100	12,600	11,100	
80	12,600	11,300	10,200	9,400	13,300	11,700	10,500	9,600	13,900	12,100	10,700	
85	12,100	10,900	9,900	9,200	12,800	11,300	10,100	9,300	13,400	11,700	10,400	9,500
90	11,700	10,500	9,500	8,900	12,300	10,900	9,800	9,100	12,900	11,400	10,100	9,300
95	11,200	10,100	9,300	8,700	11,800	10,600	9,500	8,900	12,500	11,000	9,800	9,100
100	10,800	9,800	9,000	8,400	11,400	10,200	9,300	8,600	12,000	10,700	9,600	8,800
105	10,400	9,500	8,700	8,200	11,000	9,900	9,000	8,400	11,600	10,300	9,300	8,600
110	10,000	9,200	8,500	8,000	10,600	9,600	8,800	8,200	11,200	10,000	9,100	8,400
115	9,700	8,900	8,200	7,800	10,300	9,300	8,500	8,000	10,900	9,700	8,800	8,300
120	9,400	8,600	8,000	7,600	9,900	9,100	8,300	7,800	10,500	9,500	8,600	8,100
125	9,000	8,300	7,700	7,400	9,600	8,800	8,100	7,600	10,200	9,200	8,400	7,900
130	8,700	8,000	7,500	7,200	9,300	8,500	7,900	7,400	9,900	9,000	8,200	7,700
135	8,400	7,800	7,300	7,000	9,000	8,300	7,600	7,300	9,600	8,700	8,000	7,500
140	8,100	7,500	7,100	6,800	8,700	8,000	7,400	7,100	9,300	8,500	7,800	7,300
145	7,800	7,200	6,800	6,600	8,400	7,800	7,200	6,900	9,000	8,200	7,600	7,200
150	7,500	7,000	6,600	6,400	8,100	7,500	7,000	6,800	8,800	8,000	7,400	7,000
155	7,200	6,700	6,400	6,300	7,900	7,300	6,800	6,600	8,500	7,700	7,200	6,900
160	6,900	6,500	6,200	6,100	7,600	7,000	6,600	6,400	8,200	7,500	7,000	6,700
165	6,600	6,200	6,000	6,000	7,300	6,800	6,400	6,300	7,900	7,300	6,800	6,600
170	6,300	6,000	5,800	5,800	7,000	6,500	6,200	6,100	7,700	7,100	6,600	6,400
175	6,100	5,800	5,700		6,700	6,300	6,100	6,000	7,400	6,800	6,400	6,300
180	5,900	5,600	5,500		6,500	6,100	5,900	5,900	7,100	6,600	6,300	6,100
185	5,600	5,500	5,400		6,200	5,900	5,700	5,800	6,900	6,400	6,100	6,000
190	5,400	5,300	5,300		6,000	5,800	5,600		6,600	6,200	6,000	5,900
195	5,300	5,200			5,800	5,600	5,500		6,400	6,000	5,800	5,800
200					5,600	5,400	5,400		6,200	5,900	5,700	5,700
205					5,400	5,300	5,300		6,000	5,700	5,600	
210					5,300	5,200			5,800	5,600	5,400	
215									5,600	5,400	5,300	
220									5,400	5,300	5,300	
225									5,000	5,200		
230									4,700			
Min Angle	16.5	19.0	25.5	19.5	18.0	20.5	26.0	16.5	13.0	22.0	12.5	13.5
Max Rad. Capacity	200.0	200.0	195.0	187.0	215.0	215.0	210.0	203.1	233.1	230.0	228.6	219.6
	0	0	0	0	0	0	0	0	0	0	0	0

1071120



PORTLAND OFFICE: 503.283.3111
 SEATTLE OFFICE: 206.784.1054
 WWW.NESSCAMPBELL.COM

Rated Lifting Capacities in Pounds

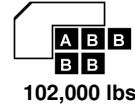
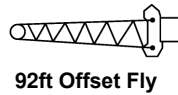
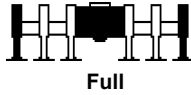

Radius (ft)	Boom Length (ft)			
	Fly Offset			
	168.5			
	2°	15°	30°	45°
45	12,200			
50	12,200			
55	12,200			
60	12,200	12,100		
65	12,200	12,100		
70	12,200	12,100		
75	12,200	12,100		
80	12,200	12,100	10,900	
85	12,200	12,100	10,600	
90	12,200	11,700	10,400	9,400
95	12,200	11,400	10,100	9,200
100	12,200	11,100	9,800	9,000
105	12,200	10,700	9,600	8,800
110	11,800	10,400	9,300	8,600
115	11,400	10,100	9,100	8,400
120	11,100	9,800	8,900	8,300
125	10,700	9,600	8,700	8,100
130	10,400	9,300	8,500	7,900
135	10,100	9,100	8,300	7,800
140	9,800	8,900	8,100	7,600
145	9,500	8,600	7,900	7,400
150	9,300	8,400	7,700	7,300
155	9,000	8,200	7,500	7,100
160	8,800	8,000	7,300	7,000
165	8,500	7,700	7,200	6,800
170	8,200	7,500	7,000	6,700
175	8,000	7,300	6,800	6,500
180	7,700	7,100	6,600	6,400
185	7,500	6,900	6,500	6,300
190	7,200	6,700	6,300	6,200
195	6,700	6,500	6,200	6,000
200	6,200	6,300	6,000	5,900
205	5,700	6,100	5,900	5,800
210	5,200	5,600	5,700	5,700
215	4,800	5,200	5,400	5,500
220	4,300	4,700	4,900	
225	3,900	4,300	4,400	
230	3,600	3,800	4,000	
235	3,200	3,400	3,500	
240	2,800	3,000		
245	2,500	2,700		
Min Angle	14.5	15.5	21.0	23.0
Max Rad.	250.0	250.0	245.0	236.2
Capacity	0	0	0	0

1071120



PORTLAND OFFICE: 503.283.3111
 SEATTLE OFFICE: 206.784.1054
WWW.NESSCAMPBELL.COM

Rated Lifting Capacities in Pounds

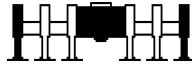

Full

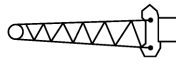

92ft Hydraulic Offset Fly



102,000 lbs



Radius (ft)	Boom Length (ft)											
	Fly Offset											
	44.3			73.5			103.8			134.9		
	2°-15°	15°-30°	30°-45°	2°-15°	15°-30°	30°-45°	2°-15°	15°-30°	30°-45°	2°-15°	15°-30°	30°-45°
20	19,800											
25	18,100			17,300								
30	15,500	15,500		17,300			15,200					
35	14,400	14,400		15,500	15,500		15,200			12,900		
40	13,400	13,400		14,600	14,600		15,200			12,900		
45	12,600	11,900	11,900	13,800	13,800		14,700	14,700		12,900		
50	11,800	11,200	11,200	13,100	11,900	11,900	14,000	14,000		12,800	12,800	
55	11,200	10,600	10,200	12,400	11,400	11,400	13,400	13,400		12,800	12,800	
60	10,500	10,000	9,700	11,800	10,900	10,200	12,800	11,500	11,500	12,800	12,800	
65	10,000	9,500	9,300	11,200	10,400	9,800	12,200	11,000	11,000	12,800	12,800	
70	9,500	9,100	8,800	10,700	10,000	9,400	11,700	10,600	9,800	12,600	11,200	11,200
75	9,000	8,700	8,400	10,200	9,500	9,100	11,300	10,200	9,500	12,200	10,800	10,800
80	8,600	8,300	8,100	9,800	9,200	8,700	10,800	9,900	9,200	11,700	10,500	9,600
85	8,100	7,800	7,700	9,400	8,800	8,400	10,400	9,500	8,900	11,300	10,100	9,300
90	7,700	7,400	7,300	9,000	8,500	8,200	10,000	9,200	8,700	10,900	9,800	9,100
95	7,200	7,100	7,000	8,700	8,200	7,900	9,700	8,900	8,400	10,600	9,500	8,900
100	6,800	6,700	6,600	8,300	7,800	7,600	9,300	8,600	8,200	10,200	9,300	8,600
105	6,400	6,300	6,300	7,900	7,500	7,300	9,000	8,400	8,000	9,900	9,000	8,400
110	6,000	6,000	6,000	7,600	7,200	7,000	8,700	8,100	7,700	9,600	8,800	8,200
115	5,700	5,700	5,700	7,200	6,900	6,800	8,400	7,800	7,500	9,300	8,500	8,000
120	5,400	5,400	5,400	6,900	6,600	6,500	8,100	7,600	7,300	9,000	8,300	7,800
125	5,100	5,100		6,500	6,300	6,300	7,800	7,300	7,100	8,800	8,100	7,600
130				6,200	6,100	6,100	7,500	7,100	6,900	8,500	7,900	7,400
135				6,000	5,800	5,800	7,200	6,800	6,700	8,300	7,600	7,300
140				5,700	5,600	5,600	6,900	6,600	6,400	8,000	7,400	7,100
145				5,500	5,400		6,700	6,400	6,300	7,700	7,200	6,900
150				5,200			6,400	6,200	6,100	7,500	7,000	6,700
155							6,200	6,000	5,900	7,200	6,800	6,600
160							5,900	5,800	5,800	7,000	6,600	6,400
165							5,700	5,600	5,600	6,800	6,400	6,300
170							5,500	5,400	5,400	6,500	6,200	6,100
175							5,300	5,300		6,300	6,000	6,000
180							5,200			6,100	5,900	5,900
185										5,900	5,700	5,700
190										5,500	5,600	5,600
195										5,200	5,400	5,400
200										5,000	5,100	5,100
205										4,700	4,800	
210										4,500		
Min Angle	0.0	0.0	0.0	14.0	26.5	26.0	15.5	25.0	22.5	18.0	26.0	19.5
Max Rad.	127.9	127.5	124.9	155.0	150.0	141.2	185.0	180.0	171.4	215.0	210.0	202.6
Capacity	3,100	3,100	3,400	0	0	0	0	0	0	0	0	0

1072100



PORTLAND OFFICE: 503.283.3111
SEATTLE OFFICE: 206.784.1054

WWW.NESSCAMPBELL.COM

Rated Lifting Capacities in Pounds

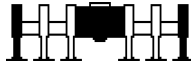

Full

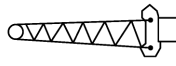

92ft Hydraulic Offset Fly



102,000 lbs



Radius (ft)	Boom Length (ft)								
	Fly Offset								
	167.1			183.6			200.1		
	2°-15°	15°-30°	30°-45°	2°-15°	15°-30°	30°-45°	2°-15°	15°-30°	30°-45°
45	10,400								
50	10,400			9,600					
55	10,300	10,300		9,600			8,200		
60	10,300	10,300		9,500	9,500		8,200		
65	10,300	10,300		9,500	9,500		8,100	8,100	
70	10,300	10,300		9,500	9,500		8,100	8,100	
75	10,300	10,200	10,200	9,500	9,500		8,100	8,100	
80	10,300	10,200	10,200	9,500	9,400	9,400	8,100	8,100	
85	10,300	10,200	9,600	9,500	9,400	9,400	8,100	8,000	8,000
90	10,300	10,200	9,400	9,500	9,400	9,200	8,100	8,000	8,000
95	10,300	10,100	9,200	9,500	9,400	9,200	8,100	8,000	7,800
100	10,300	9,800	9,000	9,500	9,400	9,100	8,100	8,000	7,800
105	10,300	9,500	8,800	9,500	9,400	9,000	8,100	8,000	7,800
110	10,300	9,300	8,600	9,500	9,400	8,800	8,100	8,000	7,800
115	10,100	9,100	8,400	9,500	9,300	8,600	8,100	8,000	7,800
120	9,800	8,900	8,300	9,500	9,100	8,400	8,100	8,000	7,800
125	9,600	8,700	8,100	9,500	8,900	8,300	8,100	8,000	7,800
130	9,300	8,500	7,900	9,500	8,700	8,100	8,100	8,000	7,800
135	9,100	8,300	7,700	9,400	8,500	8,000	8,100	8,000	7,800
140	8,800	8,100	7,600	9,200	8,300	7,800	8,100	8,000	7,800
145	8,600	7,900	7,400	9,000	8,200	7,600	8,100	8,000	7,800
150	8,400	7,700	7,200	8,800	8,000	7,500	8,100	8,000	7,700
155	8,200	7,500	7,100	8,600	7,800	7,300	8,100	8,000	7,500
160	7,800	7,300	7,000	8,300	7,600	7,200	8,100	7,900	7,400
165	7,300	7,100	6,800	8,100	7,400	7,000	8,100	7,700	7,200
170	6,900	7,000	6,700	7,700	7,300	6,900	8,100	7,500	7,100
175	6,500	6,800	6,500	7,300	7,100	6,800	8,000	7,400	7,000
180	6,100	6,400	6,400	6,900	6,900	6,600	7,600	7,200	6,900
185	5,700	6,000	6,200	6,500	6,700	6,500	7,100	7,100	6,700
190	5,300	5,600	5,800	6,100	6,300	6,400	6,500	6,900	6,600
195	5,000	5,200	5,400	5,800	6,000	6,200	6,000	6,600	6,500
200	4,700	4,900	5,100	5,400	5,600	5,800	5,400	6,000	6,400
205	4,400	4,600	4,800	5,100	5,300	5,500	4,900	5,500	6,000
210	4,100	4,300	4,400	4,800	5,000	5,200	4,400	5,000	5,500
215	3,800	4,000	4,100	4,500	4,700	4,900	4,000	4,500	4,900
220	3,500	3,700	3,800	4,200	4,400	4,500	3,500	4,000	4,400
225	3,300	3,400	3,500	4,000	4,100	4,300	3,100	3,600	4,000
230	3,000	3,200	3,200	3,600	3,900	4,000	2,700	3,200	3,500
235	2,800	2,900		3,300	3,600	3,700	2,400	2,800	3,100
240	2,600	2,700		2,900	3,200	3,300		2,400	2,600
245				2,600	2,800	2,800			2,200
250				2,300	2,500	2,300			
255					2,100				
Min Angle	22.0	19.0	21.5	25.5	26.5	25.5	41.0	41.5	41.0
Max Rad. Capacity	245.0	243.7	234.7	255.0	256.7	251.3	240.0	245.0	248.0
	0	0	0	0	0	0	0	0	0

1072100



PORTLAND OFFICE: 503.283.3111
 SEATTLE OFFICE: 206.784.1054
WWW.NESSCAMPBELL.COM

Rated Lifting Capacities in Pounds

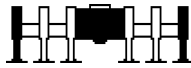

Full

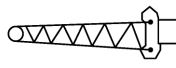

92ft Hydraulic Offset Fly



102,000 lbs



Radius (ft)	Boom Length (ft)											
	Fly Offset											
	44.3			58.9			89.1			120.3		
	2°-15°	15°-30°	30°-45°	2°-15°	15°-30°	30°-45°	2°-15°	15°-30°	30°-45°	2°-15°	15°-30°	30°-45°
20	19,800			19,700								
25	18,100			19,200			18,900					
30	15,500	15,500		16,000	16,000		18,900					
35	14,400	14,400		15,000	15,000		18,300			16,500		
40	13,400	13,400		14,100	14,100		15,100	15,100		16,500		
45	12,600	11,900	11,900	13,300	12,200	12,200	14,300	14,300		16,500		
50	11,800	11,200	11,200	12,500	11,600	11,600	13,600	13,600		14,500	14,500	
55	11,200	10,600	10,200	11,800	11,000	11,000	12,900	11,700	11,700	13,900	13,900	
60	10,500	10,000	9,700	11,200	10,500	10,000	12,300	11,200	11,200	13,300	11,700	11,700
65	10,000	9,500	9,300	10,600	10,000	9,600	11,800	10,700	10,000	12,700	11,300	11,300
70	9,500	9,100	8,800	10,100	9,600	9,200	11,300	10,300	9,700	12,200	10,900	10,000
75	9,000	8,700	8,400	9,600	9,100	8,800	10,800	9,900	9,300	11,800	10,500	9,700
80	8,600	8,300	8,100	9,200	8,700	8,400	10,400	9,600	9,000	11,300	10,200	9,400
85	8,100	7,800	7,700	8,800	8,400	8,100	9,900	9,200	8,700	10,900	9,900	9,200
90	7,700	7,400	7,300	8,400	8,000	7,800	9,600	8,900	8,400	10,500	9,600	8,900
95	7,200	7,100	7,000	8,000	7,700	7,500	9,200	8,600	8,200	10,200	9,300	8,700
100	6,800	6,700	6,600	7,600	7,300	7,200	8,900	8,300	7,900	9,800	9,000	8,400
105	6,400	6,300	6,300	7,200	7,000	6,900	8,500	8,000	7,700	9,500	8,700	8,200
110	6,000	6,000	6,000	6,800	6,600	6,600	8,200	7,700	7,400	9,200	8,500	8,000
115	5,700	5,700	5,700	6,500	6,300	6,300	7,900	7,400	7,200	8,900	8,300	7,800
120	5,400	5,400	5,400	6,200	6,000	6,000	7,600	7,200	7,000	8,600	8,000	7,600
125	5,100	5,100		5,800	5,800	5,800	7,200	6,900	6,700	8,400	7,700	7,400
130				5,600	5,500		6,900	6,600	6,500	8,100	7,500	7,200
135				5,300			6,600	6,400	6,300	7,800	7,300	7,000
140							6,300	6,100	6,100	7,500	7,100	6,800
145							6,100	5,900	5,900	7,300	6,800	6,600
150							5,800	5,700	5,700	7,000	6,600	6,500
155							5,600	5,500	5,500	6,700	6,400	6,300
160							5,400	5,400		6,500	6,200	6,100
165							5,200			6,300	6,000	6,000
170										6,100	5,900	5,800
175										5,900	5,700	5,700
180										5,700	5,500	5,500
185										5,500	5,400	5,400
190										5,300	5,300	
195										5,200		
Min Angle	0.0	0.0	0.0	14.5	28.5	9.5	15.0	26.0	18.5	18.0	26.5	17.0
Max Rad. Capacity	127.9	127.5	124.9	140.0	135.0	126.6	170.0	165.0	156.8	200.0	195.0	188.0
	3,100	3,100	3,400	0	0	0	0	0	0	0	0	0

1072110



PORTLAND OFFICE: 503.283.3111
 SEATTLE OFFICE: 206.784.1054
WWW.NESSCAMPBELL.COM

Rated Lifting Capacities in Pounds

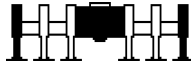

Full

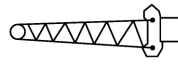

92ft Hydraulic Offset Fly



102,000 lbs



Radius (ft)	Boom Length (ft)								
	Fly Offset								
	152.4			169.0			185.5		
	2°-15°	15°-30°	30°-45°	2°-15°	15°-30°	30°-45°	2°-15°	15°-30°	30°-45°
40	13,500								
45	13,500								
50	13,500			12,500			10,700		
55	13,300	13,300		12,500			10,700		
60	13,300	13,300		12,400	12,400		10,700		
65	13,300	13,300		12,400	12,400		10,600	10,600	
70	13,000	11,400	11,400	12,400	12,400		10,600	10,600	
75	12,600	11,100	11,100	12,400	11,300	11,300	10,600	10,600	
80	12,200	10,700	9,800	12,400	10,900	10,900	10,600	10,400	10,400
85	11,800	10,400	9,500	12,100	10,700	10,700	10,600	10,400	10,400
90	11,400	10,100	9,300	11,800	10,400	9,400	10,600	10,400	10,400
95	11,000	9,800	9,100	11,400	10,100	9,200	10,600	10,300	9,400
100	10,700	9,600	8,800	11,100	9,800	9,000	10,600	10,100	9,200
105	10,300	9,300	8,600	10,700	9,600	8,800	10,600	9,800	9,000
110	10,000	9,100	8,400	10,400	9,300	8,600	10,600	9,600	8,800
115	9,800	8,800	8,300	10,100	9,100	8,500	10,500	9,400	8,600
120	9,500	8,600	8,100	9,900	8,900	8,300	10,200	9,100	8,400
125	9,200	8,400	7,900	9,600	8,700	8,100	10,000	8,900	8,300
130	9,000	8,200	7,700	9,300	8,500	7,900	9,700	8,700	8,100
135	8,700	8,000	7,500	9,100	8,300	7,800	9,500	8,500	8,000
140	8,500	7,800	7,400	8,900	8,100	7,600	9,200	8,400	7,800
145	8,200	7,600	7,200	8,700	7,900	7,400	9,000	8,200	7,600
150	8,000	7,400	7,000	8,400	7,700	7,300	8,800	8,000	7,500
155	7,800	7,200	6,900	8,200	7,500	7,100	8,600	7,800	7,300
160	7,500	7,000	6,700	8,000	7,300	7,000	8,400	7,600	7,200
165	7,300	6,800	6,600	7,800	7,200	6,800	8,200	7,500	7,100
170	7,100	6,600	6,400	7,500	7,000	6,700	8,000	7,300	6,900
175	6,800	6,500	6,300	7,300	6,800	6,600	7,700	7,100	6,800
180	6,400	6,300	6,200	7,100	6,600	6,400	7,600	7,000	6,700
185	6,000	6,100	6,000	6,900	6,500	6,300	6,900	6,800	6,500
190	5,700	5,900	5,900	6,500	6,300	6,200	6,300	6,600	6,400
195	5,300	5,500	5,700	6,100	6,200	6,100	5,800	6,400	6,300
200	5,000	5,200	5,400	5,800	6,000	5,900	5,200	5,800	6,200
205	4,700	4,900	5,000	5,500	5,600	5,800	4,700	5,300	5,700
210	4,400	4,600	4,700	5,200	5,300	5,500	4,200	4,800	5,200
215	4,100	4,300	4,300	4,700	5,000	5,100	3,800	4,300	4,700
220	3,900	4,000		4,300	4,600	4,800	3,400	3,800	4,200
225	3,600	3,700		3,900	4,200	4,300	2,900	3,400	3,700
230	3,400			3,500	3,800	3,800	2,600	2,900	3,200
235				3,100	3,400	3,300	2,200	2,500	2,700
240				2,800	3,000			2,100	2,300
245				2,500					

Min Angle	13.5	15.5	28.5	15.5	22.0	23.0	35.5	36.5	35.5
Max Rad. Capacity	233.9	229.1	220.0	250.0	245.0	236.6	237.5	241.7	243.0
	0	0	0	0	0	0	0	0	0

1072110



PORTLAND OFFICE: 503.283.3111
 SEATTLE OFFICE: 206.784.1054
WWW.NESSCAMPBELL.COM

Rated Lifting Capacities in Pounds

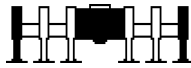

Full

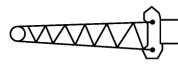

92ft Hydraulic Offset Fly



102,000 lbs



Radius (ft)	Boom Length (ft)											
	Fly Offset											
	44.3			73.5			103.8			119.4		
	2°-15°	15°-30°	30°-45°	2°-15°	15°-30°	30°-45°	2°-15°	15°-30°	30°-45°	2°-15°	15°-30°	30°-45°
20	19,800											
25	18,100			17,300								
30	15,500	15,500		17,300			15,200					
35	14,400	14,400		15,500	15,500		15,200			14,900		
40	13,400	13,400		14,600	14,600		15,200			14,900		
45	12,600	11,900	11,900	13,800	13,800		14,700	14,700		14,900		
50	11,800	11,200	11,200	13,100	11,900	11,900	14,000	14,000		14,500	14,500	
55	11,200	10,600	10,200	12,400	11,400	11,400	13,400	13,400		13,800	13,800	
60	10,500	10,000	9,700	11,800	10,900	10,200	12,800	11,500	11,500	13,300	13,300	
65	10,000	9,500	9,300	11,200	10,400	9,800	12,200	11,000	11,000	12,700	11,300	11,300
70	9,500	9,100	8,800	10,700	10,000	9,400	11,700	10,600	9,800	12,200	10,900	10,900
75	9,000	8,700	8,400	10,200	9,500	9,100	11,300	10,200	9,500	11,700	10,500	9,700
80	8,600	8,300	8,100	9,800	9,200	8,700	10,800	9,900	9,200	11,300	10,200	9,400
85	8,100	7,800	7,700	9,400	8,800	8,400	10,400	9,500	8,900	10,900	9,900	9,200
90	7,700	7,400	7,300	9,000	8,500	8,200	10,000	9,200	8,700	10,500	9,500	8,900
95	7,200	7,100	7,000	8,700	8,200	7,900	9,700	8,900	8,400	10,100	9,300	8,700
100	6,800	6,700	6,600	8,300	7,800	7,600	9,300	8,600	8,200	9,800	9,000	8,400
105	6,400	6,300	6,300	7,900	7,500	7,300	9,000	8,400	8,000	9,500	8,700	8,200
110	6,000	6,000	6,000	7,600	7,200	7,000	8,700	8,100	7,700	9,200	8,500	8,000
115	5,700	5,700	5,700	7,200	6,900	6,800	8,400	7,800	7,500	8,900	8,200	7,800
120	5,400	5,400	5,400	6,900	6,600	6,500	8,100	7,600	7,300	8,600	8,000	7,600
125	5,100	5,100		6,500	6,300	6,300	7,800	7,300	7,100	8,300	7,700	7,400
130				6,200	6,100	6,100	7,500	7,100	6,900	8,000	7,500	7,200
135				6,000	5,800	5,800	7,200	6,800	6,700	7,800	7,300	7,000
140				5,700	5,600	5,600	6,900	6,600	6,400	7,500	7,100	6,800
145				5,500	5,400		6,700	6,400	6,300	7,200	6,800	6,600
150				5,200			6,400	6,200	6,100	7,000	6,600	6,400
155							6,200	6,000	5,900	6,700	6,400	6,300
160							5,900	5,800	5,800	6,500	6,200	6,100
165							5,700	5,600	5,600	6,200	6,000	6,000
170							5,500	5,400	5,400	6,000	5,800	5,800
175							5,300	5,300		5,800	5,700	5,700
180							5,200			5,600	5,500	5,500
185										5,500	5,400	5,400
190										5,300	5,300	
195										5,200		
Min Angle	0.0	0.0	0.0	14.0	26.5	26.0	15.5	25.0	22.5	16.5	25.5	19.5
Max Rad. Capacity	127.9	127.5	124.9	155.0	150.0	141.2	185.0	180.0	171.4	200.0	195.0	187.0
	3,100	3,100	3,400	0	0	0	0	0	0	0	0	0

1072120



PORTLAND OFFICE: 503.283.3111
 SEATTLE OFFICE: 206.784.1054
WWW.NESSCAMPBELL.COM

Rated Lifting Capacities in Pounds

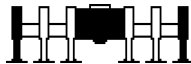

Full

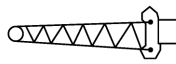

92ft Hydraulic Offset Fly

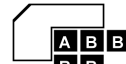

102,000 lbs



360°



Radius (ft)	Boom Length (ft)								
	Fly Offset								
	135.4			152.0			168.5		
	2°-15°	15°-30°	30°-45°	2°-15°	15°-30°	30°-45°	2°-15°	15°-30°	30°-45°
35	14,900								
40	14,900			14,100					
45	14,900			14,100			12,200		
50	14,900			14,100			12,200		
55	14,200	14,200		14,000	14,000		12,200		
60	13,700	13,700		14,000	14,000		12,100	12,100	
65	13,100	11,500	11,500	13,500	13,500		12,100	12,100	
70	12,600	11,200	11,200	13,000	11,400	11,400	12,100	12,100	
75	12,200	10,800	9,900	12,600	11,100	11,100	12,100	11,300	11,300
80	11,700	10,500	9,600	12,100	10,700	9,800	12,100	10,900	10,900
85	11,300	10,100	9,300	11,700	10,400	9,500	12,100	10,600	9,700
90	10,900	9,800	9,100	11,400	10,100	9,300	11,700	10,400	9,400
95	10,600	9,500	8,900	11,000	9,800	9,100	11,400	10,100	9,200
100	10,200	9,300	8,600	10,700	9,600	8,800	11,100	9,800	9,000
105	9,900	9,000	8,400	10,300	9,300	8,600	10,700	9,600	8,800
110	9,600	8,800	8,200	10,000	9,100	8,400	10,400	9,300	8,600
115	9,300	8,500	8,000	9,700	8,800	8,300	10,100	9,100	8,400
120	9,100	8,300	7,800	9,500	8,600	8,100	9,800	8,900	8,300
125	8,800	8,100	7,600	9,200	8,400	7,900	9,600	8,700	8,100
130	8,500	7,900	7,400	9,000	8,200	7,700	9,300	8,500	7,900
135	8,300	7,600	7,300	8,700	8,000	7,500	9,100	8,300	7,800
140	8,000	7,400	7,100	8,500	7,800	7,300	8,900	8,100	7,600
145	7,800	7,200	6,900	8,200	7,600	7,200	8,600	7,900	7,400
150	7,500	7,000	6,800	8,000	7,400	7,000	8,400	7,700	7,300
155	7,300	6,800	6,600	7,700	7,200	6,900	8,200	7,500	7,100
160	7,000	6,600	6,400	7,500	7,000	6,700	8,000	7,300	7,000
165	6,800	6,400	6,300	7,300	6,800	6,600	7,700	7,200	6,800
170	6,500	6,200	6,100	7,100	6,600	6,400	7,500	7,000	6,700
175	6,300	6,100	6,000	6,800	6,400	6,300	7,300	6,800	6,500
180	6,100	5,900	5,900	6,600	6,300	6,100	7,100	6,600	6,400
185	5,900	5,700	5,700	6,400	6,100	6,000	6,900	6,500	6,300
190	5,800	5,600	5,600	6,200	6,000	5,900	6,700	6,300	6,200
195	5,600	5,500	5,500	6,000	5,800	5,800	6,500	6,200	6,000
200	5,400	5,400	5,400	5,900	5,700	5,700	6,200	6,000	5,900
205	5,300	5,300		5,700	5,600	5,600	5,700	5,900	5,800
210	5,200			5,600	5,400	5,400	5,200	5,600	5,700
215				5,400	5,300	5,300	4,800	5,200	5,400
220				5,300	5,300		4,300	4,700	4,900
225				5,000	5,200		3,900	4,300	4,400
230							3,600	3,800	3,800
235							3,200	3,400	3,300
240							2,800	3,000	
245							2,500		
Min Angle	18.0	26.0	16.5	22.0	12.5	13.5	14.5	21.0	23.0
Max Rad. Capacity	215.0	210.0	203.1	230.0	228.6	219.6	250.0	245.0	236.2
	0	0	0	0	0	0	0	0	0

1072120



PORTLAND OFFICE: 503.283.3111
 SEATTLE OFFICE: 206.784.1054
WWW.NESSCAMPBELL.COM

Rated Lifting Capacities in Pounds

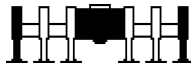

Full

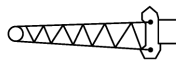

117ft Offset Fly



102,000 lbs



Radius (ft)	Boom Length (ft)											
	Fly Offset											
	44.3				73.5				103.8			
	2°	15°	30°	45°	2°	15°	30°	45°	2°	15°	30°	45°
25	15,800											
30	14,500				14,800							
35	13,300				14,800				13,100			
40	12,300	11,900			13,800				13,100			
45	11,400	11,000			12,900	12,000			13,100			
50	10,600	10,300	10,000		12,100	11,300			13,100			
55	9,900	9,600	9,400		11,300	10,700			12,600	11,500		
60	9,200	9,000	8,800		10,600	10,000	9,500		11,900	10,900		
65	8,600	8,400	8,300	8,200	10,000	9,500	9,000		11,300	10,400		
70	8,100	7,900	7,800	7,800	9,400	9,000	8,600	8,300	10,700	9,900	9,200	
75	7,600	7,500	7,400	7,300	8,900	8,500	8,200	7,900	10,100	9,400	8,800	
80	7,000	6,900	6,900	6,900	8,400	8,100	7,800	7,600	9,600	9,000	8,400	8,000
85	6,600	6,500	6,400	6,400	8,000	7,700	7,400	7,200	9,100	8,500	8,000	7,700
90	6,100	6,100	6,000	6,000	7,500	7,200	7,000	6,800	8,700	8,200	7,700	7,400
95	5,600	5,600	5,600	5,700	7,100	6,800	6,600	6,500	8,300	7,800	7,400	7,100
100	5,200	5,200	5,300	5,300	6,700	6,400	6,200	6,100	7,900	7,500	7,000	6,800
105	4,800	4,900	4,900	4,900	6,300	6,100	5,900	5,800	7,500	7,100	6,700	6,500
110	4,500	4,500	4,600	4,600	5,900	5,700	5,600	5,500	7,100	6,700	6,400	6,200
115	4,200	4,200	4,200	4,300	5,500	5,400	5,300	5,200	6,800	6,400	6,100	5,900
120	3,900	3,900	3,900	4,000	5,200	5,000	5,000	4,900	6,400	6,100	5,800	5,700
125	3,600	3,600	3,700	3,700	4,800	4,700	4,700	4,700	6,100	5,800	5,600	5,400
130	3,300	3,400	3,400	3,500	4,500	4,500	4,400	4,400	5,700	5,500	5,300	5,200
135	3,100	3,100	3,200		4,300	4,200	4,200	4,200	5,400	5,200	5,000	4,900
140	2,900	2,900	2,900		4,000	3,900	3,900	3,900	5,100	4,900	4,800	4,700
145	2,600	2,700			3,700	3,700	3,700	3,700	4,800	4,700	4,500	4,500
150	2,500	2,500			3,500	3,500	3,500	3,500	4,600	4,400	4,300	4,300
155					3,300	3,300	3,300	3,300	4,300	4,200	4,100	4,100
160					3,100	3,100	3,100		4,100	4,000	3,900	3,900
165					2,900	2,900	2,900		3,900	3,800	3,700	3,700
170					2,700	2,700	2,700		3,700	3,600	3,500	3,600
175					2,600	2,600			3,500	3,400	3,400	3,400
180									3,300	3,200	3,200	3,200
185									3,100	3,100	3,100	
190									3,000	2,900	2,900	
195									2,800	2,800	2,800	
200									2,700	2,600	2,700	
205									2,500	2,500		
Min Angle	0.0	0.0	0.0	0.0	13.5	16.0	24.0	29.5	15.0	17.0	23.5	27.5
Max Rad. Capacity	152.9	152.4	149.4	144.0	180.0	180.0	175.0	166.2	210.0	210.0	205.0	196.4
	2,400	2,400	2,500	2,700	0	0	0	0	0	0	0	0

1071130



PORTLAND OFFICE: 503.283.3111
 SEATTLE OFFICE: 206.784.1054
WWW.NESSCAMPBELL.COM

Rated Lifting Capacities in Pounds

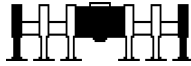

Full

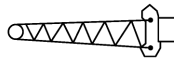

117ft Offset Fly

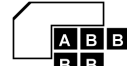

102,000 lbs



Radius (ft)	Boom Length (ft)											
	Fly Offset											
	134.9				167.1				183.6			
	2°	15°	30°	45°	2°	15°	30°	45°	2°	15°	30°	45°
45	11,000											
50	11,000				8,600							
55	11,000				8,600							
60	11,000				8,600				7,900			
65	11,000	10,900			8,600				7,900			
70	11,000	10,600			8,600	8,500			7,900			
75	11,000	10,200			8,600	8,500			7,900	7,800		
80	10,700	9,700	8,900		8,600	8,500			7,900	7,800		
85	10,200	9,300	8,600		8,600	8,500			7,900	7,800		
90	9,800	8,900	8,300	7,800	8,600	8,500	8,400		7,900	7,800		
95	9,300	8,600	8,000	7,500	8,600	8,500	8,400		7,900	7,800	7,700	
100	8,900	8,200	7,700	7,300	8,600	8,500	8,200	7,600	7,900	7,800	7,700	
105	8,600	7,900	7,400	7,000	8,600	8,500	7,900	7,400	7,900	7,800	7,700	7,500
110	8,200	7,600	7,100	6,700	8,600	8,300	7,600	7,200	7,900	7,800	7,700	7,400
115	7,900	7,300	6,800	6,500	8,600	8,000	7,400	6,900	7,900	7,800	7,600	7,200
120	7,500	7,000	6,500	6,200	8,500	7,800	7,100	6,700	7,900	7,800	7,400	6,900
125	7,200	6,700	6,300	6,000	8,200	7,500	6,900	6,500	7,900	7,800	7,200	6,700
130	6,900	6,400	6,000	5,800	7,900	7,200	6,600	6,300	7,900	7,600	6,900	6,500
135	6,600	6,100	5,800	5,600	7,600	6,900	6,400	6,100	7,900	7,300	6,700	6,300
140	6,300	5,900	5,500	5,400	7,300	6,700	6,200	5,900	7,700	7,000	6,500	6,100
145	6,000	5,600	5,300	5,100	7,000	6,400	6,000	5,700	7,400	6,800	6,200	5,900
150	5,700	5,300	5,100	4,900	6,700	6,200	5,700	5,500	7,100	6,500	6,000	5,700
155	5,400	5,100	4,900	4,700	6,400	5,900	5,500	5,300	6,900	6,300	5,800	5,600
160	5,100	4,900	4,700	4,500	6,200	5,700	5,300	5,100	6,600	6,100	5,600	5,400
165	4,900	4,600	4,500	4,400	5,900	5,500	5,100	4,900	6,400	5,900	5,400	5,200
170	4,600	4,400	4,300	4,200	5,600	5,200	4,900	4,800	6,100	5,600	5,200	5,000
175	4,400	4,200	4,100	4,000	5,400	5,000	4,700	4,600	5,900	5,400	5,100	4,900
180	4,200	4,000	3,900	3,900	5,100	4,800	4,600	4,400	5,600	5,200	4,900	4,700
185	4,000	3,900	3,800	3,700	4,800	4,600	4,400	4,300	5,400	5,000	4,700	4,600
190	3,800	3,700	3,600	3,600	4,500	4,400	4,200	4,100	5,100	4,800	4,500	4,400
195	3,700	3,500	3,500	3,500	4,100	4,300	4,100	4,000	4,800	4,600	4,400	4,300
200	3,500	3,400	3,300	3,300	3,800	4,100	3,900	3,900	4,500	4,500	4,200	4,100
205	3,300	3,200	3,200	3,200	3,500	3,800	3,800	3,700	4,100	4,300	4,100	4,000
210	3,200	3,100	3,100		3,200	3,500	3,700	3,600	3,800	4,100	3,900	3,900
215	3,000	3,000	2,900		2,900	3,200	3,400	3,500	3,600	3,800	3,800	3,800
220	2,900	2,800	2,800		2,700	2,900	3,100	3,200	3,300	3,500	3,700	3,600
225	2,700	2,700	2,700		2,400	2,600	2,800	2,900	3,000	3,200	3,400	3,500
230	2,500	2,600	2,600		2,200	2,400	2,500	2,600	2,800	3,000	3,200	3,200
235	2,400	2,400				2,100	2,300	2,300	2,500	2,700	2,900	3,000
240									2,300	2,500	2,600	2,700
245									2,100	2,200	2,400	2,400
250											2,100	2,200
Min Angle	18.0	20.0	25.0	26.0	41.0	41.5	42.0	41.5	42.5	43.0	43.5	43.0
Max Rad. Capacity	240.0	240.0	235.0	227.6	233.3	237.5	240.0	240.0	246.7	250.0	252.5	253.3
Capacity	0	0	0	0	0	0	0	0	0	0	0	0

1071130



PORTLAND OFFICE: 503.283.3111
 SEATTLE OFFICE: 206.784.1054
WWW.NESSCAMPBELL.COM

Rated Lifting Capacities in Pounds

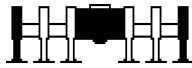

Full

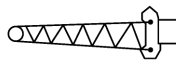

117ft Offset Fly



102,000 lbs



Radius (ft)	Boom Length (ft)			
	Fly Offset			
	200.1			
	2°	15°	30°	45°
60	6,700			
65	6,700			
70	6,700			
75	6,700			
80	6,700	6,600		
85	6,700	6,600		
90	6,700	6,600		
95	6,700	6,600	6,400	
100	6,700	6,600	6,400	
105	6,700	6,600	6,400	
110	6,700	6,600	6,400	6,300
115	6,700	6,600	6,400	6,300
120	6,700	6,600	6,400	6,300
125	6,700	6,600	6,400	6,300
130	6,700	6,600	6,400	6,300
135	6,700	6,600	6,400	6,300
140	6,700	6,600	6,400	6,300
145	6,700	6,600	6,400	6,100
150	6,700	6,600	6,300	5,900
155	6,700	6,600	6,100	5,800
160	6,700	6,400	5,900	5,600
165	6,700	6,200	5,700	5,400
170	6,500	6,000	5,500	5,300
175	6,300	5,800	5,400	5,100
180	6,100	5,600	5,200	4,900
185	5,800	5,400	5,000	4,800
190	5,600	5,200	4,800	4,600
195	5,400	5,000	4,700	4,500
200	5,100	4,800	4,500	4,400
205	4,700	4,600	4,400	4,200
210	4,200	4,500	4,200	4,100
215	3,800	4,300	4,100	4,000
220	3,300	3,900	3,900	3,900
225	2,900	3,400	3,800	3,800
230	2,500	3,000	3,500	3,600
235	2,100	2,600	3,000	3,200
240		2,200	2,600	2,800
245			2,200	2,300
Min Angle	50.0	50.0	50.5	50.5
Max Rad.	236.7	243.3	247.5	248.8
Capacity	0	0	0	0

1071130



PORTLAND OFFICE: 503.283.3111
 SEATTLE OFFICE: 206.784.1054
WWW.NESSCAMPBELL.COM

Rated Lifting Capacities in Pounds

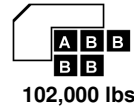
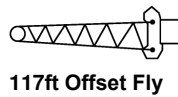
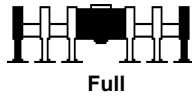

Radius (ft)	Boom Length (ft)											
	Fly Offset											
	44.3				58.9				89.1			
	2°	15°	30°	45°	2°	15°	30°	45°	2°	15°	30°	45°
25	15,800				16,400							
30	14,500				15,300							
35	13,300				14,100				15,600			
40	12,300	11,900			13,100	12,400			14,500			
45	11,400	11,000			12,200	11,600			13,600			
50	10,600	10,300	10,000		11,400	10,800			12,800	11,800		
55	9,900	9,600	9,400		10,600	10,200	9,800		12,000	11,100		
60	9,200	9,000	8,800		10,000	9,600	9,200		11,300	10,500		
65	8,600	8,400	8,300	8,200	9,400	9,000	8,700	8,500	10,700	10,000	9,400	
70	8,100	7,900	7,800	7,800	8,800	8,500	8,200	8,100	10,100	9,500	8,900	
75	7,600	7,500	7,400	7,300	8,300	8,000	7,800	7,700	9,600	9,000	8,500	8,200
80	7,000	6,900	6,900	6,900	7,800	7,600	7,400	7,300	9,100	8,500	8,100	7,800
85	6,600	6,500	6,400	6,400	7,300	7,100	6,900	6,900	8,600	8,100	7,700	7,500
90	6,100	6,100	6,000	6,000	6,800	6,700	6,500	6,500	8,200	7,800	7,400	7,200
95	5,600	5,600	5,600	5,700	6,400	6,300	6,200	6,100	7,800	7,400	7,000	6,800
100	5,200	5,200	5,300	5,300	6,000	5,900	5,800	5,800	7,300	7,000	6,700	6,500
105	4,800	4,900	4,900	4,900	5,600	5,500	5,400	5,400	6,900	6,600	6,300	6,200
110	4,500	4,500	4,600	4,600	5,200	5,100	5,100	5,100	6,600	6,300	6,000	5,900
115	4,200	4,200	4,200	4,300	4,800	4,800	4,800	4,800	6,200	6,000	5,700	5,600
120	3,900	3,900	3,900	4,000	4,500	4,500	4,500	4,500	5,800	5,600	5,400	5,300
125	3,600	3,600	3,700	3,700	4,200	4,200	4,200	4,200	5,500	5,300	5,200	5,100
130	3,300	3,400	3,400	3,500	3,900	3,900	3,900	4,000	5,200	5,000	4,900	4,800
135	3,100	3,100	3,200		3,700	3,700	3,700	3,700	4,900	4,700	4,600	4,600
140	2,900	2,900	2,900		3,400	3,400	3,500	3,500	4,600	4,500	4,400	4,400
145	2,600	2,700			3,200	3,200	3,200		4,300	4,200	4,200	4,100
150	2,500	2,500			3,000	3,000	3,000		4,100	4,000	3,900	3,900
155					2,800	2,800	2,800		3,800	3,800	3,700	3,700
160					2,600	2,600			3,600	3,600	3,500	3,500
165									3,400	3,400	3,400	3,400
170									3,200	3,200	3,200	
175									3,000	3,000	3,000	
180									2,900	2,900	2,900	
185									2,700	2,700	2,700	
190									2,600	2,600		
Min Angle	0.0	0.0	0.0	0.0	14.0	17.0	25.5	30.0	14.5	17.0	24.0	27.0
Max Rad. Capacity	152.9	152.4	149.4	144.0	165.0	165.0	160.0	151.6	195.0	195.0	190.0	181.8
	2,400	2,400	2,500	2,700	0	0	0	0	0	0	0	0

1071140



PORTLAND OFFICE: 503.283.3111
 SEATTLE OFFICE: 206.784.1054
WWW.NESSCAMPBELL.COM

Rated Lifting Capacities in Pounds

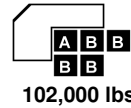
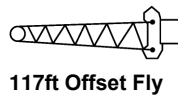
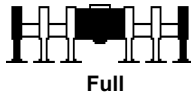

Radius (ft)	Boom Length (ft)											
	Fly Offset											
	120.3				152.4				169.0			
	2°	15°	30°	45°	2°	15°	30°	45°	2°	15°	30°	45°
40	14,400											
45	14,400											
50	14,000				11,500							
55	13,200				11,500				10,600			
60	12,500	11,300			11,500				10,600			
65	11,900	10,800			11,500	11,400			10,600			
70	11,300	10,300	9,500		11,500	11,000			10,600			
75	10,700	9,800	9,100		11,500	10,600			10,600	10,500		
80	10,200	9,400	8,700	8,200	11,300	10,100	9,200		10,600	10,500		
85	9,700	9,000	8,300	7,900	10,800	9,700	8,900		10,600	10,100		
90	9,300	8,600	8,000	7,600	10,300	9,300	8,500	8,000	10,600	9,700	8,800	
95	8,900	8,200	7,700	7,400	9,900	9,000	8,200	7,700	10,400	9,300	8,500	
100	8,500	7,900	7,400	7,100	9,500	8,600	8,000	7,500	9,900	9,000	8,200	7,700
105	8,100	7,600	7,100	6,800	9,100	8,300	7,700	7,300	9,600	8,700	7,900	7,400
110	7,800	7,200	6,800	6,500	8,700	8,000	7,400	7,000	9,200	8,400	7,700	7,200
115	7,400	6,900	6,500	6,200	8,400	7,700	7,100	6,700	8,900	8,100	7,400	7,000
120	7,000	6,600	6,200	6,000	8,100	7,400	6,900	6,500	8,500	7,800	7,200	6,700
125	6,700	6,300	6,000	5,800	7,800	7,100	6,600	6,300	8,200	7,500	6,900	6,500
130	6,400	6,000	5,700	5,500	7,400	6,800	6,400	6,100	7,900	7,200	6,700	6,300
135	6,100	5,700	5,400	5,300	7,100	6,600	6,100	5,900	7,600	7,000	6,400	6,100
140	5,700	5,400	5,200	5,100	6,800	6,300	5,900	5,700	7,300	6,700	6,200	5,900
145	5,400	5,200	5,000	4,800	6,500	6,100	5,700	5,500	7,000	6,400	6,000	5,700
150	5,200	4,900	4,700	4,600	6,300	5,800	5,500	5,300	6,700	6,200	5,800	5,500
155	4,900	4,700	4,500	4,400	6,000	5,600	5,200	5,100	6,500	6,000	5,600	5,300
160	4,700	4,500	4,300	4,300	5,700	5,300	5,000	4,900	6,200	5,700	5,400	5,100
165	4,400	4,200	4,100	4,100	5,400	5,100	4,800	4,700	5,900	5,500	5,200	5,000
170	4,200	4,000	3,900	3,900	5,200	4,900	4,600	4,500	5,700	5,300	5,000	4,800
175	4,000	3,900	3,800	3,700	4,900	4,700	4,500	4,400	5,400	5,100	4,800	4,600
180	3,800	3,700	3,600	3,600	4,700	4,500	4,300	4,200	5,200	4,900	4,600	4,500
185	3,600	3,500	3,400	3,400	4,500	4,300	4,100	4,000	5,000	4,700	4,400	4,300
190	3,400	3,300	3,300	3,300	4,300	4,100	4,000	3,900	4,800	4,500	4,300	4,200
195	3,300	3,200	3,200	3,200	4,100	3,900	3,800	3,800	4,600	4,300	4,100	4,000
200	3,100	3,000	3,000		3,900	3,800	3,700	3,600	4,400	4,100	4,000	3,900
205	2,900	2,900	2,900		3,800	3,600	3,500	3,500	4,200	4,000	3,800	3,800
210	2,800	2,800	2,800		3,500	3,500	3,400	3,400	4,000	3,800	3,700	3,700
215	2,700	2,600	2,700		3,300	3,300	3,300	3,300	3,800	3,700	3,600	3,500
220	2,500	2,500			3,000	3,200	3,100	3,200	3,600	3,500	3,400	3,400
225					2,700	2,900	3,000		3,400	3,400	3,300	3,300
230					2,500	2,700	2,800		3,100	3,300	3,200	3,200
235					2,300	2,400	2,500		2,900	3,100	3,100	3,100
240						2,200	2,300		2,600	2,800	2,900	
245									2,300	2,600	2,700	
250										2,200	2,400	
Min Angle	17.5	19.5	25.0	24.5	31.0	30.5	31.0	29.0	34.5	35.0	35.0	34.5
Max Rad. Capacity	225.0	225.0	220.0	213.0	240.0	245.0	245.0	243.3	248.8	253.3	255.0	253.0
	0	0	0	0	0	0	0	0	0	0	0	0

1071140



PORTLAND OFFICE: 503.283.3111
 SEATTLE OFFICE: 206.784.1054
WWW.NESSCAMPBELL.COM

Rated Lifting Capacities in Pounds

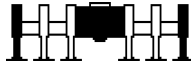

Full

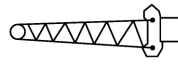

117ft Offset Fly



102,000 lbs



Radius (ft)	Boom Length (ft)			
	Fly Offset			
	185.5			
	2°	15°	30°	45°
60	9,000			
65	9,000			
70	9,000			
75	9,000			
80	9,000	9,000		
85	9,000	9,000		
90	9,000	9,000		
95	9,000	9,000	8,700	
100	9,000	9,000	8,400	
105	9,000	9,000	8,200	7,600
110	9,000	8,700	7,900	7,400
115	9,000	8,400	7,700	7,200
120	9,000	8,100	7,400	6,900
125	8,600	7,900	7,200	6,700
130	8,300	7,600	6,900	6,500
135	8,100	7,300	6,700	6,300
140	7,800	7,100	6,500	6,100
145	7,500	6,800	6,300	5,900
150	7,200	6,600	6,100	5,800
155	6,900	6,300	5,900	5,600
160	6,700	6,100	5,700	5,400
165	6,400	5,900	5,500	5,200
170	6,200	5,700	5,300	5,100
175	5,900	5,500	5,100	4,900
180	5,700	5,200	4,900	4,700
185	5,400	5,000	4,700	4,600
190	5,200	4,900	4,600	4,400
195	5,000	4,700	4,400	4,300
200	4,800	4,500	4,300	4,200
205	4,600	4,300	4,100	4,000
210	4,100	4,200	4,000	3,900
215	3,700	4,000	3,800	3,800
220	3,200	3,700	3,700	3,700
225	2,800	3,300	3,600	3,600
230	2,400	2,900	3,300	3,400
235		2,500	2,800	3,000
240		2,100	2,400	2,500
245				2,100
Min Angle	46.0	46.5	46.5	46.0
Max Rad.	235.0	241.3	245.0	246.3
Capacity	0	0	0	0

1071140



PORTLAND OFFICE: 503.283.3111
 SEATTLE OFFICE: 206.784.1054
WWW.NESSCAMPBELL.COM

Rated Lifting Capacities in Pounds

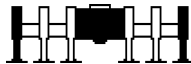

Full

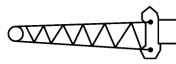

117ft Offset Fly

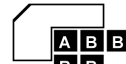

102,000 lbs



Radius (ft)	Boom Length (ft)											
	Fly Offset											
	44.3				73.5				103.8			
	2°	15°	30°	45°	2°	15°	30°	45°	2°	15°	30°	45°
25	15,800											
30	14,500				14,800							
35	13,300				14,800				13,100			
40	12,300	11,900			13,800				13,100			
45	11,400	11,000			12,900	12,000			13,100			
50	10,600	10,300	10,000		12,100	11,300			13,100			
55	9,900	9,600	9,400		11,300	10,700			12,600	11,500		
60	9,200	9,000	8,800		10,600	10,000	9,500		11,900	10,900		
65	8,600	8,400	8,300	8,200	10,000	9,500	9,000		11,300	10,400		
70	8,100	7,900	7,800	7,800	9,400	9,000	8,600	8,300	10,700	9,900	9,200	
75	7,600	7,500	7,400	7,300	8,900	8,500	8,200	7,900	10,100	9,400	8,800	
80	7,000	6,900	6,900	6,900	8,400	8,100	7,800	7,600	9,600	9,000	8,400	8,000
85	6,600	6,500	6,400	6,400	8,000	7,700	7,400	7,200	9,100	8,500	8,000	7,700
90	6,100	6,100	6,000	6,000	7,500	7,200	7,000	6,800	8,700	8,200	7,700	7,400
95	5,600	5,600	5,600	5,700	7,100	6,800	6,600	6,500	8,300	7,800	7,400	7,100
100	5,200	5,200	5,300	5,300	6,700	6,400	6,200	6,100	7,900	7,500	7,000	6,800
105	4,800	4,900	4,900	4,900	6,300	6,100	5,900	5,800	7,500	7,100	6,700	6,500
110	4,500	4,500	4,600	4,600	5,900	5,700	5,600	5,500	7,100	6,700	6,400	6,200
115	4,200	4,200	4,200	4,300	5,500	5,400	5,300	5,200	6,800	6,400	6,100	5,900
120	3,900	3,900	3,900	4,000	5,200	5,000	5,000	4,900	6,400	6,100	5,800	5,700
125	3,600	3,600	3,700	3,700	4,800	4,700	4,700	4,700	6,100	5,800	5,600	5,400
130	3,300	3,400	3,400	3,500	4,500	4,500	4,400	4,400	5,700	5,500	5,300	5,200
135	3,100	3,100	3,200		4,300	4,200	4,200	4,200	5,400	5,200	5,000	4,900
140	2,900	2,900	2,900		4,000	3,900	3,900	3,900	5,100	4,900	4,800	4,700
145	2,600	2,700			3,700	3,700	3,700	3,700	4,800	4,700	4,500	4,500
150	2,500	2,500			3,500	3,500	3,500	3,500	4,600	4,400	4,300	4,300
155					3,300	3,300	3,300	3,300	4,300	4,200	4,100	4,100
160					3,100	3,100	3,100		4,100	4,000	3,900	3,900
165					2,900	2,900	2,900		3,900	3,800	3,700	3,700
170					2,700	2,700	2,700		3,700	3,600	3,500	3,600
175					2,600	2,600			3,500	3,400	3,400	3,400
180									3,300	3,200	3,200	3,200
185									3,100	3,100	3,100	
190									3,000	2,900	2,900	
195									2,800	2,800	2,800	
200									2,700	2,600	2,700	
205									2,500	2,500		
Min Angle	0.0	0.0	0.0	0.0	13.5	16.0	24.0	29.5	15.0	17.0	23.5	27.5
Max Rad. Capacity	152.9	152.4	149.4	144.0	180.0	180.0	175.0	166.2	210.0	210.0	205.0	196.4
	2,400	2,400	2,500	2,700	0	0	0	0	0	0	0	0

1071150



PORTLAND OFFICE: 503.283.3111
 SEATTLE OFFICE: 206.784.1054
WWW.NESSCAMPBELL.COM

Rated Lifting Capacities in Pounds

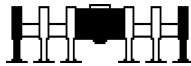

Full

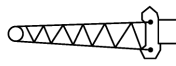

117ft Offset Fly

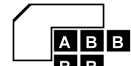

102,000 lbs



Radius (ft)	Boom Length (ft)											
	Fly Offset											
	119.4				135.4				152.0			
	2°	15°	30°	45°	2°	15°	30°	45°	2°	15°	30°	45°
40	12,800											
45	12,800				12,700							
50	12,800				12,700				11,900			
55	12,800				12,700				11,900			
60	12,500	11,300			12,700	11,700			11,900			
65	11,800	10,800			12,400	11,100			11,900	11,500		
70	11,200	10,300			11,800	10,700			11,900	11,000		
75	10,700	9,800	9,100		11,200	10,200	9,300		11,800	10,500		
80	10,200	9,400	8,700		10,700	9,800	8,900		11,200	10,100	9,200	
85	9,700	9,000	8,300	7,900	10,200	9,300	8,600	8,100	10,800	9,700	8,900	
90	9,300	8,600	8,000	7,600	9,800	9,000	8,300	7,800	10,300	9,300	8,500	8,000
95	8,800	8,200	7,700	7,300	9,400	8,600	8,000	7,500	9,900	9,000	8,200	7,700
100	8,400	7,900	7,400	7,000	9,000	8,300	7,700	7,300	9,500	8,600	8,000	7,500
105	8,100	7,600	7,100	6,800	8,600	7,900	7,400	7,000	9,100	8,300	7,700	7,300
110	7,700	7,200	6,800	6,500	8,200	7,600	7,100	6,700	8,700	8,000	7,400	7,000
115	7,400	6,900	6,500	6,200	7,900	7,300	6,800	6,500	8,400	7,700	7,100	6,700
120	7,000	6,600	6,200	6,000	7,600	7,000	6,500	6,200	8,100	7,400	6,900	6,500
125	6,700	6,300	5,900	5,700	7,200	6,700	6,300	6,000	7,800	7,100	6,600	6,300
130	6,300	6,000	5,700	5,500	6,900	6,400	6,000	5,800	7,400	6,800	6,400	6,100
135	6,000	5,700	5,400	5,300	6,600	6,100	5,800	5,600	7,100	6,600	6,100	5,800
140	5,700	5,400	5,200	5,000	6,300	5,900	5,600	5,400	6,800	6,300	5,900	5,600
145	5,400	5,100	4,900	4,800	6,000	5,600	5,300	5,100	6,500	6,000	5,700	5,400
150	5,100	4,900	4,700	4,600	5,700	5,400	5,100	4,900	6,200	5,800	5,400	5,200
155	4,900	4,700	4,500	4,400	5,400	5,100	4,900	4,700	6,000	5,500	5,200	5,000
160	4,600	4,400	4,300	4,200	5,100	4,900	4,700	4,600	5,700	5,300	5,000	4,900
165	4,400	4,200	4,100	4,100	4,900	4,700	4,500	4,400	5,400	5,100	4,800	4,700
170	4,200	4,000	3,900	3,900	4,700	4,400	4,300	4,200	5,200	4,900	4,600	4,500
175	4,000	3,800	3,700	3,700	4,400	4,200	4,100	4,000	4,900	4,700	4,400	4,300
180	3,800	3,700	3,600	3,600	4,200	4,100	3,900	3,900	4,700	4,500	4,300	4,200
185	3,600	3,500	3,400	3,400	4,000	3,900	3,800	3,700	4,500	4,300	4,100	4,000
190	3,400	3,300	3,300	3,300	3,800	3,700	3,600	3,600	4,300	4,100	3,900	3,900
195	3,200	3,200	3,100	3,200	3,700	3,500	3,500	3,500	4,100	3,900	3,800	3,800
200	3,100	3,000	3,000		3,500	3,400	3,300	3,300	3,900	3,800	3,700	3,600
205	2,900	2,900	2,900		3,300	3,200	3,200	3,200	3,800	3,600	3,500	3,500
210	2,800	2,700	2,700		3,200	3,100	3,100		3,600	3,500	3,400	3,400
215	2,600	2,600	2,600		3,000	3,000	2,900		3,400	3,300	3,300	3,300
220	2,500	2,500			2,900	2,800	2,800		3,300	3,200	3,100	3,200
225					2,800	2,700	2,700		3,100	3,100	3,000	
230					2,600	2,600	2,600		3,000	2,900	2,900	
235					2,500	2,500			2,900	2,800	2,800	
240									2,800	2,700	2,700	
245									2,600	2,600	2,600	
250									2,500	2,500		
255									2,400			
Min Angle	16.5	18.5	24.0	26.0	18.0	20.0	25.0	24.0	18.5	22.0	18.5	22.0
Max Rad.	225.0	225.0	220.0	212.0	240.0	240.0	235.0	228.1	255.8	255.0	253.6	244.6
Capacity	0	0	0	0	0	0	0	0	0	0	0	0

1071150



PORTLAND OFFICE: 503.283.3111
 SEATTLE OFFICE: 206.784.1054
WWW.NESSCAMPBELL.COM

Rated Lifting Capacities in Pounds

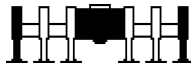

Full

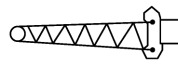

117ft Offset Fly

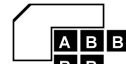

102,000 lbs



Radius (ft)	Boom Length (ft)			
	Fly Offset			
	168.5			
	2°	15°	30°	45°
50	10,200			
55	10,200			
60	10,200			
65	10,200			
70	10,200	10,100		
75	10,200	10,100		
80	10,200	10,100		
85	10,200	10,100	9,100	
90	10,200	9,700	8,800	
95	10,200	9,300	8,500	7,900
100	9,900	9,000	8,200	7,700
105	9,500	8,700	7,900	7,400
110	9,200	8,300	7,700	7,200
115	8,800	8,100	7,400	7,000
120	8,500	7,800	7,200	6,700
125	8,200	7,500	6,900	6,500
130	7,900	7,200	6,700	6,300
135	7,600	7,000	6,400	6,100
140	7,300	6,700	6,200	5,900
145	7,000	6,400	6,000	5,700
150	6,700	6,200	5,800	5,500
155	6,500	6,000	5,600	5,300
160	6,200	5,700	5,400	5,100
165	5,900	5,500	5,200	5,000
170	5,700	5,300	5,000	4,800
175	5,400	5,100	4,800	4,600
180	5,200	4,900	4,600	4,500
185	5,000	4,700	4,400	4,300
190	4,800	4,500	4,300	4,200
195	4,500	4,300	4,100	4,000
200	4,400	4,100	4,000	3,900
205	4,200	4,000	3,800	3,800
210	4,000	3,800	3,700	3,600
215	3,800	3,700	3,500	3,500
220	3,700	3,500	3,400	3,400
225	3,500	3,400	3,300	3,300
230	3,400	3,300	3,200	3,200
235	3,000	3,100	3,100	3,100
240	2,600	3,000	3,000	
245	2,300	2,600	2,800	
250		2,200	2,400	
Min Angle	34.0	34.5	34.5	33.5
Max Rad.	250.0	253.3	255.0	253.8
Capacity	0	0	0	0

1071150



PORTLAND OFFICE: 503.283.3111
 SEATTLE OFFICE: 206.784.1054
WWW.NESSCAMPBELL.COM

Rated Lifting Capacities in Pounds

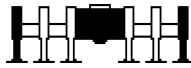

Full

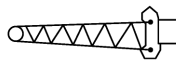

117ft Hydraulic Offset Fly



102,000 lbs



Radius (ft)	Boom Length (ft)											
	Fly Offset											
	44.3			73.5			103.8			134.9		
	2°-15°	15°-30°	30°-45°	2°-15°	15°-30°	30°-45°	2°-15°	15°-30°	30°-45°	2°-15°	15°-30°	30°-45°
25	15,800											
30	14,500			14,800								
35	12,800	12,800		14,800			13,100					
40	11,900	11,900		12,900	12,900		13,100					
45	11,000	11,000		12,000	12,000		13,100			11,000		
50	10,300	10,000	10,000	11,300	11,300		12,200	12,200		11,000		
55	9,600	9,400	9,400	10,700	10,100	10,100	11,500	11,500		11,000		
60	9,000	8,800	8,700	10,000	9,500	9,500	10,900	10,900		10,900	10,900	
65	8,400	8,300	8,200	9,500	9,000	8,700	10,400	9,600	9,600	10,900	10,900	
70	7,900	7,800	7,800	9,000	8,600	8,300	9,900	9,200	9,200	10,600	10,600	
75	7,500	7,400	7,300	8,500	8,200	7,900	9,400	8,800	8,400	10,200	9,300	9,300
80	6,900	6,900	6,900	8,100	7,800	7,600	9,000	8,400	8,000	9,700	8,900	8,900
85	6,500	6,400	6,400	7,700	7,400	7,200	8,500	8,000	7,700	9,300	8,600	8,100
90	6,100	6,000	6,000	7,200	7,000	6,800	8,200	7,700	7,400	8,900	8,300	7,800
95	5,600	5,600	5,600	6,800	6,600	6,500	7,800	7,400	7,100	8,600	8,000	7,500
100	5,200	5,200	5,300	6,400	6,200	6,100	7,500	7,000	6,800	8,200	7,700	7,300
105	4,800	4,900	4,900	6,100	5,900	5,800	7,100	6,700	6,500	7,900	7,400	7,000
110	4,500	4,500	4,600	5,700	5,600	5,500	6,700	6,400	6,200	7,600	7,100	6,700
115	4,200	4,200	4,200	5,400	5,300	5,200	6,400	6,100	5,900	7,300	6,800	6,500
120	3,900	3,900	3,900	5,000	5,000	4,900	6,100	5,800	5,700	7,000	6,500	6,200
125	3,600	3,600	3,700	4,700	4,700	4,700	5,800	5,600	5,400	6,700	6,300	6,000
130	3,300	3,400	3,400	4,500	4,400	4,400	5,500	5,300	5,200	6,400	6,000	5,800
135	3,100	3,100	3,200	4,200	4,200	4,200	5,200	5,000	4,900	6,100	5,800	5,600
140	2,900	2,900	2,900	3,900	3,900	3,900	4,900	4,800	4,700	5,900	5,500	5,400
145	2,600	2,700		3,700	3,700	3,700	4,700	4,500	4,500	5,600	5,300	5,100
150	2,500	2,500		3,500	3,500	3,500	4,400	4,300	4,300	5,300	5,100	4,900
155				3,300	3,300	3,300	4,200	4,100	4,100	5,100	4,900	4,700
160				3,100	3,100	3,100	4,000	3,900	3,900	4,900	4,700	4,500
165				2,900	2,900	2,900	3,800	3,700	3,700	4,600	4,500	4,400
170				2,700	2,700		3,600	3,500	3,500	4,400	4,300	4,200
175				2,600			3,400	3,400	3,400	4,200	4,100	4,000
180							3,200	3,200	3,200	4,000	3,900	3,900
185							3,100	3,100	3,100	3,900	3,800	3,700
190							2,900	2,900	2,900	3,700	3,600	3,600
195							2,800	2,800	2,800	3,500	3,500	3,500
200							2,600	2,600		3,400	3,300	3,300
205							2,500			3,200	3,200	3,200
210										3,100	3,100	3,100
215										3,000	2,900	2,900
220										2,800	2,800	2,800
225										2,700	2,700	2,700
230										2,500	2,600	
235										2,400		
Min Angle	0.0	0.0	0.0	13.5	24.0	29.5	15.0	23.5	27.5	18.0	25.0	26.0
Max Rad. Capacity	152.9	152.4	149.4	180.0	175.0	166.2	210.0	205.0	196.4	240.0	235.0	227.6
	2,400	2,400	2,500	0	0	0	0	0	0	0	0	0

1072130



PORTLAND OFFICE: 503.283.3111
 SEATTLE OFFICE: 206.784.1054
WWW.NESSCAMPBELL.COM

Rated Lifting Capacities in Pounds

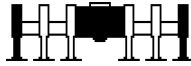

Full

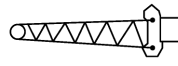

117ft Hydraulic Offset Fly



102,000 lbs



Radius (ft)	Boom Length (ft)								
	Fly Offset								
	167.1			183.6			200.1		
	2°-15°	15°-30°	30°-45°	2°-15°	15°-30°	30°-45°	2°-15°	15°-30°	30°-45°
50	8,600								
55	8,600								
60	8,600			7,900			6,700		
65	8,500	8,500		7,900			6,700		
70	8,500	8,500		7,800	7,800		6,600	6,600	
75	8,500	8,500		7,800	7,800		6,600	6,600	
80	8,500	8,500		7,800	7,800		6,600	6,600	
85	8,500	8,400	8,400	7,800	7,600	7,600	6,600	6,600	
90	8,500	8,400	8,400	7,800	7,600	7,600	6,600	6,600	
95	8,500	8,400	7,900	7,800	7,600	7,600	6,600	6,400	6,400
100	8,500	8,200	7,600	7,800	7,600	7,400	6,600	6,400	6,400
105	8,500	7,900	7,400	7,800	7,600	7,400	6,600	6,400	6,200
110	8,300	7,600	7,200	7,800	7,600	7,400	6,600	6,400	6,200
115	8,000	7,400	6,900	7,800	7,600	7,200	6,600	6,400	6,200
120	7,800	7,100	6,700	7,800	7,400	6,900	6,600	6,400	6,200
125	7,500	6,900	6,500	7,800	7,200	6,700	6,600	6,400	6,200
130	7,200	6,600	6,300	7,600	6,900	6,500	6,600	6,400	6,200
135	6,900	6,400	6,100	7,300	6,700	6,300	6,600	6,400	6,200
140	6,700	6,200	5,900	7,000	6,500	6,100	6,600	6,400	6,200
145	6,400	6,000	5,700	6,800	6,200	5,900	6,600	6,400	6,100
150	6,200	5,700	5,500	6,500	6,000	5,700	6,600	6,300	5,900
155	5,900	5,500	5,300	6,300	5,800	5,600	6,600	6,100	5,800
160	5,700	5,300	5,100	6,100	5,600	5,400	6,400	5,900	5,600
165	5,500	5,100	4,900	5,900	5,400	5,200	6,200	5,700	5,400
170	5,200	4,900	4,800	5,600	5,200	5,000	6,000	5,500	5,300
175	5,000	4,700	4,600	5,400	5,100	4,900	5,800	5,400	5,100
180	4,800	4,600	4,400	5,200	4,900	4,700	5,600	5,200	4,900
185	4,600	4,400	4,300	5,000	4,700	4,600	5,400	5,000	4,800
190	4,400	4,200	4,100	4,800	4,500	4,400	5,200	4,800	4,600
195	4,100	4,100	4,000	4,600	4,400	4,300	5,000	4,700	4,500
200	3,800	3,900	3,900	4,500	4,200	4,100	4,800	4,500	4,400
205	3,500	3,800	3,700	4,100	4,100	4,000	4,600	4,400	4,200
210	3,200	3,500	3,600	3,800	3,900	3,900	4,200	4,200	4,100
215	2,900	3,200	3,400	3,600	3,800	3,800	3,800	4,100	4,000
220	2,700	2,900	3,100	3,300	3,500	3,600	3,300	3,900	3,900
225	2,400	2,600	2,800	3,000	3,200	3,400	2,900	3,400	3,800
230	2,200	2,400	2,500	2,800	3,000	3,200	2,500	3,000	3,500
235		2,100	2,300	2,500	2,700	2,900	2,100	2,600	3,000
240				2,300	2,500	2,600		2,200	2,600
245				2,100	2,200	2,400			2,200
250						2,100			
Min Angle	41.0	41.5	41.5	42.5	43.0	43.5	50.0	50.0	50.5
Max Rad. Capacity	233.3	237.5	240.0	246.7	250.0	252.5	236.7	243.3	247.5
	0	0	0	0	0	0	0	0	0

1072130



PORTLAND OFFICE: 503.283.3111
 SEATTLE OFFICE: 206.784.1054
WWW.NESSCAMPBELL.COM

Rated Lifting Capacities in Pounds

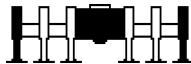

Full

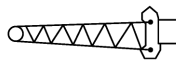

117ft Hydraulic Offset Fly



102,000 lbs



Radius (ft)	Boom Length (ft)											
	Fly Offset											
	44.3			58.9			89.1			120.3		
	2°-15°	15°-30°	30°-45°	2°-15°	15°-30°	30°-45°	2°-15°	15°-30°	30°-45°	2°-15°	15°-30°	30°-45°
25	15,800			16,400								
30	14,500			15,300								
35	12,800	12,800		13,300	13,300		15,600					
40	11,900	11,900		12,400	12,400		14,500			14,400		
45	11,000	11,000		11,600	11,600		12,500	12,500		14,400		
50	10,300	10,000	10,000	10,800	10,400	10,400	11,800	11,800		14,000		
55	9,600	9,400	9,400	10,200	9,800	9,800	11,100	11,100		11,900	11,900	
60	9,000	8,800	8,700	9,600	9,200	9,200	10,500	9,800	9,800	11,300	11,300	
65	8,400	8,300	8,200	9,000	8,700	8,500	10,000	9,400	9,400	10,800	9,900	9,900
70	7,900	7,800	7,800	8,500	8,200	8,100	9,500	8,900	8,500	10,300	9,500	9,500
75	7,500	7,400	7,300	8,000	7,800	7,700	9,000	8,500	8,200	9,800	9,100	9,100
80	6,900	6,900	6,900	7,600	7,400	7,300	8,500	8,100	7,800	9,400	8,700	8,200
85	6,500	6,400	6,400	7,100	6,900	6,900	8,100	7,700	7,500	9,000	8,300	7,900
90	6,100	6,000	6,000	6,700	6,500	6,500	7,800	7,400	7,200	8,600	8,000	7,600
95	5,600	5,600	5,600	6,300	6,200	6,100	7,400	7,000	6,800	8,200	7,700	7,400
100	5,200	5,200	5,300	5,900	5,800	5,800	7,000	6,700	6,500	7,900	7,400	7,100
105	4,800	4,900	4,900	5,500	5,400	5,400	6,600	6,300	6,200	7,600	7,100	6,800
110	4,500	4,500	4,600	5,100	5,100	5,100	6,300	6,000	5,900	7,200	6,800	6,500
115	4,200	4,200	4,200	4,800	4,800	4,800	6,000	5,700	5,600	6,900	6,500	6,200
120	3,900	3,900	3,900	4,500	4,500	4,500	5,600	5,400	5,300	6,600	6,200	6,000
125	3,600	3,600	3,700	4,200	4,200	4,200	5,300	5,200	5,100	6,300	6,000	5,800
130	3,300	3,400	3,400	3,900	3,900	3,900	5,000	4,900	4,800	6,000	5,700	5,500
135	3,100	3,100	3,200	3,700	3,700	3,700	4,700	4,600	4,600	5,700	5,400	5,300
140	2,900	2,900	2,900	3,400	3,400	3,500	4,500	4,400	4,400	5,400	5,200	5,100
145	2,600	2,700		3,200	3,200	3,200	4,200	4,200	4,100	5,200	5,000	4,800
150	2,500	2,500		3,000	3,000	3,000	4,000	3,900	3,900	4,900	4,700	4,600
155				2,800	2,800		3,800	3,700	3,700	4,700	4,500	4,400
160				2,600			3,600	3,500	3,500	4,500	4,300	4,300
165							3,400	3,400	3,400	4,200	4,100	4,100
170							3,200	3,200	3,200	4,000	3,900	3,900
175							3,000	3,000	3,000	3,900	3,800	3,700
180							2,900	2,900	2,900	3,700	3,600	3,600
185							2,700	2,700		3,500	3,400	3,400
190							2,600			3,300	3,300	3,300
195										3,200	3,200	3,200
200										3,000	3,000	3,000
205										2,900	2,900	2,900
210										2,800	2,800	2,800
215										2,600	2,600	
220										2,500		
Min Angle	0.0	0.0	0.0	14.0	25.5	30.0	14.5	24.0	27.0	17.5	25.0	24.5
Max Rad.	152.9	152.4	149.4	165.0	160.0	151.6	195.0	190.0	181.8	225.0	220.0	213.0
Capacity	2,400	2,400	2,500	0	0	0	0	0	0	0	0	0

1072140



PORTLAND OFFICE: 503.283.3111
 SEATTLE OFFICE: 206.784.1054
 WWW.NESSCAMPBELL.COM

Rated Lifting Capacities in Pounds

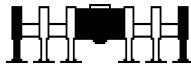

Full

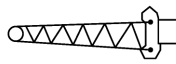

117ft Hydraulic Offset Fly

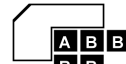

102,000 lbs



Radius (ft)	Boom Length (ft)								
	Fly Offset								
	152.4			169.0			185.5		
	2°-15°	15°-30°	30°-45°	2°-15°	15°-30°	30°-45°	2°-15°	15°-30°	30°-45°
50	11,500								
55	11,500			10,600					
60	11,500			10,600			9,000		
65	11,400	11,400		10,400	10,400		9,000		
70	11,000	11,000		10,400	10,400		8,900	8,900	
75	10,600	10,600		10,400	10,400		8,900	8,900	
80	10,100	9,200	9,200	10,400	10,400		8,900	8,900	
85	9,700	8,900	8,900	10,100	9,100	9,100	8,900	8,900	
90	9,300	8,500	8,000	9,700	8,800	8,800	8,900	8,700	8,700
95	9,000	8,200	7,700	9,300	8,500	7,900	8,900	8,700	8,700
100	8,600	8,000	7,500	9,000	8,200	7,700	8,900	8,400	7,800
105	8,300	7,700	7,300	8,700	7,900	7,400	8,900	8,200	7,600
110	8,000	7,400	7,000	8,400	7,700	7,200	8,700	7,900	7,400
115	7,700	7,100	6,700	8,100	7,400	7,000	8,400	7,700	7,200
120	7,400	6,900	6,500	7,800	7,200	6,700	8,100	7,400	6,900
125	7,100	6,600	6,300	7,500	6,900	6,500	7,900	7,200	6,700
130	6,800	6,400	6,100	7,200	6,700	6,300	7,600	6,900	6,500
135	6,600	6,100	5,900	7,000	6,400	6,100	7,300	6,700	6,300
140	6,300	5,900	5,700	6,700	6,200	5,900	7,100	6,500	6,100
145	6,100	5,700	5,500	6,400	6,000	5,700	6,800	6,300	5,900
150	5,800	5,500	5,300	6,200	5,800	5,500	6,600	6,100	5,800
155	5,600	5,200	5,100	6,000	5,600	5,300	6,300	5,900	5,600
160	5,300	5,000	4,900	5,700	5,400	5,100	6,100	5,700	5,400
165	5,100	4,800	4,700	5,500	5,200	5,000	5,900	5,500	5,200
170	4,900	4,600	4,500	5,300	5,000	4,800	5,700	5,300	5,100
175	4,700	4,500	4,400	5,100	4,800	4,600	5,500	5,100	4,900
180	4,500	4,300	4,200	4,900	4,600	4,500	5,200	4,900	4,700
185	4,300	4,100	4,000	4,700	4,400	4,300	5,000	4,700	4,600
190	4,100	4,000	3,900	4,500	4,300	4,200	4,900	4,600	4,400
195	3,900	3,800	3,800	4,300	4,100	4,000	4,700	4,400	4,300
200	3,800	3,700	3,600	4,100	4,000	3,900	4,500	4,300	4,200
205	3,600	3,500	3,500	4,000	3,800	3,800	4,300	4,100	4,000
210	3,500	3,400	3,400	3,800	3,700	3,700	4,100	4,000	3,900
215	3,300	3,300	3,300	3,700	3,600	3,500	3,700	3,800	3,800
220	3,000	3,100	3,100	3,500	3,400	3,400	3,200	3,700	3,700
225	2,700	2,900	3,000	3,400	3,300	3,300	2,800	3,300	3,600
230	2,500	2,700	2,800	3,100	3,200	3,200	2,400	2,900	3,300
235	2,300	2,400	2,500	2,900	3,100	3,100		2,500	2,800
240		2,200	2,200	2,600	2,800	2,900		2,100	2,400
245				2,300	2,600	2,700			
250					2,200	2,300			
Min Angle	31.0	30.5	29.0	34.5	35.0	34.5	46.0	46.5	46.5
Max Rad. Capacity	240.0	245.0	243.3	248.8	253.3	253.0	235.0	241.3	245.0
	0	0	0	0	0	0	0	0	0

1072140



PORTLAND OFFICE: 503.283.3111
 SEATTLE OFFICE: 206.784.1054
WWW.NESSCAMPBELL.COM

Rated Lifting Capacities in Pounds

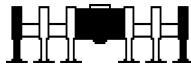

Full

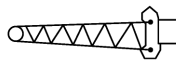

117ft Hydraulic Offset Fly



102,000 lbs



Radius (ft)	Boom Length (ft)											
	Fly Offset											
	44.3			73.5			103.8			119.4		
	2°-15°	15°-30°	30°-45°	2°-15°	15°-30°	30°-45°	2°-15°	15°-30°	30°-45°	2°-15°	15°-30°	30°-45°
25	15,800											
30	14,500			14,800								
35	12,800	12,800		14,800			13,100					
40	11,900	11,900		12,900	12,900		13,100			12,800		
45	11,000	11,000		12,000	12,000		13,100			12,800		
50	10,300	10,000	10,000	11,300	11,300		12,200	12,200		12,800		
55	9,600	9,400	9,400	10,700	10,100	10,100	11,500	11,500		11,900	11,900	
60	9,000	8,800	8,700	10,000	9,500	9,500	10,900	10,900		11,300	11,300	
65	8,400	8,300	8,200	9,500	9,000	8,700	10,400	9,600	9,600	10,800	10,800	
70	7,900	7,800	7,800	9,000	8,600	8,300	9,900	9,200	9,200	10,300	9,500	9,500
75	7,500	7,400	7,300	8,500	8,200	7,900	9,400	8,800	8,400	9,800	9,100	9,100
80	6,900	6,900	6,900	8,100	7,800	7,600	9,000	8,400	8,000	9,400	8,700	8,200
85	6,500	6,400	6,400	7,700	7,400	7,200	8,500	8,000	7,700	9,000	8,300	7,900
90	6,100	6,000	6,000	7,200	7,000	6,800	8,200	7,700	7,400	8,600	8,000	7,600
95	5,600	5,600	5,600	6,800	6,600	6,500	7,800	7,400	7,100	8,200	7,700	7,300
100	5,200	5,200	5,300	6,400	6,200	6,100	7,500	7,000	6,800	7,900	7,400	7,000
105	4,800	4,900	4,900	6,100	5,900	5,800	7,100	6,700	6,500	7,600	7,100	6,800
110	4,500	4,500	4,600	5,700	5,600	5,500	6,700	6,400	6,200	7,200	6,800	6,500
115	4,200	4,200	4,200	5,400	5,300	5,200	6,400	6,100	5,900	6,900	6,500	6,200
120	3,900	3,900	3,900	5,000	5,000	4,900	6,100	5,800	5,700	6,600	6,200	6,000
125	3,600	3,600	3,700	4,700	4,700	4,700	5,800	5,600	5,400	6,300	5,900	5,700
130	3,300	3,400	3,400	4,500	4,400	4,400	5,500	5,300	5,200	6,000	5,700	5,500
135	3,100	3,100	3,200	4,200	4,200	4,200	5,200	5,000	4,900	5,700	5,400	5,300
140	2,900	2,900	2,900	3,900	3,900	3,900	4,900	4,800	4,700	5,400	5,200	5,000
145	2,600	2,700		3,700	3,700	3,700	4,700	4,500	4,500	5,100	4,900	4,800
150	2,500	2,500		3,500	3,500	3,500	4,400	4,300	4,300	4,900	4,700	4,600
155				3,300	3,300	3,300	4,200	4,100	4,100	4,700	4,500	4,400
160				3,100	3,100	3,100	4,000	3,900	3,900	4,400	4,300	4,200
165				2,900	2,900	2,900	3,800	3,700	3,700	4,200	4,100	4,100
170				2,700	2,700		3,600	3,500	3,500	4,000	3,900	3,900
175				2,600			3,400	3,400	3,400	3,800	3,700	3,700
180							3,200	3,200	3,200	3,700	3,600	3,600
185							3,100	3,100	3,100	3,500	3,400	3,400
190							2,900	2,900	2,900	3,300	3,300	3,300
195							2,800	2,800	2,800	3,200	3,100	3,100
200							2,600	2,600		3,000	3,000	3,000
205							2,500			2,900	2,900	2,900
210										2,700	2,700	2,700
215										2,600	2,600	
220										2,500		
Min Angle	0.0	0.0	0.0	13.5	24.0	29.5	15.0	23.5	27.5	16.5	24.0	26.0
Max Rad.	152.9	152.4	149.4	180.0	175.0	166.2	210.0	205.0	196.4	225.0	220.0	212.0
Capacity	2,400	2,400	2,500	0	0	0	0	0	0	0	0	0

1072150



PORTLAND OFFICE: 503.283.3111
 SEATTLE OFFICE: 206.784.1054
WWW.NESSCAMPBELL.COM

Rated Lifting Capacities in Pounds

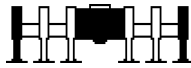

Full

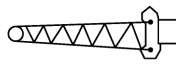

117ft Hydraulic Offset Fly



102,000 lbs



Radius (ft)	Boom Length (ft)								
	Fly Offset								
	135.4			152.0			168.5		
	2°-15°	15°-30°	30°-45°	2°-15°	15°-30°	30°-45°	2°-15°	15°-30°	30°-45°
45	12,700								
50	12,700			11,900			10,200		
55	12,700			11,900			10,200		
60	11,700	11,700		11,700	11,700		10,200		
65	11,100	11,100		11,500	11,500		10,000	10,000	
70	10,700	9,700	9,700	11,000	11,000		10,000	10,000	
75	10,200	9,300	9,300	10,500	9,500	9,500	10,000	10,000	
80	9,800	8,900	8,900	10,100	9,200	9,200	10,000	10,000	
85	9,300	8,600	8,100	9,700	8,900	8,300	10,000	9,100	9,100
90	9,000	8,300	7,800	9,300	8,500	8,000	9,700	8,800	8,800
95	8,600	8,000	7,500	9,000	8,200	7,700	9,300	8,500	7,900
100	8,300	7,700	7,300	8,600	8,000	7,500	9,000	8,200	7,700
105	7,900	7,400	7,000	8,300	7,700	7,300	8,700	7,900	7,400
110	7,600	7,100	6,700	8,000	7,400	7,000	8,300	7,700	7,200
115	7,300	6,800	6,500	7,700	7,100	6,700	8,100	7,400	7,000
120	7,000	6,500	6,200	7,400	6,900	6,500	7,800	7,200	6,700
125	6,700	6,300	6,000	7,100	6,600	6,300	7,500	6,900	6,500
130	6,400	6,000	5,800	6,800	6,400	6,100	7,200	6,700	6,300
135	6,100	5,800	5,600	6,600	6,100	5,800	7,000	6,400	6,100
140	5,900	5,600	5,400	6,300	5,900	5,600	6,700	6,200	5,900
145	5,600	5,300	5,100	6,000	5,700	5,400	6,400	6,000	5,700
150	5,400	5,100	4,900	5,800	5,400	5,200	6,200	5,800	5,500
155	5,100	4,900	4,700	5,500	5,200	5,000	6,000	5,600	5,300
160	4,900	4,700	4,600	5,300	5,000	4,900	5,700	5,400	5,100
165	4,700	4,500	4,400	5,100	4,800	4,700	5,500	5,200	5,000
170	4,400	4,300	4,200	4,900	4,600	4,500	5,300	5,000	4,800
175	4,200	4,100	4,000	4,700	4,400	4,300	5,100	4,800	4,600
180	4,100	3,900	3,900	4,500	4,300	4,200	4,900	4,600	4,500
185	3,900	3,800	3,700	4,300	4,100	4,000	4,700	4,400	4,300
190	3,700	3,600	3,600	4,100	3,900	3,900	4,500	4,300	4,200
195	3,500	3,500	3,500	3,900	3,800	3,800	4,300	4,100	4,000
200	3,400	3,300	3,300	3,800	3,700	3,600	4,100	4,000	3,900
205	3,200	3,200	3,200	3,600	3,500	3,500	4,000	3,800	3,800
210	3,100	3,100	3,100	3,500	3,400	3,400	3,800	3,700	3,600
215	3,000	2,900	2,900	3,300	3,300	3,300	3,700	3,500	3,500
220	2,800	2,800	2,800	3,200	3,100	3,100	3,500	3,400	3,400
225	2,700	2,700	2,700	3,100	3,000	3,000	3,400	3,300	3,300
230	2,600	2,600		2,900	2,900	2,900	3,300	3,200	3,200
235	2,500			2,800	2,800	2,800	3,000	3,100	3,100
240				2,700	2,700	2,700	2,600	3,000	3,000
245				2,600	2,600		2,300	2,600	2,800
250				2,500	2,500			2,200	2,300
Min Angle	18.0	25.0	24.0	22.0	18.5	22.0	34.0	34.5	33.5
Max Rad. Capacity	240.0	235.0	228.1	255.0	253.6	244.6	250.0	253.3	253.8
	0	0	0	0	0	0	0	0	0

1072150



PORTLAND OFFICE: 503.283.3111
 SEATTLE OFFICE: 206.784.1054
WWW.NESSCAMPBELL.COM

Rated Lifting Capacities in Pounds

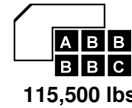
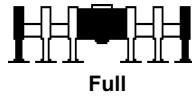

Boom Length (ft)											
Extend Mode											
Radius (ft)	44.3	58.9	59.4	59.9	73.5	74.0	75.0	75.9	88.7	89.1	89.6
	ALL	EM2, EM5	EM6	EM7	EM1, EM3, EM4	EM5	EM6	EM7	EM4	EM2	EM5
10	300,000	195,200	297,300	296,500	134,800	196,100	247,000	262,200	125,300	120,100	168,700
12	268,200	182,900	269,500	268,600	125,600	182,200	228,300	256,800	117,000	112,200	168,700
15	233,200	167,200	235,200	234,300	114,000	164,700	205,000	232,200	106,200	102,000	161,600
20	189,400	146,500	192,100	191,300	98,600	141,800	175,200	191,000	91,900	88,500	140,000
25	157,800	130,500	160,900	160,000	86,700	124,400	152,800	160,000	80,800	78,000	123,300
30	133,000	117,900	137,200	136,000	75,900	110,800	135,300	136,300	72,100	69,600	110,000
35	111,300	107,700	115,700	114,500	67,200	99,800	117,000	114,900	65,000	62,800	99,200
40		99,400	99,300	98,100	60,000	90,700	100,700	98,600	59,100	57,100	90,200
45		87,400	86,500	85,300	54,100	83,200	87,800	85,800	54,100	51,700	82,800
50		58,500	76,100	74,900	49,300	76,700	77,500	75,400	49,900	47,100	76,400
55					45,200	70,700	69,100	67,000	46,200	43,300	70,800
60					41,900	63,700	61,900	59,800	43,100	39,900	64,200
65						45,300	55,900	53,800	40,300	37,000	58,200
70									37,900	34,400	53,000
75									35,800	32,200	48,500
80									25,000	30,300	39,500
Unpinned		101,200	89,600	80,400	55,600	95,600	89,600	72,800	98,200	56,000	83,900
Min Angle	0.0	0.0	0.0	0.0	0.0	0.0	0.0	0.0	0.0	0.0	0.0
Max Rad. Capacity	35.7	50.4	50.8	51.3	65.0	65.5	66.4	67.4	80.1	80.6	81.1
Capacity	66,600	22,600	48,400	47,000	12,200	19,400	36,200	33,900	10,700	16,400	16,100

1080010



PORTLAND OFFICE: 503.283.3111
 SEATTLE OFFICE: 206.784.1054
WWW.NESSCAMPBELL.COM

Rated Lifting Capacities in Pounds

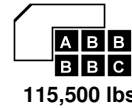
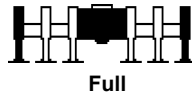

		Boom Length (ft)										
		Extend Mode										
Radius (ft)	91.0	92.5	103.8	104.2	105.7	107.6	119.4	120.3	120.3	122.2	124.1	134.9
	EM6	EM7	EM1, EM3	EM4	EM5	EM6	EM3	EM4	EM2	EM5	EM6	EM1
10	212,200	203,700										
12	212,200	203,700										
15	198,500	203,700	84,300	100,600	128,900							
20	169,700	184,600	76,600	97,200	128,900	172,300	66,300	92,800	77,300	120,900	129,700	54,700
25	148,100	158,700	67,600	86,600	124,700	153,000	66,300	91,000	69,400	120,900	112,800	54,700
30	131,200	135,000	60,300	78,100	111,500	136,500	64,000	82,700	62,100	118,300	99,400	54,700
35	116,700	113,700	54,400	71,000	100,600	115,300	58,200	75,900	56,200	107,800	88,400	52,400
40	100,500	97,500	49,500	65,000	91,600	99,200	53,300	70,000	51,200	98,900	79,400	47,800
45	87,700	84,800	45,300	60,000	83,900	86,500	48,900	64,900	46,900	88,000	71,900	43,800
50	77,400	74,400	41,700	55,700	77,400	76,200	45,100	60,500	43,200	77,900	65,400	40,400
55	69,000	66,000	38,700	51,900	70,800	67,800	41,800	56,700	40,000	69,400	59,800	37,400
60	61,900	58,900	36,000	48,600	63,800	60,700	38,900	53,300	37,200	62,400	55,000	34,800
65	55,800	52,800	33,400	45,700	57,700	54,600	36,400	50,300	34,700	56,300	50,700	32,400
70	50,700	47,700	31,000	43,000	52,500	49,500	34,100	47,600	32,500	51,300	47,000	30,400
75	46,100	43,200	28,900	40,700	48,000	45,000	32,100	45,200	30,500	46,800	43,600	28,500
80	42,200	39,100	27,100	38,700	44,100	41,000	30,300	42,900	28,700	42,800	40,100	26,800
85			25,400	36,800	40,100	37,000	28,600	40,900	27,100	38,800	36,100	25,300
90			24,000	35,200	36,600	33,600	27,100	38,000	25,600	35,300	32,800	23,900
95			21,700	25,500	33,600	30,600	25,700	34,900	24,300	32,300	29,700	22,600
100							24,500	32,300	23,100	29,600	27,000	21,400
105							23,400	29,900	21,800	27,200	24,600	20,300
110							21,600	24,700	20,800	25,000	22,500	19,300
115											20,600	18,400
120												17,600
125												16,800
Unpinned	74,300	60,200	60,700	86,100	75,900	61,400	66,300	77,900	60,700	61,800	44,600	54,700
Min Angle	0.0	0.0	0.0	0.0	0.0	0.0	0.0	0.0	0.0	0.0	0.0	0.0
Max Rad.	82.5	83.9	95.2	95.7	97.1	99.0	110.8	111.7	111.8	113.7	115.6	126.4
Capacity	26,900	23,600	9,400	9,100	12,800	19,000	7,900	7,300	11,300	9,500	13,200	6,700

1080010



PORTLAND OFFICE: 503.283.3111
 SEATTLE OFFICE: 206.784.1054
WWW.NESSCAMPBELL.COM

Rated Lifting Capacities in Pounds

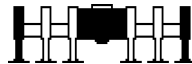

Full

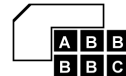

115,500 lbs



Boom Length (ft)											
Extend Mode											
Radius (ft)	135.4	136.8	152.0	152.4	153.4	167.1	168.5	169.0	183.6	185.5	200.1
	EM3	EM4	EM3	EM2	EM4	EM1	EM3	EM2	EM1	EM2	EM1
20	65,600	91,400									
25	65,600	91,400	65,300	57,200	73,000	41,200					
30	65,600	85,500	65,300	57,200	73,000	41,200	55,000	53,300	38,700	41,300	
35	61,700	79,100	64,100	54,500	73,000	41,200	55,000	53,300	38,700	41,300	33,000
40	57,000	73,500	59,600	49,800	69,700	41,200	55,000	52,200	38,700	41,300	33,000
45	52,800	68,600	55,600	45,700	63,800	41,200	55,000	48,200	38,700	41,300	33,000
50	49,100	64,100	52,100	41,900	58,600	40,500	53,500	44,300	38,700	41,300	33,000
55	45,800	60,400	48,900	38,800	54,100	37,600	50,500	41,300	38,700	41,300	33,000
60	42,700	57,000	46,100	36,000	50,100	34,900	47,600	38,500	37,200	40,200	33,000
65	40,100	54,000	43,200	33,600	46,500	32,500	44,300	36,100	34,800	37,800	33,000
70	37,700	51,300	40,800	31,300	43,300	30,400	41,400	33,800	32,700	35,600	33,000
75	35,600	48,100	38,700	29,300	40,500	28,500	38,700	31,800	30,700	33,700	32,600
80	33,700	44,100	36,700	27,500	37,900	26,700	36,400	30,000	29,000	31,900	30,800
85	31,900	40,100	34,900	25,900	35,600	25,100	34,200	28,300	27,300	30,200	29,100
90	30,300	36,600	33,300	24,400	33,400	23,700	32,200	26,800	25,800	28,600	27,600
95	28,900	33,700	31,700	23,000	31,500	22,200	30,300	25,300	24,400	27,200	26,200
100	27,600	31,000	30,400	21,600	29,700	21,000	28,600	24,000	23,200	25,800	25,000
105	26,300	28,500	29,100	20,400	27,500	19,900	27,100	22,800	21,900	24,400	23,800
110	25,200	26,400	27,100	19,300	25,300	18,900	25,600	21,400	20,800	23,000	22,400
115	24,200	24,400	25,100	18,400	23,400	17,900	24,100	20,400	19,800	21,600	21,400
120	23,300	22,600	23,300	17,400	21,600	17,000	22,300	19,500	18,900	20,400	20,400
125	20,900	21,000	21,700	16,600	20,000	16,200	20,700	18,600	18,000	19,400	19,600
130			20,200	15,800	18,500	15,400	19,200	17,700	17,200	18,300	18,700
135			18,800	15,000	17,300	14,600	17,800	17,000	16,400	17,100	17,700
140			17,600	14,300	16,000	14,000	16,700	16,200	15,700	15,900	16,700
145						13,300	15,500	15,500	15,000	14,700	15,600
150						12,700	14,500	14,400	14,400	13,600	14,500
155						12,100	13,500	13,400	13,800	12,600	13,500
160								10,200	13,200	11,700	12,500
165									12,500	10,800	11,700
170									11,700	10,000	10,800
175										9,300	10,100
180											9,400
185											8,700
Unpinned	65,600	63,400	65,200	57,200	63,200	41,200	55,000	53,300	38,700	41,300	33,000
Min Angle	0.0	0.0	0.0	0.0	0.0	0.0	0.0	0.0	0.0	0.0	14.0
Max Rad.	126.9	128.3	143.4	143.9	144.8	158.5	159.9	160.4	175.1	177.0	190.0
Capacity	6,400	5,300	4,500	7,000	3,500	4,000	2,900	4,800	2,500	2,900	0

1080010



PORTLAND OFFICE: 503.283.3111
 SEATTLE OFFICE: 206.784.1054
WWW.NESSCAMPBELL.COM

Rated Lifting Capacities in Pounds

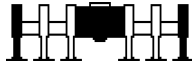

Full

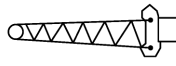

12ft Offset Fly
2° - 45°



115,500 lbs



Boom Length (ft)											
Extend Mode											
Radius (ft)	44.3	58.9	59.4	59.9	73.5	74.0	75.0	75.9	88.7	89.1	89.6
	ALL	EM2, EM5	EM6	EM7	EM1, EM3, EM4	EM5	EM6	EM7	EM4	EM2	EM5
10	69,600	69,500	69,500	69,500	69,400	69,400	69,400	69,400	69,400	69,400	69,300
12	69,600	69,500	69,500	69,500	69,400	69,400	69,400	69,400	69,400	69,400	69,300
15	69,600	69,500	69,500	69,500	69,400	69,400	69,400	69,400	69,400	69,400	69,300
20	69,600	69,500	69,500	69,500	69,400	69,400	69,400	69,400	69,400	69,400	69,300
25	69,600	69,500	69,500	69,500	69,400	69,400	69,400	69,400	69,400	69,400	69,300
30	66,700	69,500	69,500	69,500	64,100	69,400	69,400	69,400	63,700	62,300	69,300
35	61,800	69,400	69,500	69,500	57,500	69,400	69,400	69,400	57,200	56,000	69,300
40	57,700	66,200	69,500	69,500	51,300	69,400	69,400	69,400	51,900	50,700	69,300
45	54,700	62,300	65,800	66,100	46,300	68,600	69,400	69,400	47,400	46,300	69,300
50		59,000	62,200	62,400	42,600	66,000	69,400	69,400	43,900	42,600	69,300
55		55,900	59,100	59,300	39,000	62,300	66,600	67,900	40,600	38,900	64,700
60		53,000	57,000	57,100	35,900	58,000	63,000	61,000	37,700	35,800	60,200
65					33,200	54,200	57,000	55,000	35,100	33,000	56,200
70					30,900	51,000	51,900	50,000	32,900	30,600	52,700
75					28,900	48,200	47,500	45,600	30,900	28,500	48,800
80									29,100	26,600	44,800
85									27,600	25,000	40,900
90									26,200	23,500	37,500
Unpinned		69,500	69,500	69,500	55,600	69,400	69,400	69,400	69,400	56,000	69,300
Min Angle	0.0	0.0	0.0	0.0	0.0	0.0	0.0	0.0	0.0	0.0	0.0
Max Rad.	46.4	61.0	61.5	61.9	75.6	76.1	77.0	78.0	90.7	91.2	91.7
Capacity	30,500	14,600	25,100	24,400	7,900	12,500	20,600	19,300	6,800	10,700	10,400

1083010



PORTLAND OFFICE: 503.283.3111
 SEATTLE OFFICE: 206.784.1054
WWW.NESSCAMPBELL.COM

Rated Lifting Capacities in Pounds

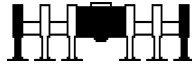

Full

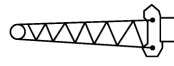

12ft Offset Fly
2° - 45°



115,500 lbs



360°

Radius (ft)	Boom Length (ft)											
	Extend Mode											
	91.0	92.5	103.8	104.2	105.7	107.6	119.4	120.3	120.3	122.2	124.1	134.9
	EM6	EM7	EM1, EM3	EM4	EM5	EM6	EM3	EM4	EM2	EM5	EM6	EM1
10	69,300	69,300										
12	69,300	69,300										
15	69,300	69,300	62,700	69,300	69,300	69,200	54,600	69,200	61,000	69,200	69,100	
20	69,300	69,300	62,700	69,300	69,300	69,200	54,600	69,200	61,000	69,200	69,100	42,600
25	69,300	69,300	61,800	69,300	69,300	69,200	54,600	69,200	61,000	69,200	69,100	42,600
30	69,300	69,300	55,000	68,300	69,300	69,200	54,600	69,200	58,300	69,200	69,100	42,600
35	69,300	69,300	49,400	62,100	69,300	69,200	52,600	66,100	52,500	69,200	69,100	42,600
40	69,300	69,300	45,000	56,700	69,300	69,200	48,000	60,800	47,700	69,200	69,100	42,600
45	69,300	69,300	41,100	52,100	69,300	69,200	44,300	56,200	43,700	69,200	69,100	41,000
50	69,300	69,300	37,700	48,200	69,300	69,200	40,900	52,200	40,100	69,200	63,500	37,700
55	69,200	66,500	34,800	45,000	67,100	67,600	37,900	48,700	37,000	68,900	58,000	34,800
60	62,200	59,400	32,200	42,000	62,400	60,500	35,300	45,700	34,300	61,800	53,200	32,200
65	56,100	53,400	30,000	39,300	57,400	54,500	33,000	43,100	31,900	55,800	49,000	29,900
70	51,100	48,400	27,900	37,000	52,200	49,500	31,000	40,600	29,700	50,800	45,200	27,900
75	46,600	43,900	25,900	34,800	47,900	45,000	29,100	38,400	27,800	46,300	42,000	26,000
80	42,600	39,700	24,200	32,900	43,800	40,900	27,400	36,400	26,000	42,200	39,000	24,400
85	38,600	35,800	22,600	31,200	39,800	36,900	25,700	34,600	24,500	38,200	35,700	22,900
90	35,200	32,600	21,500	29,700	36,400	33,600	24,200	33,000	23,100	34,800	32,400	21,700
95			20,100	28,300	33,500	30,600	22,800	31,500	21,800	31,900	29,400	20,400
100			18,900	27,100	30,800	28,000	21,800	30,200	20,600	29,200	26,800	19,300
105			17,900	26,100	28,500	25,600	20,600	28,900	19,500	26,800	24,400	18,200
110							19,500	27,200	18,500	24,700	22,300	17,300
115							18,600	25,300	17,500	22,800	20,400	16,400
120							17,700	23,600	16,700	21,100	18,700	15,500
125											17,200	14,700
130												14,000
135												13,400
Unpinned	69,300	60,200	60,700	69,300	69,300	61,400	54,600	69,200	60,700	61,800	44,600	42,600
Min Angle	0.0	0.0	0.0	0.0	0.0	0.0	0.0	0.0	0.0	0.0	0.0	0.0
Max Rad.	93.1	94.5	105.8	106.3	107.7	109.7	121.4	122.4	122.4	124.3	126.2	137.0
Capacity	16,000	14,000	5,900	5,600	8,100	11,600	4,800	4,200	7,200	5,700	8,000	3,800

1083010



PORTLAND OFFICE: 503.283.3111
SEATTLE OFFICE: 206.784.1054
WWW.NESSCAMPBELL.COM

Rated Lifting Capacities in Pounds

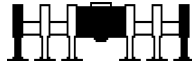

Full

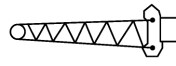

12ft Offset Fly
2° - 45°



115,500 lbs



360°

Boom Length (ft)											
Extend Mode											
Radius (ft)	135.4	136.8	152.0	152.4	153.4	167.1	168.5	169.0	183.6	185.5	200.1
	EM3	EM4	EM3	EM2	EM4	EM1	EM3	EM2	EM1	EM2	EM1
25	55,600	69,100	55,000	49,300	59,000	35,100	43,000	42,100			
30	55,600	69,100	55,000	49,100	59,000	35,100	43,000	42,100	32,900	35,400	
35	55,600	68,900	55,000	49,100	59,000	35,100	43,000	42,100	32,900	35,400	28,100
40	51,100	63,800	53,400	47,200	59,000	35,100	43,000	42,100	32,900	35,400	28,100
45	47,200	59,300	49,600	43,200	59,000	35,100	43,000	42,100	32,900	35,400	28,100
50	43,900	55,400	46,300	39,700	56,500	35,100	43,000	41,800	32,900	35,400	28,100
55	40,900	52,000	43,300	36,600	52,000	35,100	43,000	38,800	32,900	35,400	28,100
60	38,200	48,900	40,700	33,900	48,100	32,800	42,100	36,100	32,900	35,400	28,100
65	35,900	46,100	38,300	31,400	44,800	30,400	39,800	33,700	32,500	35,200	28,100
70	33,800	43,700	36,200	29,300	41,700	28,300	37,800	31,500	30,400	33,100	28,100
75	31,900	41,400	34,300	27,300	38,800	26,400	35,900	29,500	28,500	31,100	28,100
80	30,200	39,400	32,500	25,500	36,200	24,700	34,200	27,700	26,700	29,400	28,100
85	28,600	37,600	30,900	23,900	33,900	23,100	32,500	26,000	25,100	27,700	26,800
90	27,100	35,700	29,400	22,400	31,800	21,800	30,500	24,500	23,700	26,200	25,300
95	25,700	32,900	28,100	21,000	29,800	20,500	28,700	23,100	22,300	24,800	23,900
100	24,300	30,200	26,800	19,800	28,000	19,300	27,000	21,700	21,100	23,500	22,700
105	23,100	27,800	25,600	18,600	26,400	18,100	25,400	20,600	19,900	22,000	21,400
110	22,100	25,600	24,400	17,600	24,400	17,100	24,000	19,500	18,900	21,000	20,400
115	21,000	23,700	23,300	16,600	22,500	16,100	22,700	18,500	17,900	20,000	19,400
120	20,100	22,000	22,300	15,600	20,800	15,200	21,200	17,500	17,000	19,000	18,400
125	19,200	20,400	20,800	14,800	19,200	14,400	19,600	16,600	16,100	17,900	17,500
130	18,400	19,000	19,300	14,000	17,700	13,600	18,200	15,800	15,300	16,900	16,700
135	17,600	17,700	18,000	13,200	16,500	12,900	17,000	15,000	14,500	16,000	15,900
140			16,900	12,500	15,300	12,200	15,800	14,300	13,800	14,800	15,200
145			15,800	11,900	14,200	11,500	14,700	13,600	13,100	13,700	14,400
150				11,300	13,200	10,900	13,600	13,000	12,500	12,600	13,300
155						10,300	12,600	12,400	11,900	11,700	12,300
160						9,800	11,700	11,700	11,300	10,700	11,400
165							10,900	10,800	10,800	9,900	10,600
170								10,100	10,300	9,100	9,800
175									9,800	8,400	9,000
180									9,200	7,700	8,300
185											7,700
190											7,100
195											6,500
Unpinned	55,600	63,400	55,000	49,300	59,000	35,100	43,000	42,100	32,900	35,400	28,100
Min Angle	0.0	0.0	19.0	0.0	10.5	18.0	11.0	0.0	12.0	15.0	14.5
Max Rad.	137.5	138.9	150.0	154.5	155.0	165.0	170.0	171.0	185.0	185.0	200.0
Capacity	3,500	2,600	0	3,900	0	0	0	2,200	0	0	0

1083010



PORTLAND OFFICE: 503.283.3111
 SEATTLE OFFICE: 206.784.1054
 WWW.NESSCAMPBELL.COM

Rated Lifting Capacities in Pounds

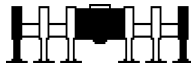

Full

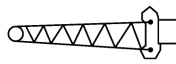

40ft Offset Fly

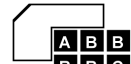

115,500 lbs



Radius (ft)	Boom Length (ft)											
	Fly Offset											
	44.3				73.5				103.8			
	2°	15°	30°	45°	2°	15°	30°	45°	2°	15°	30°	45°
10	34,700											
12	34,700				34,600							
15	34,700	34,700			34,600							
20	34,700	32,000			34,600	34,600			34,500			
25	33,900	28,800	24,900		34,600	32,900			34,500			
30	30,200	26,200	22,900	20,200	34,600	30,300	25,100		34,500	33,500		
35	27,200	24,000	20,700	19,000	34,500	28,100	23,600	20,300	34,500	31,400	25,200	
40	24,800	21,400	19,400	18,000	31,600	26,200	21,700	19,500	34,500	29,500	24,000	20,400
45	21,900	19,900	18,200	17,200	29,100	24,600	20,700	18,700	34,500	27,800	23,000	19,700
50	20,200	18,600	17,300	16,400	27,000	23,100	19,700	18,000	32,500	26,300	21,500	19,100
55	18,800	17,500	16,400	15,800	25,100	21,200	18,900	17,400	30,400	25,000	20,700	18,500
60	17,500	16,500	15,700	15,300	23,500	20,100	18,100	16,900	28,600	23,800	20,000	18,000
65	16,400	15,600	15,000	14,900	21,400	19,200	17,400	16,400	26,700	22,700	19,300	17,500
70	15,400	14,900	14,600		20,200	18,300	16,800	15,900	24,800	21,200	18,600	17,100
75	14,500	14,300			19,200	17,500	16,200	15,600	23,200	20,400	18,000	16,700
80					18,200	16,800	15,700	15,300	22,000	19,600	17,500	16,400
85					17,300	16,100	15,300	15,000	20,600	18,800	17,000	16,000
90					16,500	15,500	14,900		19,400	18,200	16,600	15,700
95					15,700	15,000	14,600		18,100	17,600	16,200	15,500
100					15,100	14,600			17,000	17,000	15,800	15,300
105					9,500				16,000	16,000	15,400	15,100
110									15,100	15,100	15,100	14,900
115									14,300	14,300	14,300	
120									13,500	13,500	13,500	
125									12,800	12,800	12,800	
130									12,200	12,200		
135									8,800			
Min Angle	0.0	0.0	0.0	0.0	0.0	0.0	0.0	0.0	0.0	0.0	0.0	0.0
Max Rad.	75.9	75.8	74.5	71.9	105.1	104.9	103.2	100.0	135.3	135.1	133.1	129.6
Capacity	11,200	11,400	12,100	13,600	3,700	3,700	3,900	4,200	2,600	2,600	2,700	2,900

1081040



PORTLAND OFFICE: 503.283.3111
 SEATTLE OFFICE: 206.784.1054
WWW.NESSCAMPBELL.COM

Rated Lifting Capacities in Pounds

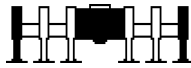

Full

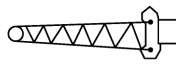

40ft Offset Fly



115,500 lbs



Radius (ft)	Boom Length (ft)											
	Fly Offset											
	134.9				167.1				183.6			
	2°	15°	30°	45°	2°	15°	30°	45°	2°	15°	30°	45°
25	29,700											
30	29,700				19,800							
35	29,700	29,500			19,800				18,600			
40	29,700	29,500			19,800	19,700			18,600			
45	29,700	29,500	24,300		19,800	19,700			18,600	18,500		
50	29,700	29,000	23,400	19,900	19,800	19,700	19,600		18,600	18,500		
55	29,700	27,700	22,100	19,300	19,800	19,700	19,600		18,600	18,500	18,300	
60	29,700	26,400	21,400	18,900	19,800	19,700	19,600	19,300	18,600	18,500	18,300	18,000
65	27,800	25,300	20,700	18,400	19,800	19,700	19,600	19,100	18,600	18,500	18,300	18,000
70	25,800	24,300	20,100	18,000	19,800	19,700	19,600	18,700	18,600	18,500	18,300	18,000
75	24,100	23,400	19,600	17,600	19,800	19,700	19,600	18,400	18,600	18,500	18,300	18,000
80	22,500	22,000	19,000	17,300	19,800	19,700	19,600	18,000	18,600	18,500	18,300	18,000
85	21,300	21,200	18,500	17,000	19,800	19,700	19,600	17,700	18,600	18,500	18,300	18,000
90	20,000	19,900	18,000	16,600	19,800	19,700	19,300	17,400	18,600	18,500	18,300	17,700
95	18,800	18,800	17,600	16,400	19,300	19,400	18,900	17,100	18,600	18,500	18,300	17,500
100	17,700	17,700	17,200	16,100	18,200	18,300	18,300	16,900	18,600	18,500	18,300	17,200
105	16,700	16,700	16,700	15,800	17,100	17,200	17,300	16,600	18,500	18,500	18,300	16,900
110	15,800	15,800	15,800	15,600	16,100	16,200	16,300	16,400	17,500	17,500	17,500	16,700
115	15,000	15,000	15,000	15,000	15,200	15,300	15,400	15,500	16,600	16,600	16,600	16,500
120	14,200	14,200	14,200	14,200	14,300	14,500	14,600	14,700	15,700	15,700	15,800	15,800
125	13,500	13,500	13,500	13,500	13,500	13,700	13,800	13,900	14,900	14,900	15,000	15,000
130	12,800	12,800	12,800	12,900	12,800	12,900	13,100	13,100	14,100	14,200	14,200	14,300
135	12,100	12,200	12,200	12,200	12,100	12,200	12,400	12,400	13,400	13,500	13,500	13,600
140	11,500	11,600	11,600		11,400	11,600	11,700	11,800	12,700	12,800	12,900	12,900
145	11,000	11,000	11,100		10,800	10,900	11,100	11,100	12,100	12,200	12,200	12,300
150	10,500	10,500	10,500		10,200	10,400	10,500	10,500	11,500	11,600	11,600	11,700
155	10,000	10,000	10,000		9,700	9,800	9,900	10,000	10,900	11,000	11,100	11,100
160	9,500	9,600			9,200	9,300	9,400	9,400	10,400	10,400	10,500	10,600
165					8,700	8,800	8,900	8,900	9,800	9,900	10,000	10,000
170					8,200	8,300	8,400		9,400	9,400	9,500	9,500
175					7,800	7,900	7,900		8,900	9,000	9,100	9,100
180					7,400	7,500	7,500		8,500	8,500	8,600	8,600
185					7,000	7,100	7,100		8,100	8,100	8,200	
190					6,600	6,700			7,700	7,700	7,800	
195									7,300	7,400	7,400	
200									7,000	7,000	7,000	
205									6,600	6,700		
210									6,300			
Min Angle	13.5	15.0	23.5	4.0	17.5	19.0	16.5	21.0	10.0	21.5	20.0	23.5
Max Rad.	165.0	165.0	160.0	158.4	195.0	195.0	195.0	190.0	213.8	210.0	210.0	205.0
Capacity	0	0	0	0	0	0	0	0	0	0	0	0

1081040



PORTLAND OFFICE: 503.283.3111
 SEATTLE OFFICE: 206.784.1054
WWW.NESSCAMPBELL.COM

Rated Lifting Capacities in Pounds

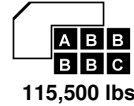
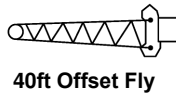
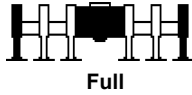

Radius (ft)	Boom Length (ft)			
	Fly Offset			
	200.1			
	2°	15°	30°	45°
40	16,100			
45	16,100			
50	16,100	16,100		
55	16,100	16,100		
60	16,100	16,100	15,900	
65	16,100	16,100	15,900	15,600
70	16,100	16,100	15,900	15,600
75	16,100	16,100	15,900	15,600
80	16,100	16,100	15,900	15,600
85	16,100	16,100	15,900	15,600
90	16,100	16,100	15,900	15,600
95	16,100	16,100	15,900	15,600
100	16,100	16,100	15,900	15,600
105	16,100	16,100	15,900	15,600
110	16,100	16,100	15,900	15,600
115	16,100	16,100	15,900	15,600
120	16,100	16,100	15,900	15,600
125	16,000	16,000	15,900	15,600
130	15,300	15,300	15,200	15,200
135	14,500	14,500	14,500	14,500
140	13,800	13,800	13,900	13,900
145	13,200	13,200	13,200	13,200
150	12,600	12,600	12,600	12,600
155	12,000	12,000	12,100	12,100
160	11,400	11,500	11,500	11,500
165	10,900	11,000	11,000	11,000
170	10,400	10,500	10,500	10,500
175	9,700	10,000	10,000	10,100
180	9,000	9,300	9,600	9,600
185	8,300	8,600	8,900	9,000
190	7,700	8,000	8,200	8,300
195	7,100	7,400	7,600	7,600
200	6,500	6,800	6,900	
205	6,000	6,200	6,400	
210	5,500	5,700	5,800	
215	5,000	5,200	5,300	
220	4,600	4,700		
225	4,200	4,300		
Min Angle	14.5	15.5	22.0	25.0
Max Rad.	230.0	230.0	225.0	220.0
Capacity	0	0	0	0

1081040



PORTLAND OFFICE: 503.283.3111
 SEATTLE OFFICE: 206.784.1054
WWW.NESSCAMPBELL.COM

Rated Lifting Capacities in Pounds

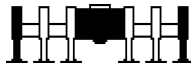

Full

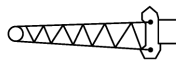

40ft Offset Fly

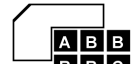

115,500 lbs



Radius (ft)	Boom Length (ft)											
	Fly Offset											
	44.3				58.9				89.1			
	2°	15°	30°	45°	2°	15°	30°	45°	2°	15°	30°	45°
10	34,700				34,700							
12	34,700				34,700							
15	34,700	34,700			34,700				34,600			
20	34,700	32,000			34,700	34,200			34,600			
25	33,900	28,800	24,900		34,700	31,100	25,900		34,600	34,600		
30	30,200	26,200	22,900	20,200	34,200	28,400	24,100		34,600	32,100	25,900	
35	27,200	24,000	20,700	19,000	31,000	26,200	21,900	19,800	34,600	29,900	24,500	
40	24,800	21,400	19,400	18,000	28,300	24,300	20,700	18,800	34,600	28,000	23,300	20,000
45	21,900	19,900	18,200	17,200	26,000	22,000	19,600	18,000	32,200	26,300	21,700	19,300
50	20,200	18,600	17,300	16,400	24,000	20,600	18,600	17,300	29,900	24,900	20,700	18,600
55	18,800	17,500	16,400	15,800	21,600	19,500	17,800	16,700	27,900	23,600	19,900	18,000
60	17,500	16,500	15,700	15,300	20,200	18,400	17,000	16,100	26,200	21,800	19,100	17,500
65	16,400	15,600	15,000	14,900	19,000	17,500	16,300	15,700	24,600	20,800	18,400	17,000
70	15,400	14,900	14,600		17,900	16,700	15,700	15,300	23,300	19,900	17,800	16,600
75	14,500	14,300			16,900	15,900	15,200	15,000	21,400	19,000	17,200	16,200
80					16,000	15,300	14,800		20,400	18,300	16,700	15,800
85					15,200	14,700	14,500		19,400	17,600	16,200	15,500
90					14,500				18,500	16,900	15,800	15,300
95									17,700	16,400	15,400	15,100
100									17,000	15,800	15,100	14,900
105									16,300	15,300	14,800	
110									15,700	14,900	14,600	
115									15,100	14,600		
120									14,500			
Min Angle	0.0	0.0	0.0	0.0	0.0	0.0	0.0	0.0	0.0	0.0	0.0	0.0
Max Rad. Capacity	75.9	75.8	74.5	71.9	90.5	90.4	88.8	85.9	120.7	120.5	118.6	115.2
Capacity	11,200	11,400	12,100	13,600	6,600	6,700	7,000	7,700	4,900	5,000	5,200	5,700

1081050



PORTLAND OFFICE: 503.283.3111
 SEATTLE OFFICE: 206.784.1054
WWW.NESSCAMPBELL.COM

Rated Lifting Capacities in Pounds

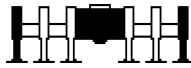

Full

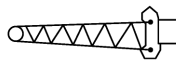

40ft Offset Fly



115,500 lbs



Radius (ft)	Boom Length (ft)											
	Fly Offset											
	120.3				152.4				169.0			
	2°	15°	30°	45°	2°	15°	30°	45°	2°	15°	30°	45°
25	34,500											
30	34,500				31,300							
35	34,500	32,800			31,300							
40	34,500	30,900			31,300				29,200			
45	34,500	29,300	23,700		31,300	31,200			29,200			
50	34,500	27,800	22,800	19,500	31,300	30,300	24,000		29,200	29,100		
55	33,100	26,500	21,500	19,000	31,300	28,900	23,200		29,200	29,100	23,800	
60	31,200	25,300	20,800	18,500	31,300	27,700	22,000	19,300	29,200	28,800	23,100	
65	29,300	24,200	20,100	18,000	29,700	26,600	21,400	18,800	29,200	27,700	22,000	19,200
70	27,300	23,200	19,500	17,600	27,600	25,600	20,800	18,400	29,200	26,700	21,400	18,800
75	25,500	21,700	18,900	17,200	25,700	24,600	20,200	18,100	27,500	25,700	20,800	18,400
80	23,800	20,900	18,300	16,900	24,000	23,700	19,700	17,700	25,800	24,800	20,300	18,100
85	22,500	20,200	17,900	16,500	22,500	22,500	19,200	17,400	24,200	24,000	19,800	17,800
90	21,100	19,500	17,400	16,200	21,100	21,200	18,800	17,100	22,800	22,600	19,400	17,400
95	19,900	18,800	17,000	16,000	19,800	19,900	18,300	16,800	21,400	21,300	18,900	17,200
100	18,800	18,200	16,600	15,700	18,700	18,700	17,900	16,500	20,200	20,100	18,500	16,900
105	17,800	17,700	16,200	15,500	17,600	17,700	17,500	16,300	19,100	19,000	18,100	16,600
110	16,800	16,800	15,800	15,300	16,600	16,700	16,800	16,000	18,000	18,000	17,800	16,400
115	15,900	15,900	15,600	15,100	15,600	15,700	15,800	15,800	17,100	17,100	17,100	16,200
120	15,100	15,100	15,100	15,000	14,800	14,900	15,000	15,100	16,200	16,200	16,200	16,000
125	14,400	14,400	14,400	14,400	13,900	14,100	14,200	14,200	15,400	15,400	15,400	15,500
130	13,700	13,700	13,700		13,200	13,300	13,400	13,500	14,600	14,600	14,700	14,700
135	13,000	13,000	13,000		12,500	12,600	12,700	12,800	13,900	13,900	14,000	14,000
140	12,400	12,400	12,400		11,800	11,900	12,000	12,100	13,200	13,200	13,300	13,300
145	11,800	11,800			11,200	11,300	11,400	11,400	12,500	12,600	12,600	12,700
150	11,300	11,300			10,600	10,700	10,800	10,800	11,900	12,000	12,000	12,100
155					10,000	10,100	10,200		11,300	11,400	11,500	11,500
160					9,500	9,600	9,700		10,800	10,900	10,900	10,900
165					9,000	9,100	9,200		10,300	10,300	10,400	10,400
170					8,600	8,600	8,700		9,800	9,800	9,900	
175					8,100	8,200			9,300	9,400	9,400	
180									8,900	8,900	9,000	
185									8,500	8,500	8,500	
190									8,100	8,100		
195									7,700	7,800		
Min Angle	0.0	0.0	0.0	0.0	17.5	19.5	17.5	22.5	9.5	7.0	20.5	24.5
Max Rad.	151.9	151.6	149.6	145.9	180.0	180.0	180.0	175.0	200.0	199.9	195.0	190.0
Capacity	3,200	3,200	3,400	3,700	0	0	0	0	0	0	0	0

1081050



PORTLAND OFFICE: 503.283.3111
 SEATTLE OFFICE: 206.784.1054
WWW.NESSCAMPBELL.COM

Rated Lifting Capacities in Pounds

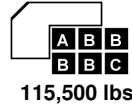
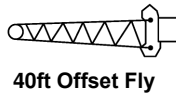
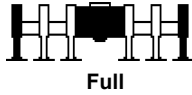

Radius (ft)	Boom Length (ft)			
	Fly Offset			
	185.5			
	2°	15°	30°	45°
40	20,200			
45	20,200			
50	20,200	20,100		
55	20,200	20,100		
60	20,200	20,100	19,900	
65	20,200	20,100	19,900	
70	20,200	20,100	19,900	19,100
75	20,200	20,100	19,900	18,700
80	20,200	20,100	19,900	18,400
85	20,200	20,100	19,900	18,100
90	20,200	20,100	19,900	17,800
95	20,200	20,100	19,500	17,500
100	20,200	20,100	19,100	17,200
105	20,200	20,100	18,700	17,000
110	19,200	19,100	18,300	16,700
115	18,300	18,200	18,000	16,500
120	17,400	17,300	17,200	16,300
125	16,500	16,500	16,400	16,100
130	15,800	15,700	15,700	15,700
135	15,000	15,000	15,000	15,000
140	14,300	14,300	14,300	14,300
145	13,700	13,700	13,700	13,700
150	13,000	13,100	13,100	13,100
155	12,500	12,500	12,500	12,500
160	11,700	11,900	11,900	12,000
165	10,800	11,200	11,400	11,400
170	10,000	10,400	10,700	10,800
175	9,300	9,600	9,900	10,000
180	8,600	8,900	9,100	9,200
185	7,900	8,200	8,400	
190	7,300	7,500	7,700	
195	6,700	6,900	7,000	
200	6,100	6,300	6,400	
205	5,600	5,800	5,800	
210	5,100	5,200		
Min Angle	15.0	16.0	22.5	10.0
Max Rad. Capacity	215.0	215.0	210.0	209.0
	0	0	0	0

1081050



PORTLAND OFFICE: 503.283.3111
 SEATTLE OFFICE: 206.784.1054
WWW.NESSCAMPBELL.COM

Rated Lifting Capacities in Pounds

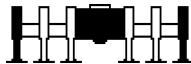

Full

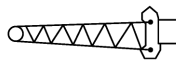

40ft Offset Fly

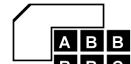

115,500 lbs



Radius (ft)	Boom Length (ft)											
	Fly Offset											
	44.3				73.5				103.8			
	2°	15°	30°	45°	2°	15°	30°	45°	2°	15°	30°	45°
10	34,700											
12	34,700				34,600							
15	34,700	34,700			34,600							
20	34,700	32,000			34,600	34,600			34,500			
25	33,900	28,800	24,900		34,600	32,900			34,500			
30	30,200	26,200	22,900	20,200	34,600	30,300	25,100		34,500	33,500		
35	27,200	24,000	20,700	19,000	34,500	28,100	23,600	20,300	34,500	31,400	25,200	
40	24,800	21,400	19,400	18,000	31,600	26,200	21,700	19,500	34,500	29,500	24,000	20,400
45	21,900	19,900	18,200	17,200	29,100	24,600	20,700	18,700	34,500	27,800	23,000	19,700
50	20,200	18,600	17,300	16,400	27,000	23,100	19,700	18,000	32,500	26,300	21,500	19,100
55	18,800	17,500	16,400	15,800	25,100	21,200	18,900	17,400	30,400	25,000	20,700	18,500
60	17,500	16,500	15,700	15,300	23,500	20,100	18,100	16,900	28,600	23,800	20,000	18,000
65	16,400	15,600	15,000	14,900	21,400	19,200	17,400	16,400	26,700	22,700	19,300	17,500
70	15,400	14,900	14,600		20,200	18,300	16,800	15,900	24,800	21,200	18,600	17,100
75	14,500	14,300			19,200	17,500	16,200	15,600	23,200	20,400	18,000	16,700
80					18,200	16,800	15,700	15,300	22,000	19,600	17,500	16,400
85					17,300	16,100	15,300	15,000	20,600	18,800	17,000	16,000
90					16,500	15,500	14,900		19,400	18,200	16,600	15,700
95					15,700	15,000	14,600		18,100	17,600	16,200	15,500
100					15,100	14,600			17,000	17,000	15,800	15,300
105					9,500				16,000	16,000	15,400	15,100
110									15,100	15,100	15,100	14,900
115									14,300	14,300	14,300	
120									13,500	13,500	13,500	
125									12,800	12,800	12,800	
130									12,200	12,200		
135									8,800			
Min Angle	0.0	0.0	0.0	0.0	0.0	0.0	0.0	0.0	0.0	0.0	0.0	0.0
Max Rad.	75.9	75.8	74.5	71.9	105.1	104.9	103.2	100.0	135.3	135.1	133.1	129.6
Capacity	11,200	11,400	12,100	13,600	3,700	3,700	3,900	4,200	2,600	2,600	2,700	2,900

1081060



PORTLAND OFFICE: 503.283.3111
 SEATTLE OFFICE: 206.784.1054
WWW.NESSCAMPBELL.COM

Rated Lifting Capacities in Pounds

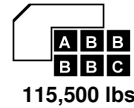
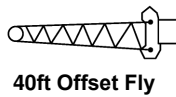
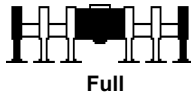

Radius (ft)	Boom Length (ft)											
	Fly Offset											
	119.4				135.4				152.0			
	2°	15°	30°	45°	2°	15°	30°	45°	2°	15°	30°	45°
25	33,900				34,400							
30	33,900				34,400				33,800			
35	33,900	32,700			34,400	33,900			33,800			
40	33,900	30,900	24,700		34,400	32,100			33,800	33,300		
45	33,900	29,200	23,700	20,100	34,400	30,500	24,300		33,800	31,700	24,900	
50	33,900	27,700	22,800	19,500	34,400	29,000	23,400	19,900	33,800	30,200	24,000	20,200
55	33,000	26,400	21,500	19,000	34,400	27,700	22,100	19,400	33,800	28,900	23,200	19,700
60	31,000	25,200	20,700	18,500	33,400	26,500	21,400	18,900	33,800	27,700	22,000	19,200
65	28,900	24,100	20,000	18,000	31,200	25,400	20,700	18,400	33,100	26,600	21,400	18,800
70	27,000	23,100	19,400	17,600	29,200	24,300	20,100	18,000	31,100	25,500	20,800	18,400
75	25,300	21,600	18,800	17,200	27,400	23,400	19,600	17,600	29,300	24,600	20,200	18,000
80	23,800	20,800	18,300	16,900	25,800	22,000	19,000	17,300	27,700	23,700	19,700	17,700
85	22,500	20,100	17,800	16,500	24,400	21,300	18,500	17,000	26,200	22,900	19,200	17,400
90	21,300	19,400	17,300	16,200	23,100	20,600	18,100	16,700	24,800	21,700	18,700	17,100
95	20,100	18,800	16,900	15,900	21,900	19,900	17,600	16,400	23,600	21,000	18,300	16,800
100	19,100	18,200	16,500	15,700	20,800	19,300	17,200	16,100	22,400	20,400	17,900	16,500
105	18,000	17,600	16,100	15,500	19,800	18,700	16,800	15,900	21,400	19,800	17,500	16,300
110	17,000	16,800	15,800	15,300	18,900	18,200	16,500	15,600	20,400	19,200	17,100	16,000
115	16,100	16,000	15,500	15,100	17,900	17,600	16,200	15,500	19,500	18,700	16,800	15,800
120	15,300	15,200	15,100	15,000	17,100	16,800	15,800	15,300	18,700	18,200	16,500	15,600
125	14,500	14,400	14,400	14,400	16,200	16,000	15,600	15,100	17,900	17,500	16,200	15,500
130	13,800	13,800	13,700		15,500	15,300	15,200	15,000	17,100	16,700	15,900	15,300
135	13,200	13,100	13,100		14,800	14,600	14,500	14,500	16,300	16,000	15,600	15,200
140	12,600	12,500	12,500		14,100	14,000	13,900		15,600	15,400	15,200	15,000
145	12,000	12,000			13,500	13,400	13,400		15,000	14,800	14,600	14,500
150					13,000	12,900	12,800		14,400	14,200	14,100	14,000
155					12,400	12,400	12,400		13,800	13,700	13,600	
160					12,000	11,900			13,300	13,200	13,100	
165									12,800	12,700	12,600	
170									12,200	12,300	12,200	
175									11,400	11,600		
Min Angle	11.5	13.0	0.0	0.0	14.5	16.0	24.0	3.5	17.0	18.5	16.5	21.5
Max Rad.	150.0	150.0	148.6	144.9	165.0	165.0	160.0	158.9	180.0	180.0	180.0	175.0
Capacity	0	0	2,000	2,200	0	0	0	0	0	0	0	0

1081060



PORTLAND OFFICE: 503.283.3111
 SEATTLE OFFICE: 206.784.1054
WWW.NESSCAMPBELL.COM

Rated Lifting Capacities in Pounds

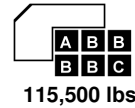
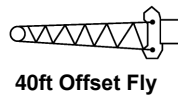
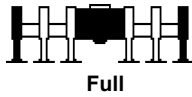

Radius (ft)	Boom Length (ft)			
	Fly Offset			
	168.5			
	2°	15°	30°	45°
35	29,200			
40	29,200			
45	29,200	29,000		
50	29,200	29,000		
55	29,200	29,000	23,800	
60	29,200	28,800	23,100	19,600
65	29,200	27,700	22,000	19,200
70	29,200	26,600	21,400	18,800
75	29,200	25,700	20,800	18,400
80	29,100	24,800	20,300	18,100
85	27,600	24,000	19,800	17,700
90	26,200	23,200	19,300	17,400
95	25,000	22,000	18,900	17,100
100	23,800	21,400	18,500	16,900
105	22,700	20,800	18,100	16,600
110	21,600	20,200	17,700	16,400
115	20,700	19,700	17,400	16,200
120	19,900	19,200	17,100	16,000
125	19,100	18,500	16,800	15,800
130	18,400	17,800	16,500	15,600
135	17,700	17,200	16,200	15,400
140	16,900	16,600	15,900	15,300
145	15,700	15,900	15,600	15,200
150	14,600	15,100	15,100	15,000
155	13,600	14,000	14,400	14,500
160	12,700	13,100	13,400	13,500
165	11,800	12,200	12,400	12,500
170	11,000	11,300	11,500	
175	10,300	10,500	10,700	
180	9,600	9,800	9,900	
185	8,900	9,100	9,200	
190	8,300	8,400		
195	7,700			
Min Angle	8.5	20.5	19.5	23.5
Max Rad.	198.8	195.0	195.0	190.0
Capacity	0	0	0	0

1081060



PORTLAND OFFICE: 503.283.3111
 SEATTLE OFFICE: 206.784.1054
WWW.NESSCAMPBELL.COM

Rated Lifting Capacities in Pounds

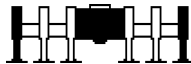

Full

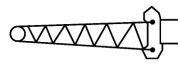

40ft Hydraulic Offset Fly

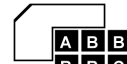

115,500 lbs



Radius (ft)	Boom Length (ft)											
	Fly Offset											
	44.3			73.5			103.8			134.9		
	2°-15°	15°-30°	30°-45°	2°-15°	15°-30°	30°-45°	2°-15°	15°-30°	30°-45°	2°-15°	15°-30°	30°-45°
10	34,700											
12	34,700	34,700		34,600								
15	34,700	34,700		34,600								
20	32,000	27,100	27,100	34,600	34,600		34,500					
25	28,800	24,900	24,900	32,900	32,900		34,500	34,500		29,700		
30	26,200	22,900	20,200	30,300	25,100	25,100	33,500	33,500		29,700		
35	24,000	20,700	19,000	28,100	23,600	20,300	31,400	25,200	25,200	29,500	29,500	
40	21,400	19,400	18,000	26,200	21,700	19,500	29,500	24,000	20,400	29,500	25,300	25,300
45	19,900	18,200	17,200	24,600	20,700	18,700	27,800	23,000	19,700	29,500	24,300	20,400
50	18,600	17,300	16,400	23,100	19,700	18,000	26,300	21,500	19,100	29,000	23,400	19,900
55	17,500	16,400	15,800	21,200	18,900	17,400	25,000	20,700	18,500	27,700	22,100	19,300
60	16,500	15,700	15,300	20,100	18,100	16,900	23,800	20,000	18,000	26,400	21,400	18,900
65	15,600	15,000	14,900	19,200	17,400	16,400	22,700	19,300	17,500	25,300	20,700	18,400
70	14,900	14,600	14,600	18,300	16,800	15,900	21,200	18,600	17,100	24,300	20,100	18,000
75	14,300	14,300		17,500	16,200	15,600	20,400	18,000	16,700	23,400	19,600	17,600
80				16,800	15,700	15,300	19,600	17,500	16,400	22,000	19,000	17,300
85				16,100	15,300	15,000	18,800	17,000	16,000	21,200	18,500	17,000
90				15,500	14,900	14,900	18,200	16,600	15,700	19,900	18,000	16,600
95				15,000	14,600	14,600	17,600	16,200	15,500	18,800	17,600	16,400
100				14,600	14,500		17,000	15,800	15,300	17,700	17,200	16,100
105				9,500			16,000	15,400	15,100	16,700	16,700	15,800
110							15,100	15,100	14,900	15,800	15,800	15,600
115							14,300	14,300	14,300	15,000	15,000	15,000
120							13,500	13,500	13,500	14,200	14,200	14,200
125							12,800	12,800	12,800	13,500	13,500	13,500
130							12,200	12,200		12,800	12,800	12,800
135							8,800			12,100	12,200	12,200
140										11,500	11,600	11,600
145										11,000	11,000	11,100
150										10,500	10,500	10,500
155										10,000	10,000	10,000
160										9,500		
Min Angle	0.0	0.0	0.0	0.0	0.0	0.0	0.0	0.0	0.0	13.5	23.5	4.0
Max Rad.	75.9	75.8	74.5	105.1	104.9	103.2	135.3	135.1	133.1	165.0	160.0	158.4
Capacity	11,200	11,400	12,100	3,700	3,700	3,900	2,600	2,600	2,700	0	0	0

1082040



PORTLAND OFFICE: 503.283.3111
 SEATTLE OFFICE: 206.784.1054
WWW.NESSCAMPBELL.COM

Rated Lifting Capacities in Pounds

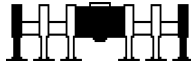

Full

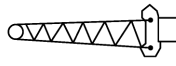

40ft Hydraulic Offset Fly

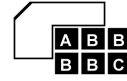

115,500 lbs



Radius (ft)	Boom Length (ft)								
	Fly Offset								
	167.1			183.6			200.1		
	2°-15°	15°-30°	30°-45°	2°-15°	15°-30°	30°-45°	2°-15°	15°-30°	30°-45°
30	19,800								
35	19,800			18,600					
40	19,700	19,700		18,400	18,400		16,100		
45	19,700	19,500	19,500	18,400	18,400		16,000	16,000	
50	19,700	19,500	19,500	18,400	18,400		16,000	16,000	
55	19,700	19,500	19,200	18,400	18,300	18,300	16,000	15,800	15,800
60	19,700	19,500	19,200	18,400	18,300	18,000	16,000	15,800	15,600
65	19,700	19,500	19,100	18,400	18,300	18,000	16,000	15,800	15,600
70	19,700	19,500	18,700	18,400	18,300	18,000	16,000	15,800	15,600
75	19,700	19,500	18,400	18,400	18,300	18,000	16,000	15,800	15,600
80	19,700	19,500	18,000	18,400	18,300	18,000	16,000	15,800	15,600
85	19,700	19,500	17,700	18,400	18,300	18,000	16,000	15,800	15,600
90	19,700	19,300	17,400	18,400	18,300	17,700	16,000	15,800	15,600
95	19,300	18,900	17,100	18,400	18,300	17,500	16,000	15,800	15,600
100	18,200	18,300	16,900	18,400	18,300	17,200	16,000	15,800	15,600
105	17,100	17,200	16,600	18,400	18,300	16,900	16,000	15,800	15,600
110	16,100	16,200	16,300	17,500	17,500	16,700	16,000	15,800	15,600
115	15,200	15,300	15,400	16,600	16,600	16,500	16,000	15,800	15,600
120	14,300	14,500	14,600	15,700	15,700	15,800	16,000	15,800	15,600
125	13,500	13,700	13,800	14,900	14,900	15,000	16,000	15,800	15,600
130	12,800	12,900	13,100	14,100	14,200	14,200	15,300	15,200	15,200
135	12,100	12,200	12,400	13,400	13,500	13,500	14,500	14,500	14,500
140	11,400	11,600	11,700	12,700	12,800	12,900	13,800	13,800	13,900
145	10,800	10,900	11,100	12,100	12,200	12,200	13,200	13,200	13,200
150	10,200	10,400	10,500	11,500	11,600	11,600	12,600	12,600	12,600
155	9,700	9,800	9,900	10,900	11,000	11,100	12,000	12,000	12,100
160	9,200	9,300	9,400	10,400	10,400	10,500	11,400	11,500	11,500
165	8,700	8,800	8,900	9,800	9,900	10,000	10,900	11,000	11,000
170	8,200	8,300	8,400	9,400	9,400	9,500	10,400	10,500	10,500
175	7,800	7,900	7,900	8,900	9,000	9,100	9,700	10,000	10,000
180	7,400	7,500	7,500	8,500	8,500	8,600	9,000	9,300	9,600
185	7,000	7,100	7,000	8,100	8,100	8,200	8,300	8,600	8,900
190	6,600	6,700		7,700	7,700	7,800	7,700	8,000	8,200
195				7,300	7,400	7,400	7,100	7,400	7,600
200				7,000	7,000	7,000	6,500	6,800	6,900
205				6,600	6,700		6,000	6,200	6,300
210							5,500	5,700	5,700
215							5,000	5,200	5,200
220							4,600	4,700	
225							4,200		
Min Angle	17.5	16.5	21.0	21.5	20.0	23.5	14.5	22.0	25.0
Max Rad. Capacity	195.0	195.0	190.0	210.0	210.0	205.0	230.0	225.0	220.0
	0	0	0	0	0	0	0	0	0

1082040



PORTLAND OFFICE: 503.283.3111
 SEATTLE OFFICE: 206.784.1054
WWW.NESSCAMPBELL.COM

Rated Lifting Capacities in Pounds

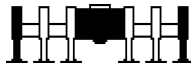

Full

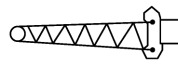

40ft Hydraulic Offset Fly

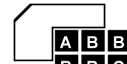

115,500 lbs



Radius (ft)	Boom Length (ft)											
	Fly Offset											
	44.3			58.9			89.1			120.3		
	2°-15°	15°-30°	30°-45°	2°-15°	15°-30°	30°-45°	2°-15°	15°-30°	30°-45°	2°-15°	15°-30°	30°-45°
10	34,700			34,700								
12	34,700	34,700		34,700								
15	34,700	34,700		34,700	34,700		34,600					
20	32,000	27,100	27,100	34,200	34,200		34,600	34,600				
25	28,800	24,900	24,900	31,100	25,900	25,900	34,600	34,600		34,500		
30	26,200	22,900	20,200	28,400	24,100	20,800	32,100	25,900	25,900	34,500	34,500	
35	24,000	20,700	19,000	26,200	21,900	19,800	29,900	24,500	20,800	32,800	25,800	25,800
40	21,400	19,400	18,000	24,300	20,700	18,800	28,000	23,300	20,000	30,900	24,700	24,700
45	19,900	18,200	17,200	22,000	19,600	18,000	26,300	21,700	19,300	29,300	23,700	20,100
50	18,600	17,300	16,400	20,600	18,600	17,300	24,900	20,700	18,600	27,800	22,800	19,500
55	17,500	16,400	15,800	19,500	17,800	16,700	23,600	19,900	18,000	26,500	21,500	19,000
60	16,500	15,700	15,300	18,400	17,000	16,100	21,800	19,100	17,500	25,300	20,800	18,500
65	15,600	15,000	14,900	17,500	16,300	15,700	20,800	18,400	17,000	24,200	20,100	18,000
70	14,900	14,600	14,600	16,700	15,700	15,300	19,900	17,800	16,600	23,200	19,500	17,600
75	14,300	14,300		15,900	15,200	15,000	19,000	17,200	16,200	21,700	18,900	17,200
80				15,300	14,800	14,800	18,300	16,700	15,800	20,900	18,300	16,900
85				14,700	14,500	14,500	17,600	16,200	15,500	20,200	17,900	16,500
90				14,300			16,900	15,800	15,300	19,500	17,400	16,200
95							16,400	15,400	15,100	18,800	17,000	16,000
100							15,800	15,100	14,900	18,200	16,600	15,700
105							15,300	14,800	14,800	17,700	16,200	15,500
110							14,900	14,600	14,600	16,800	15,800	15,300
115							14,600	14,500		15,900	15,600	15,100
120							14,400			15,100	15,100	15,000
125										14,400	14,400	14,400
130										13,700	13,700	13,700
135										13,000	13,000	13,000
140										12,400	12,400	12,400
145										11,800	11,800	
150										11,300	11,300	
Min Angle	0.0	0.0	0.0	0.0	0.0	0.0	0.0	0.0	0.0	0.0	0.0	0.0
Max Rad.	75.9	75.8	74.5	90.5	90.4	88.8	120.7	120.5	118.6	151.9	151.6	149.6
Capacity	11,200	11,400	12,100	6,600	6,700	7,000	4,900	5,000	5,200	3,200	3,200	3,400

1082050



PORTLAND OFFICE: 503.283.3111
 SEATTLE OFFICE: 206.784.1054
WWW.NESSCAMPBELL.COM

Rated Lifting Capacities in Pounds

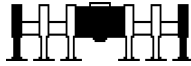

Full

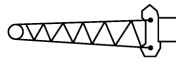

40ft Hydraulic Offset Fly

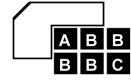

115,500 lbs



Boom Length (ft)									
Fly Offset									
Radius (ft)	152.4			169.0			185.5		
	2°-15°	15°-30°	30°-45°	2°-15°	15°-30°	30°-45°	2°-15°	15°-30°	30°-45°
30	31,300								
35	31,000	31,000							
40	31,000	31,000		29,200			20,200		
45	31,000	24,900	24,900	29,000	29,000		20,100	20,100	
50	30,300	24,000	20,200	29,000	24,500	24,500	20,100	20,100	
55	28,900	23,200	19,700	29,000	23,800	23,800	20,100	19,800	19,800
60	27,700	22,000	19,300	28,800	23,100	19,600	20,100	19,800	19,800
65	26,600	21,400	18,800	27,700	22,000	19,200	20,100	19,800	19,500
70	25,600	20,800	18,400	26,700	21,400	18,800	20,100	19,800	19,100
75	24,600	20,200	18,100	25,700	20,800	18,400	20,100	19,800	18,700
80	23,700	19,700	17,700	24,800	20,300	18,100	20,100	19,800	18,400
85	22,500	19,200	17,400	24,000	19,800	17,800	20,100	19,800	18,100
90	21,100	18,800	17,100	22,600	19,400	17,400	20,100	19,800	17,800
95	19,800	18,300	16,800	21,300	18,900	17,200	20,100	19,500	17,500
100	18,700	17,900	16,500	20,100	18,500	16,900	20,100	19,100	17,200
105	17,600	17,500	16,300	19,000	18,100	16,600	20,100	18,700	17,000
110	16,600	16,700	16,000	18,000	17,800	16,400	19,100	18,300	16,700
115	15,600	15,700	15,800	17,100	17,100	16,200	18,200	18,000	16,500
120	14,800	14,900	15,000	16,200	16,200	16,000	17,300	17,200	16,300
125	13,900	14,100	14,200	15,400	15,400	15,400	16,500	16,400	16,100
130	13,200	13,300	13,400	14,600	14,600	14,700	15,700	15,700	15,700
135	12,500	12,600	12,700	13,900	13,900	14,000	15,000	15,000	15,000
140	11,800	11,900	12,000	13,200	13,200	13,300	14,300	14,300	14,300
145	11,200	11,300	11,400	12,500	12,600	12,600	13,700	13,700	13,700
150	10,600	10,700	10,800	11,900	12,000	12,000	13,000	13,100	13,100
155	10,000	10,100	10,200	11,300	11,400	11,500	12,500	12,500	12,500
160	9,500	9,600	9,700	10,800	10,900	10,900	11,700	11,900	11,900
165	9,000	9,100	9,100	10,300	10,300	10,400	10,800	11,200	11,400
170	8,600	8,600	8,600	9,800	9,800	9,900	10,000	10,400	10,700
175	8,100	8,200		9,300	9,400	9,400	9,300	9,600	9,900
180				8,900	8,900	9,000	8,600	8,900	9,100
185				8,500	8,500	8,500	7,900	8,200	8,400
190				8,100	8,100		7,300	7,500	7,700
195				7,700			6,700	6,900	7,000
200							6,100	6,300	6,300
205							5,600	5,800	5,600
210							5,100		
Min Angle	17.5	17.5	22.5	7.0	20.5	24.5	15.0	22.5	10.0
Max Rad. Capacity	180.0	180.0	175.0	199.9	195.0	190.0	215.0	210.0	209.0
	0	0	0	0	0	0	0	0	0

1082050



PORTLAND OFFICE: 503.283.3111
 SEATTLE OFFICE: 206.784.1054
WWW.NESSCAMPBELL.COM

Rated Lifting Capacities in Pounds

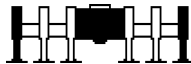

Full

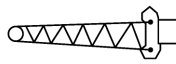

40ft Hydraulic Offset Fly

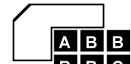

115,500 lbs



Boom Length (ft)												
Fly Offset												
Radius (ft)	44.3			73.5			103.8			119.4		
	2°-15°	15°-30°	30°-45°	2°-15°	15°-30°	30°-45°	2°-15°	15°-30°	30°-45°	2°-15°	15°-30°	30°-45°
10	34,700											
12	34,700	34,700		34,600								
15	34,700	34,700		34,600								
20	32,000	27,100	27,100	34,600	34,600		34,500					
25	28,800	24,900	24,900	32,900	32,900		34,500	34,500		33,900		
30	26,200	22,900	20,200	30,300	25,100	25,100	33,500	33,500		33,600	33,600	
35	24,000	20,700	19,000	28,100	23,600	20,300	31,400	25,200	25,200	32,700	25,800	25,800
40	21,400	19,400	18,000	26,200	21,700	19,500	29,500	24,000	20,400	30,900	24,700	20,700
45	19,900	18,200	17,200	24,600	20,700	18,700	27,800	23,000	19,700	29,200	23,700	20,100
50	18,600	17,300	16,400	23,100	19,700	18,000	26,300	21,500	19,100	27,700	22,800	19,500
55	17,500	16,400	15,800	21,200	18,900	17,400	25,000	20,700	18,500	26,400	21,500	19,000
60	16,500	15,700	15,300	20,100	18,100	16,900	23,800	20,000	18,000	25,200	20,700	18,500
65	15,600	15,000	14,900	19,200	17,400	16,400	22,700	19,300	17,500	24,100	20,000	18,000
70	14,900	14,600	14,600	18,300	16,800	15,900	21,200	18,600	17,100	23,100	19,400	17,600
75	14,300	14,300		17,500	16,200	15,600	20,400	18,000	16,700	21,600	18,800	17,200
80				16,800	15,700	15,300	19,600	17,500	16,400	20,800	18,300	16,900
85				16,100	15,300	15,000	18,800	17,000	16,000	20,100	17,800	16,500
90				15,500	14,900	14,900	18,200	16,600	15,700	19,400	17,300	16,200
95				15,000	14,600	14,600	17,600	16,200	15,500	18,800	16,900	15,900
100				14,600	14,500		17,000	15,800	15,300	18,200	16,500	15,700
105				9,500			16,000	15,400	15,100	17,600	16,100	15,500
110							15,100	15,100	14,900	16,800	15,800	15,300
115							14,300	14,300	14,300	16,000	15,500	15,100
120							13,500	13,500	13,500	15,200	15,100	15,000
125							12,800	12,800	12,800	14,400	14,400	14,400
130							12,200	12,200		13,800	13,700	13,700
135							8,800			13,100	13,100	13,100
140										12,500	12,500	12,500
145										12,000	12,000	
Min Angle	0.0	0.0	0.0	0.0	0.0	0.0	0.0	0.0	0.0	11.5	13.0	0.0
Max Rad.	75.9	75.8	74.5	105.1	104.9	103.2	135.3	135.1	133.1	150.0	150.0	148.6
Capacity	11,200	11,400	12,100	3,700	3,700	3,900	2,600	2,600	2,700	0	0	2,000

1082060



PORTLAND OFFICE: 503.283.3111
 SEATTLE OFFICE: 206.784.1054
WWW.NESSCAMPBELL.COM

Rated Lifting Capacities in Pounds

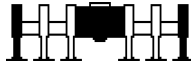

Full

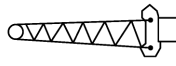

40ft Hydraulic Offset Fly

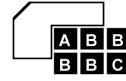

115,500 lbs



Radius (ft)	Boom Length (ft)								
	Fly Offset								
	135.4			152.0			168.5		
	2°-15°	15°-30°	30°-45°	2°-15°	15°-30°	30°-45°	2°-15°	15°-30°	30°-45°
25	34,400								
30	34,400			33,800					
35	33,900	33,900		33,500	33,500		29,200		
40	32,100	25,300	25,300	33,300	33,300		28,900	28,900	
45	30,500	24,300	20,400	31,700	24,900	24,900	28,900	28,900	
50	29,000	23,400	19,900	30,200	24,000	20,200	28,900	24,500	24,500
55	27,700	22,100	19,400	28,900	23,200	19,700	28,900	23,800	20,000
60	26,500	21,400	18,900	27,700	22,000	19,200	28,800	23,100	19,600
65	25,400	20,700	18,400	26,600	21,400	18,800	27,700	22,000	19,200
70	24,300	20,100	18,000	25,500	20,800	18,400	26,600	21,400	18,800
75	23,400	19,600	17,600	24,600	20,200	18,000	25,700	20,800	18,400
80	22,000	19,000	17,300	23,700	19,700	17,700	24,800	20,300	18,100
85	21,300	18,500	17,000	22,900	19,200	17,400	24,000	19,800	17,700
90	20,600	18,100	16,700	21,700	18,700	17,100	23,200	19,300	17,400
95	19,900	17,600	16,400	21,000	18,300	16,800	22,000	18,900	17,100
100	19,300	17,200	16,100	20,400	17,900	16,500	21,400	18,500	16,900
105	18,700	16,800	15,900	19,800	17,500	16,300	20,800	18,100	16,600
110	18,200	16,500	15,600	19,200	17,100	16,000	20,200	17,700	16,400
115	17,600	16,200	15,500	18,700	16,800	15,800	19,700	17,400	16,200
120	16,800	15,800	15,300	18,200	16,500	15,600	19,200	17,100	16,000
125	16,000	15,600	15,100	17,500	16,200	15,500	18,500	16,800	15,800
130	15,300	15,200	15,000	16,700	15,900	15,300	17,800	16,500	15,600
135	14,600	14,500	14,500	16,000	15,600	15,200	17,200	16,200	15,400
140	14,000	13,900	13,900	15,400	15,200	15,000	16,600	15,900	15,300
145	13,400	13,400	13,400	14,800	14,600	14,500	15,700	15,600	15,200
150	12,900	12,800	12,800	14,200	14,100	14,000	14,600	15,100	15,000
155	12,400	12,400	12,400	13,700	13,600	13,500	13,600	14,000	14,400
160	11,900			13,200	13,100	13,100	12,700	13,100	13,400
165				12,700	12,600	12,600	11,800	12,200	12,400
170				12,200	12,200	12,200	11,000	11,300	11,500
175				11,400	11,600		10,300	10,500	10,700
180							9,600	9,800	9,900
185							8,900	9,100	9,100
190							8,300	8,400	
Min Angle	14.5	24.0	3.5	17.0	16.5	21.5	20.5	19.5	23.5
Max Rad. Capacity	165.0	160.0	158.9	180.0	180.0	175.0	195.0	195.0	190.0
	0	0	0	0	0	0	0	0	0

1082060



PORTLAND OFFICE: 503.283.3111
 SEATTLE OFFICE: 206.784.1054
WWW.NESSCAMPBELL.COM

Rated Lifting Capacities in Pounds

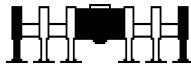

Full

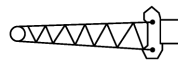

67ft Offset Fly

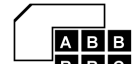

115,500 lbs



Radius (ft)	Boom Length (ft)											
	Fly Offset											
	44.3				73.5				103.8			
	2°	15°	30°	45°	2°	15°	30°	45°	2°	15°	30°	45°
15	30,000											
20	27,800				27,500							
25	24,600	19,800			27,500				18,200			
30	21,100	18,100			21,400				18,200			
35	19,100	16,600			21,400	18,500			18,200			
40	17,400	15,400	13,700		21,100	17,300			18,200	18,100		
45	16,000	14,300	12,800		19,500	16,200	13,700		18,200	17,700		
50	14,800	13,300	12,100		18,100	15,300	13,100		18,200	16,800		
55	13,800	12,500	11,400	10,600	16,900	14,400	12,400		18,200	15,900	13,200	
60	12,800	11,700	10,800	10,100	15,800	13,600	11,900	10,700	18,200	15,200	12,700	
65	12,000	11,100	10,300	9,700	14,900	12,900	11,400	10,300	17,500	14,500	12,200	10,800
70	11,200	10,500	9,800	9,300	14,000	12,300	10,900	10,000	16,600	13,800	11,800	10,500
75	10,600	9,900	9,300	8,900	13,200	11,700	10,500	9,700	15,700	13,200	11,400	10,200
80	10,000	9,400	8,900	8,600	12,500	11,200	10,100	9,400	14,900	12,700	11,000	9,900
85	9,400	9,000	8,600	8,400	11,900	10,700	9,800	9,100	14,200	12,200	10,600	9,700
90	8,900	8,600	8,300	8,200	11,300	10,300	9,400	8,900	13,500	11,700	10,300	9,400
95	8,500	8,200	8,000		10,800	9,900	9,100	8,700	12,900	11,300	10,000	9,200
100	8,100	7,900			10,300	9,500	8,900	8,500	12,400	10,900	9,700	9,000
105					9,800	9,100	8,600	8,300	11,800	10,500	9,500	8,900
110					9,400	8,800	8,400	8,200	11,400	10,200	9,200	8,700
115					9,000	8,500	8,200	8,200	10,900	9,800	9,000	8,500
120					8,700	8,300	8,000		10,500	9,500	8,800	8,400
125					8,300	8,100	8,000		10,100	9,300	8,600	8,300
130									9,800	9,000	8,400	8,200
135									9,400	8,800	8,300	8,200
140									9,100	8,500	8,200	8,200
145									8,800	8,300	8,000	
150									8,500	8,100	8,000	
155									8,300	8,000		
Min Angle	0.0	0.0	0.0	0.0	14.0	18.5	0.0	0.0	15.5	18.5	27.0	11.5
Max Rad.	102.9	102.7	100.7	96.8	130.0	130.0	128.9	123.9	160.0	160.0	155.0	146.4
Capacity	6,200	6,400	7,000	8,200	0	0	2,000	2,300	0	0	0	0

1081070



PORTLAND OFFICE: 503.283.3111
 SEATTLE OFFICE: 206.784.1054
WWW.NESSCAMPBELL.COM

Rated Lifting Capacities in Pounds

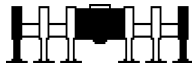

Full

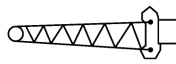

67ft Offset Fly

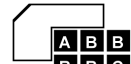

115,500 lbs



Radius (ft)	Boom Length (ft)											
	Fly Offset											
	134.9				167.1				183.6			
	2°	15°	30°	45°	2°	15°	30°	45°	2°	15°	30°	45°
30	15,900											
35	15,900				13,300							
40	15,900				13,300				12,400			
45	15,900	15,800			13,300				12,400			
50	15,900	15,800			13,300				12,400			
55	15,900	15,800			13,300	13,300			12,400			
60	15,900	15,800	13,300		13,300	13,300			12,400	12,300		
65	15,900	15,800	12,900		13,300	13,300			12,400	12,300		
70	15,900	15,100	12,400		13,300	13,300	13,000		12,400	12,300		
75	15,900	14,500	12,100	10,500	13,300	13,300	12,600		12,400	12,300	12,300	
80	15,900	14,000	11,700	10,300	13,300	13,300	12,300	10,600	12,400	12,300	12,300	
85	15,900	13,500	11,400	10,100	13,300	13,300	12,000	10,400	12,400	12,300	12,200	
90	15,700	13,000	11,100	9,800	13,300	13,300	11,600	10,200	12,400	12,300	11,900	10,300
95	15,000	12,600	10,800	9,600	13,300	13,300	11,400	10,000	12,400	12,300	11,600	10,100
100	14,400	12,100	10,500	9,500	13,300	13,300	11,100	9,800	12,400	12,300	11,400	10,000
105	13,800	11,700	10,200	9,300	13,300	12,900	10,800	9,600	12,400	12,300	11,100	9,800
110	13,300	11,400	10,000	9,100	13,300	12,500	10,600	9,500	12,400	12,300	10,900	9,600
115	12,800	11,000	9,700	9,000	13,300	12,100	10,400	9,300	12,400	12,300	10,600	9,500
120	12,300	10,700	9,500	8,800	13,300	11,800	10,100	9,200	12,400	12,300	10,400	9,300
125	11,900	10,400	9,300	8,700	13,000	11,500	9,900	9,000	12,400	12,000	10,200	9,200
130	11,400	10,100	9,100	8,600	12,300	11,200	9,700	8,900	12,400	11,600	10,000	9,100
135	11,100	9,900	8,900	8,500	11,600	10,900	9,500	8,800	12,400	11,400	9,800	9,000
140	10,700	9,600	8,800	8,400	11,000	10,600	9,400	8,700	12,000	11,100	9,600	8,900
145	10,300	9,400	8,600	8,300	10,400	10,300	9,200	8,600	11,400	10,800	9,500	8,700
150	9,800	9,100	8,500	8,200	9,800	10,000	9,000	8,500	10,800	10,600	9,300	8,600
155	9,300	8,900	8,300	8,200	9,300	9,500	8,900	8,400	10,300	10,300	9,200	8,600
160	8,900	8,700	8,200	8,100	8,800	9,000	8,800	8,300	9,800	9,900	9,000	8,500
165	8,400	8,500	8,100	8,100	8,300	8,500	8,600	8,300	9,300	9,400	8,900	8,400
170	8,000	8,100	8,000		7,800	8,100	8,300	8,200	8,800	9,000	8,800	8,300
175	7,700	7,700	7,800		7,400	7,600	7,800	7,900	8,300	8,500	8,600	8,300
180	7,300	7,400	7,400		7,000	7,200	7,400	7,500	7,900	8,100	8,300	8,200
185	7,000	7,000			6,600	6,800	7,000	7,000	7,500	7,700	7,800	7,900
190					6,300	6,400	6,600	6,600	7,200	7,300	7,500	7,500
195					5,900	6,100	6,200		6,800	6,900	7,100	7,100
200					5,600	5,700	5,800		6,400	6,600	6,700	6,800
205					5,300	5,400	5,500		6,100	6,300	6,400	6,400
210					5,000	5,100	5,200		5,800	5,900	6,000	
215					4,700	4,800			5,500	5,600	5,700	
220					4,500				5,200	5,300	5,400	
225									5,000	5,100	5,100	
230									4,700	4,800	4,800	
235									4,500	4,500		
Min Angle	17.5	20.0	27.0	14.5	10.0	22.5	13.5	14.0	16.0	17.0	22.5	22.0
Max Rad. Capacity	190.0	190.0	185.0	177.6	225.0	220.0	218.7	209.7	240.0	240.0	235.0	226.3
	0	0	0	0	0	0	0	0	0	0	0	0

1081070



PORTLAND OFFICE: 503.283.3111
 SEATTLE OFFICE: 206.784.1054
 WWW.NESSCAMPBELL.COM

Rated Lifting Capacities in Pounds

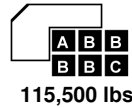
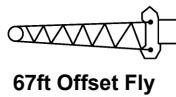
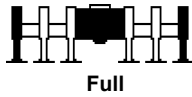

Radius (ft)	Boom Length (ft)			
	Fly Offset			
	200.1			
	2°	15°	30°	45°
45	10,800			
50	10,800			
55	10,800			
60	10,800			
65	10,800	10,800		
70	10,800	10,800		
75	10,800	10,800		
80	10,800	10,800	10,700	
85	10,800	10,800	10,700	
90	10,800	10,800	10,700	
95	10,800	10,800	10,700	10,300
100	10,800	10,800	10,700	10,100
105	10,800	10,800	10,700	9,900
110	10,800	10,800	10,700	9,800
115	10,800	10,800	10,700	9,600
120	10,800	10,800	10,700	9,500
125	10,800	10,800	10,500	9,400
130	10,800	10,800	10,300	9,200
135	10,800	10,800	10,100	9,100
140	10,800	10,800	9,900	9,000
145	10,800	10,800	9,700	8,900
150	10,800	10,800	9,600	8,800
155	10,800	10,800	9,400	8,700
160	10,600	10,500	9,300	8,600
165	10,100	10,300	9,100	8,500
170	9,700	9,800	9,000	8,400
175	9,200	9,300	8,900	8,400
180	8,800	8,900	8,700	8,300
185	8,400	8,500	8,600	8,300
190	8,000	8,100	8,200	8,200
195	7,600	7,700	7,800	7,900
200	7,100	7,400	7,500	7,500
205	6,600	7,000	7,100	7,200
210	6,100	6,500	6,800	6,800
215	5,600	6,000	6,300	6,400
220	5,100	5,500	5,800	5,800
225	4,700	5,000	5,300	
230	4,300	4,600	4,800	
235	3,900	4,100	4,300	
240	3,500	3,700	3,800	
245	3,100	3,300	3,400	
250	2,800	2,900		
Min Angle	18.0	19.5	24.5	20.5
Max Rad.	255.0	255.0	250.0	242.8
Capacity	0	0	0	0

1081070



PORTLAND OFFICE: 503.283.3111
 SEATTLE OFFICE: 206.784.1054
WWW.NESSCAMPBELL.COM

Rated Lifting Capacities in Pounds

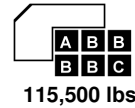
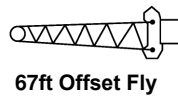
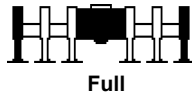

Radius (ft)	Boom Length (ft)											
	Fly Offset											
	44.3				58.9				89.1			
	2°	15°	30°	45°	2°	15°	30°	45°	2°	15°	30°	45°
15	30,000											
20	27,800				30,000				28,400			
25	24,600	19,800			26,900				28,400			
30	21,100	18,100			24,100	19,100			28,100			
35	19,100	16,600			21,100	17,700			25,600	19,300		
40	17,400	15,400	13,700		19,300	16,400			23,500	18,100		
45	16,000	14,300	12,800		17,800	15,300	13,300		21,100	17,000		
50	14,800	13,300	12,100		16,500	14,400	12,600		19,700	16,100	13,400	
55	13,800	12,500	11,400	10,600	15,400	13,500	12,000	10,900	18,400	15,200	12,900	
60	12,800	11,700	10,800	10,100	14,400	12,700	11,400	10,400	17,300	14,500	12,300	10,900
65	12,000	11,100	10,300	9,700	13,500	12,100	10,900	10,000	16,300	13,800	11,800	10,600
70	11,200	10,500	9,800	9,300	12,700	11,400	10,400	9,700	15,300	13,100	11,400	10,300
75	10,600	9,900	9,300	8,900	11,900	10,900	10,000	9,300	14,500	12,500	11,000	10,000
80	10,000	9,400	8,900	8,600	11,300	10,400	9,600	9,000	13,800	12,000	10,600	9,700
85	9,400	9,000	8,600	8,400	10,700	9,900	9,200	8,800	13,100	11,500	10,200	9,400
90	8,900	8,600	8,300	8,200	10,200	9,500	8,900	8,600	12,500	11,100	9,900	9,200
95	8,500	8,200	8,000		9,700	9,100	8,600	8,400	11,900	10,600	9,600	9,000
100	8,100	7,900			9,200	8,700	8,300	8,200	11,400	10,200	9,300	8,800
105					8,800	8,400	8,100		10,900	9,900	9,100	8,600
110					8,400	8,100	8,000		10,400	9,500	8,800	8,500
115					8,100	7,900			10,000	9,200	8,600	8,300
120									9,600	8,900	8,400	8,200
125									9,300	8,700	8,300	8,200
130									8,900	8,400	8,100	
135									8,600	8,200	8,000	
140									8,300	8,000	8,000	
145									8,100	7,900		
Min Angle	0.0	0.0	0.0	0.0	0.0	0.0	0.0	0.0	0.0	0.0	0.0	0.0
Max Rad.	102.9	102.7	100.7	96.8	117.5	117.1	114.7	110.2	147.7	147.1	144.1	138.7
Capacity	6,200	6,400	7,000	8,200	3,600	3,700	4,100	4,700	2,600	2,600	2,900	3,400

1081080



PORTLAND OFFICE: 503.283.3111
 SEATTLE OFFICE: 206.784.1054
WWW.NESSCAMPBELL.COM

Rated Lifting Capacities in Pounds

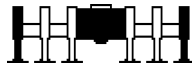

Full

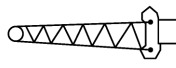

67ft Offset Fly



115,500 lbs



Radius (ft)	Boom Length (ft)											
	Fly Offset											
	120.3				152.4				169.0			
	2°	15°	30°	45°	2°	15°	30°	45°	2°	15°	30°	45°
25	19,500											
30	19,500											
35	19,500				16,600				15,500			
40	19,500				16,600				15,500			
45	19,500	18,400			16,600				15,500			
50	19,500	17,500			16,600	16,500			15,500			
55	19,500	16,600	13,500		16,600	16,500			15,500	15,500		
60	19,500	15,900	13,000		16,600	16,500			15,500	15,500		
65	18,900	15,200	12,600		16,600	16,400	13,100		15,500	15,500		
70	17,900	14,500	12,200	10,700	16,600	15,800	12,700		15,500	15,500	13,000	
75	17,000	14,000	11,800	10,400	16,600	15,200	12,400	10,700	15,500	15,500	12,600	
80	16,100	13,400	11,400	10,100	16,600	14,600	12,000	10,500	15,500	15,200	12,300	
85	15,400	12,900	11,100	9,900	16,600	14,100	11,700	10,200	15,500	14,700	12,000	10,400
90	14,700	12,400	10,700	9,700	16,600	13,600	11,400	10,000	15,500	14,200	11,700	10,200
95	14,000	12,000	10,400	9,500	16,100	13,200	11,100	9,800	15,500	13,700	11,400	10,000
100	13,400	11,600	10,200	9,300	15,400	12,800	10,800	9,700	15,500	13,300	11,100	9,800
105	12,900	11,200	9,900	9,100	14,800	12,400	10,600	9,500	15,500	12,900	10,900	9,700
110	12,400	10,800	9,600	8,900	14,300	12,000	10,300	9,300	15,200	12,500	10,600	9,500
115	11,900	10,500	9,400	8,800	13,700	11,600	10,100	9,200	14,600	12,200	10,400	9,300
120	11,500	10,200	9,200	8,600	13,300	11,300	9,900	9,000	14,100	11,800	10,200	9,200
125	11,100	9,900	9,000	8,500	12,800	11,000	9,700	8,900	13,600	11,500	10,000	9,100
130	10,700	9,600	8,800	8,400	12,400	10,700	9,500	8,800	13,200	11,200	9,800	8,900
135	10,300	9,300	8,600	8,300	12,000	10,400	9,300	8,700	12,800	10,900	9,600	8,800
140	10,000	9,100	8,500	8,200	11,300	10,200	9,100	8,500	12,400	10,700	9,400	8,700
145	9,600	8,900	8,300	8,200	10,700	9,900	8,900	8,500	11,800	10,400	9,200	8,600
150	9,300	8,700	8,200	8,200	10,200	9,700	8,800	8,400	11,200	10,200	9,100	8,500
155	9,100	8,500	8,100		9,600	9,400	8,600	8,300	10,700	9,900	8,900	8,400
160	8,800	8,300	8,000		9,100	9,200	8,500	8,200	10,200	9,700	8,800	8,300
165	8,500	8,100	8,000		8,600	8,800	8,400	8,200	9,700	9,500	8,700	8,300
170	8,300	8,000			8,200	8,400	8,300	8,100	9,200	9,300	8,500	8,200
175					7,800	7,900	8,100	8,100	8,700	8,900	8,400	8,200
180					7,400	7,500	7,600	7,700	8,300	8,500	8,300	8,100
185					7,000	7,100	7,200		7,900	8,100	8,200	8,100
190					6,600	6,700	6,800		7,500	7,700	7,800	7,800
195					6,300	6,400	6,400		7,200	7,300	7,400	7,400
200					5,900	6,000	6,100		6,800	6,900	7,000	
205					5,600	5,700			6,500	6,600	6,700	
210									6,200	6,300	6,300	
215									5,900	6,000	6,000	
220									5,600	5,700		
Min Angle	18.0	20.5	28.0	3.5	12.0	7.5	11.0	30.5	16.0	18.0	23.5	19.5
Max Rad.	175.0	175.0	170.0	163.0	210.0	209.5	204.1	195.0	225.0	225.0	220.0	211.7
Capacity	0	0	0	0	0	0	0	0	0	0	0	0

1081080



PORTLAND OFFICE: 503.283.3111
 SEATTLE OFFICE: 206.784.1054
WWW.NESSCAMPBELL.COM

Rated Lifting Capacities in Pounds

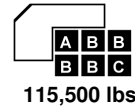
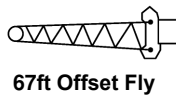
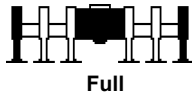

Radius (ft)	Boom Length (ft)			
	Fly Offset			
	185.5			
	2°	15°	30°	45°
40	13,500			
45	13,500			
50	13,500			
55	13,500			
60	13,500	13,500		
65	13,500	13,500		
70	13,500	13,500		
75	13,500	13,500	12,900	
80	13,500	13,500	12,500	
85	13,500	13,500	12,200	
90	13,500	13,500	11,900	10,300
95	13,500	13,500	11,700	10,100
100	13,500	13,500	11,400	10,000
105	13,500	13,400	11,100	9,800
110	13,500	13,000	10,900	9,600
115	13,500	12,700	10,700	9,500
120	13,500	12,300	10,500	9,400
125	13,500	12,000	10,200	9,200
130	13,500	11,700	10,000	9,100
135	13,500	11,400	9,900	9,000
140	13,100	11,100	9,700	8,900
145	12,700	10,900	9,500	8,800
150	12,200	10,600	9,400	8,700
155	11,600	10,400	9,200	8,600
160	11,100	10,200	9,100	8,500
165	10,600	9,900	8,900	8,400
170	10,100	9,700	8,800	8,300
175	9,600	9,500	8,700	8,300
180	9,200	9,300	8,500	8,200
185	8,600	8,900	8,400	8,200
190	8,000	8,500	8,300	8,100
195	7,400	7,900	8,200	8,100
200	6,800	7,300	7,700	7,800
205	6,300	6,700	7,100	7,200
210	5,800	6,200	6,500	6,500
215	5,300	5,700	5,900	
220	4,800	5,200	5,300	
225	4,400	4,700	4,800	
230	4,000	4,200	4,300	
235	3,600	3,800		
Min Angle	18.0	20.0	25.0	17.5
Max Rad.	240.0	240.0	235.0	228.2
Capacity	0	0	0	0

1081080



PORTLAND OFFICE: 503.283.3111
 SEATTLE OFFICE: 206.784.1054
WWW.NESSCAMPBELL.COM

Rated Lifting Capacities in Pounds

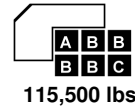
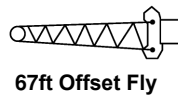
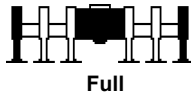

Radius (ft)	Boom Length (ft)											
	Fly Offset											
	44.3				73.5				103.8			
	2°	15°	30°	45°	2°	15°	30°	45°	2°	15°	30°	45°
15	30,000											
20	27,800				27,500							
25	24,600	19,800			27,500							
30	21,100	18,100			21,400				18,200			
35	19,100	16,600			21,400	18,500			18,200			
40	17,400	15,400	13,700		21,100	17,300			18,200			
45	16,000	14,300	12,800		19,500	16,200	13,700		18,200	17,700		
50	14,800	13,300	12,100		18,100	15,300	13,100		18,200	16,800		
55	13,800	12,500	11,400	10,600	16,900	14,400	12,400		18,200	15,900	13,200	
60	12,800	11,700	10,800	10,100	15,800	13,600	11,900	10,700	18,200	15,200	12,700	
65	12,000	11,100	10,300	9,700	14,900	12,900	11,400	10,300	17,500	14,500	12,200	10,800
70	11,200	10,500	9,800	9,300	14,000	12,300	10,900	10,000	16,600	13,800	11,800	10,500
75	10,600	9,900	9,300	8,900	13,200	11,700	10,500	9,700	15,700	13,200	11,400	10,200
80	10,000	9,400	8,900	8,600	12,500	11,200	10,100	9,400	14,900	12,700	11,000	9,900
85	9,400	9,000	8,600	8,400	11,900	10,700	9,800	9,100	14,200	12,200	10,600	9,700
90	8,900	8,600	8,300	8,200	11,300	10,300	9,400	8,900	13,500	11,700	10,300	9,400
95	8,500	8,200	8,000		10,800	9,900	9,100	8,700	12,900	11,300	10,000	9,200
100	8,100	7,900			10,300	9,500	8,900	8,500	12,400	10,900	9,700	9,000
105					9,800	9,100	8,600	8,300	11,800	10,500	9,500	8,900
110					9,400	8,800	8,400	8,200	11,400	10,200	9,200	8,700
115					9,000	8,500	8,200	8,200	10,900	9,800	9,000	8,500
120					8,700	8,300	8,000		10,500	9,500	8,800	8,400
125					8,300	8,100	8,000		10,100	9,300	8,600	8,300
130									9,800	9,000	8,400	8,200
135									9,400	8,800	8,300	8,200
140									9,100	8,500	8,200	8,200
145									8,800	8,300	8,000	
150									8,500	8,100	8,000	
155									8,300	8,000		
Min Angle	0.0	0.0	0.0	0.0	14.0	18.5	0.0	0.0	15.5	18.5	27.0	11.5
Max Rad.	102.9	102.7	100.7	96.8	130.0	130.0	128.9	123.9	160.0	160.0	155.0	146.4
Capacity	6,200	6,400	7,000	8,200	0	0	2,000	2,300	0	0	0	0

1081090



PORTLAND OFFICE: 503.283.3111
 SEATTLE OFFICE: 206.784.1054
WWW.NESSCAMPBELL.COM

Rated Lifting Capacities in Pounds

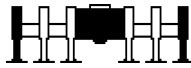

Full

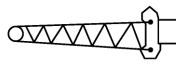

67ft Offset Fly



115,500 lbs



Radius (ft)	Boom Length (ft)											
	Fly Offset											
	119.4				135.4				152.0			
	2°	15°	30°	45°	2°	15°	30°	45°	2°	15°	30°	45°
30	17,800											
35	17,800				18,100				17,400			
40	17,800				18,100				17,400			
45	17,800				18,100	18,000			17,400			
50	17,800	17,400			18,100	18,000			17,400	17,300		
55	17,800	16,600			18,100	17,200			17,400	17,300		
60	17,800	15,800	13,000		18,100	16,500	13,300		17,400	17,100		
65	17,800	15,200	12,600		18,100	15,800	12,900		17,400	16,400	13,100	
70	17,800	14,500	12,100	10,600	18,100	15,100	12,500		17,400	15,700	12,700	
75	16,900	13,900	11,700	10,400	18,000	14,500	12,100	10,500	17,400	15,200	12,400	10,700
80	16,100	13,400	11,400	10,100	17,200	14,000	11,700	10,300	17,400	14,600	12,000	10,500
85	15,300	12,900	11,000	9,900	16,400	13,500	11,400	10,100	17,400	14,100	11,700	10,200
90	14,600	12,400	10,700	9,700	15,700	13,000	11,100	9,900	16,700	13,600	11,400	10,000
95	14,000	12,000	10,400	9,400	15,000	12,600	10,800	9,600	16,000	13,200	11,100	9,800
100	13,400	11,500	10,100	9,300	14,400	12,200	10,500	9,500	15,400	12,700	10,800	9,600
105	12,800	11,200	9,900	9,100	13,800	11,800	10,200	9,300	14,800	12,400	10,600	9,500
110	12,300	10,800	9,600	8,900	13,300	11,400	10,000	9,100	14,200	12,000	10,300	9,300
115	11,900	10,500	9,400	8,800	12,800	11,100	9,700	9,000	13,700	11,600	10,100	9,200
120	11,400	10,200	9,200	8,600	12,300	10,700	9,500	8,800	13,200	11,300	9,900	9,000
125	11,000	9,900	9,000	8,500	11,900	10,400	9,300	8,700	12,800	11,000	9,600	8,900
130	10,600	9,600	8,800	8,400	11,500	10,100	9,100	8,600	12,300	10,700	9,500	8,800
135	10,300	9,300	8,600	8,300	11,100	9,900	8,900	8,500	11,900	10,400	9,300	8,700
140	9,900	9,100	8,500	8,200	10,700	9,600	8,800	8,400	11,600	10,100	9,100	8,500
145	9,600	8,800	8,300	8,200	10,400	9,400	8,600	8,300	11,200	9,900	8,900	8,500
150	9,300	8,600	8,200	8,200	10,100	9,100	8,500	8,200	10,900	9,700	8,800	8,400
155	9,000	8,400	8,100		9,800	8,900	8,300	8,200	10,500	9,400	8,600	8,300
160	8,700	8,300	8,000		9,500	8,700	8,200	8,100	10,200	9,200	8,500	8,200
165	8,500	8,100	8,000		9,200	8,500	8,100	8,100	9,900	9,000	8,400	8,200
170	8,300	8,000			9,000	8,400	8,000		9,700	8,800	8,300	8,100
175					8,700	8,200	8,000		9,400	8,700	8,200	8,100
180					8,500	8,100	8,000		9,200	8,500	8,100	8,100
185					8,300	8,000			8,900	8,300	8,000	
190									8,700	8,200	8,000	
195									8,500	8,100	8,000	
200									8,300	8,000	8,000	
205									8,100			
Min Angle	16.5	19.5	27.0	12.5	18.0	20.5	27.0	12.5	8.5	22.5	9.0	10.0
Max Rad. Capacity	175.0	175.0	170.0	162.0	190.0	190.0	185.0	178.1	210.0	205.0	203.6	194.6
	0	0	0	0	0	0	0	0	0	0	0	0

1081090



PORTLAND OFFICE: 503.283.3111
 SEATTLE OFFICE: 206.784.1054
WWW.NESSCAMPBELL.COM

Rated Lifting Capacities in Pounds

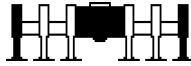

Full

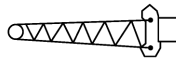

67ft Offset Fly

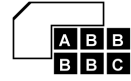

115,500 lbs



Radius (ft)	Boom Length (ft)			
	Fly Offset			
	168.5			
	2°	15°	30°	45°
35	15,300			
40	15,300			
45	15,300			
50	15,300			
55	15,300	15,200		
60	15,300	15,200		
65	15,300	15,200		
70	15,300	15,200	13,000	
75	15,300	15,200	12,600	
80	15,300	15,200	12,300	
85	15,300	14,600	12,000	10,400
90	15,300	14,200	11,700	10,200
95	15,300	13,700	11,400	10,000
100	15,300	13,300	11,100	9,800
105	15,300	12,900	10,900	9,600
110	15,200	12,500	10,600	9,500
115	14,600	12,200	10,400	9,300
120	14,100	11,800	10,200	9,200
125	13,600	11,500	10,000	9,100
130	13,200	11,200	9,800	8,900
135	12,700	10,900	9,600	8,800
140	12,400	10,600	9,400	8,700
145	12,000	10,400	9,200	8,600
150	11,600	10,100	9,100	8,500
155	11,300	9,900	8,900	8,400
160	10,900	9,700	8,800	8,300
165	10,600	9,500	8,700	8,300
170	10,400	9,300	8,500	8,200
175	10,100	9,100	8,400	8,200
180	9,800	8,900	8,300	8,100
185	9,600	8,700	8,200	8,100
190	9,000	8,600	8,100	8,100
195	8,400	8,400	8,100	8,100
200	7,800	8,200	8,000	
205	7,300	7,600	7,800	
210	6,800	7,100	7,200	
215	6,300	6,500	6,600	
220	5,900	6,000		
Min Angle	14.5	16.0	22.0	19.5
Max Rad.	225.0	225.0	220.0	211.2
Capacity	0	0	0	0

1081090



PORTLAND OFFICE: 503.283.3111
 SEATTLE OFFICE: 206.784.1054
WWW.NESSCAMPBELL.COM

Rated Lifting Capacities in Pounds

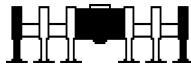

Full

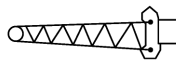

67ft Hydraulic Offset Fly



115,500 lbs



Radius (ft)	Boom Length (ft)											
	Fly Offset											
	44.3			73.5			103.8			134.9		
	2°-15°	15°-30°	30°-45°	2°-15°	15°-30°	30°-45°	2°-15°	15°-30°	30°-45°	2°-15°	15°-30°	30°-45°
15	30,000											
20	27,800			27,500								
25	19,800	19,800		27,500			18,200					
30	18,100	18,100		19,900	19,900		18,200			15,900		
35	16,600	16,600		18,500	18,500		18,200			15,900		
40	15,400	13,700	13,700	17,300	17,300		18,100	18,100		15,900		
45	14,300	12,800	12,800	16,200	13,700	13,700	17,700	17,700		15,800	15,800	
50	13,300	12,100	11,100	15,300	13,100	13,100	16,800	13,800	13,800	15,800	15,800	
55	12,500	11,400	10,600	14,400	12,400	11,100	15,900	13,200	13,200	15,800	15,800	
60	11,700	10,800	10,100	13,600	11,900	10,700	15,200	12,700	12,700	15,800	13,300	13,300
65	11,100	10,300	9,700	12,900	11,400	10,300	14,500	12,200	10,800	15,800	12,900	12,900
70	10,500	9,800	9,300	12,300	10,900	10,000	13,800	11,800	10,500	15,100	12,400	10,800
75	9,900	9,300	8,900	11,700	10,500	9,700	13,200	11,400	10,200	14,500	12,100	10,500
80	9,400	8,900	8,600	11,200	10,100	9,400	12,700	11,000	9,900	14,000	11,700	10,300
85	9,000	8,600	8,400	10,700	9,800	9,100	12,200	10,600	9,700	13,500	11,400	10,100
90	8,600	8,300	8,200	10,300	9,400	8,900	11,700	10,300	9,400	13,000	11,100	9,800
95	8,200	8,000	8,000	9,900	9,100	8,700	11,300	10,000	9,200	12,600	10,800	9,600
100	7,900	7,900		9,500	8,900	8,500	10,900	9,700	9,000	12,100	10,500	9,500
105				9,100	8,600	8,300	10,500	9,500	8,900	11,700	10,200	9,300
110				8,800	8,400	8,200	10,200	9,200	8,700	11,400	10,000	9,100
115				8,500	8,200	8,200	9,800	9,000	8,500	11,000	9,700	9,000
120				8,300	8,000	8,000	9,500	8,800	8,400	10,700	9,500	8,800
125				8,100	8,000	8,000	9,300	8,600	8,300	10,400	9,300	8,700
130							9,000	8,400	8,200	10,100	9,100	8,600
135							8,800	8,300	8,200	9,900	8,900	8,500
140							8,500	8,200	8,200	9,600	8,800	8,400
145							8,300	8,000	8,000	9,400	8,600	8,300
150							8,100	8,000		9,100	8,500	8,200
155							8,000			8,900	8,300	8,200
160										8,700	8,200	8,100
165										8,400	8,100	8,100
170										8,000	8,000	8,000
175										7,700	7,700	7,800
180										7,300	7,400	
185										7,000		
Min Angle	0.0	0.0	0.0	14.0	18.5	0.0	15.5	27.0	11.5	17.5	27.0	14.5
Max Rad.	102.9	102.7	100.7	130.0	130.0	128.9	160.0	155.0	146.4	190.0	185.0	177.6
Capacity	6,200	6,400	7,000	0	0	2,000	0	0	0	0	0	0

1082070



PORTLAND OFFICE: 503.283.3111
 SEATTLE OFFICE: 206.784.1054
WWW.NESSCAMPBELL.COM

Rated Lifting Capacities in Pounds

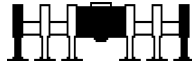

Full

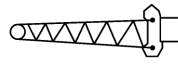

67ft Hydraulic Offset Fly



115,500 lbs



Radius (ft)	Boom Length (ft)								
	Fly Offset								
	167.1			183.6			200.1		
	2°-15°	15°-30°	30°-45°	2°-15°	15°-30°	30°-45°	2°-15°	15°-30°	30°-45°
35	13,300								
40	13,300			12,400					
45	13,300			12,400			10,800		
50	13,200	13,200		12,400			10,800		
55	13,200	13,200		12,300	12,300		10,800		
60	13,200	13,200		12,300	12,300		10,800	10,800	
65	13,200	13,200	13,200	12,300	12,300		10,800	10,800	
70	13,200	13,000	13,000	12,300	12,200	12,200	10,800	10,800	
75	13,200	12,600	12,600	12,300	12,200	12,200	10,800	10,700	10,700
80	13,200	12,300	10,600	12,300	12,200	12,200	10,800	10,700	10,700
85	13,200	12,000	10,400	12,300	12,200	10,500	10,800	10,700	10,700
90	13,200	11,600	10,200	12,300	11,900	10,300	10,800	10,700	10,400
95	13,200	11,400	10,000	12,300	11,600	10,100	10,800	10,700	10,300
100	13,200	11,100	9,800	12,300	11,400	10,000	10,800	10,700	10,100
105	12,900	10,800	9,600	12,300	11,100	9,800	10,800	10,700	9,900
110	12,500	10,600	9,500	12,300	10,900	9,600	10,800	10,700	9,800
115	12,100	10,400	9,300	12,300	10,600	9,500	10,800	10,700	9,600
120	11,800	10,100	9,200	12,300	10,400	9,300	10,800	10,700	9,500
125	11,500	9,900	9,000	12,000	10,200	9,200	10,800	10,500	9,400
130	11,200	9,700	8,900	11,600	10,000	9,100	10,800	10,300	9,200
135	10,900	9,500	8,800	11,400	9,800	9,000	10,800	10,100	9,100
140	10,600	9,400	8,700	11,100	9,600	8,900	10,800	9,900	9,000
145	10,300	9,200	8,600	10,800	9,500	8,700	10,800	9,700	8,900
150	9,800	9,000	8,500	10,600	9,300	8,600	10,800	9,600	8,800
155	9,300	8,900	8,400	10,300	9,200	8,600	10,800	9,400	8,700
160	8,800	8,800	8,300	9,800	9,000	8,500	10,500	9,300	8,600
165	8,300	8,500	8,300	9,300	8,900	8,400	10,100	9,100	8,500
170	7,800	8,100	8,200	8,800	8,800	8,300	9,700	9,000	8,400
175	7,400	7,600	7,800	8,300	8,500	8,300	9,200	8,900	8,400
180	7,000	7,200	7,400	7,900	8,100	8,200	8,800	8,700	8,300
185	6,600	6,800	7,000	7,500	7,700	7,800	8,400	8,500	8,300
190	6,300	6,400	6,600	7,200	7,300	7,500	8,000	8,100	8,200
195	5,900	6,100	6,200	6,800	6,900	7,100	7,600	7,700	7,800
200	5,600	5,700	5,800	6,400	6,600	6,700	7,100	7,400	7,500
205	5,300	5,400	5,400	6,100	6,300	6,400	6,600	7,000	7,100
210	5,000	5,100		5,800	5,900	6,000	6,100	6,500	6,800
215	4,700	4,800		5,500	5,600	5,700	5,600	6,000	6,300
220				5,200	5,300	5,400	5,100	5,500	5,800
225				5,000	5,100	5,000	4,700	5,000	5,300
230				4,700	4,800		4,300	4,600	4,700
235				4,500			3,900	4,100	4,200
240							3,500	3,700	3,600
245							3,100	3,300	
250							2,800		
Min Angle	22.5	13.5	14.0	16.0	22.5	22.0	18.0	24.5	20.5
Max Rad.	220.0	218.7	209.7	240.0	235.0	226.3	255.0	250.0	242.8
Capacity	0	0	0	0	0	0	0	0	0

1082070



PORTLAND OFFICE: 503.283.3111
 SEATTLE OFFICE: 206.784.1054
WWW.NESSCAMPBELL.COM

Rated Lifting Capacities in Pounds

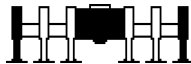

Full

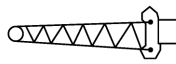

67ft Hydraulic Offset Fly

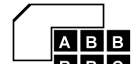

115,500 lbs



Radius (ft)	Boom Length (ft)											
	Fly Offset											
	44.3			58.9			89.1			120.3		
	2°-15°	15°-30°	30°-45°	2°-15°	15°-30°	30°-45°	2°-15°	15°-30°	30°-45°	2°-15°	15°-30°	30°-45°
15	30,000											
20	27,800			30,300			28,400					
25	19,800	19,800		26,900			28,400			19,500		
30	18,100	18,100		19,100	19,100		28,100			19,500		
35	16,600	16,600		17,700	17,700		19,300	19,300		19,500		
40	15,400	13,700	13,700	16,400	14,100	14,100	18,100	18,100		19,400	19,400	
45	14,300	12,800	12,800	15,300	13,300	13,300	17,000	14,100	14,100	18,400	18,400	
50	13,300	12,100	11,100	14,400	12,600	12,600	16,100	13,400	13,400	17,500	17,500	
55	12,500	11,400	10,600	13,500	12,000	10,900	15,200	12,900	12,900	16,600	13,500	13,500
60	11,700	10,800	10,100	12,700	11,400	10,400	14,500	12,300	10,900	15,900	13,000	13,000
65	11,100	10,300	9,700	12,100	10,900	10,000	13,800	11,800	10,600	15,200	12,600	10,900
70	10,500	9,800	9,300	11,400	10,400	9,700	13,100	11,400	10,300	14,500	12,200	10,700
75	9,900	9,300	8,900	10,900	10,000	9,300	12,500	11,000	10,000	14,000	11,800	10,400
80	9,400	8,900	8,600	10,400	9,600	9,000	12,000	10,600	9,700	13,400	11,400	10,100
85	9,000	8,600	8,400	9,900	9,200	8,800	11,500	10,200	9,400	12,900	11,100	9,900
90	8,600	8,300	8,200	9,500	8,900	8,600	11,100	9,900	9,200	12,400	10,700	9,700
95	8,200	8,000	8,000	9,100	8,600	8,400	10,600	9,600	9,000	12,000	10,400	9,500
100	7,900	7,900		8,700	8,300	8,200	10,200	9,300	8,800	11,600	10,200	9,300
105				8,400	8,100	8,100	9,900	9,100	8,600	11,200	9,900	9,100
110				8,100	8,000	8,000	9,500	8,800	8,500	10,800	9,600	8,900
115				7,900	7,900		9,200	8,600	8,300	10,500	9,400	8,800
120							8,900	8,400	8,200	10,200	9,200	8,600
125							8,700	8,300	8,200	9,900	9,000	8,500
130							8,400	8,100	8,100	9,600	8,800	8,400
135							8,200	8,000	8,000	9,300	8,600	8,300
140							8,000	8,000	8,000	9,100	8,500	8,200
145							7,900	7,900		8,900	8,300	8,200
150										8,700	8,200	8,200
155										8,500	8,100	8,100
160										8,300	8,000	8,000
165										8,100	8,000	
170										8,000		
Min Angle	0.0	0.0	0.0	0.0	0.0	0.0	0.0	0.0	0.0	18.0	28.0	3.5
Max Rad.	102.9	102.7	100.7	117.5	117.1	114.7	147.7	147.1	144.1	175.0	170.0	163.0
Capacity	6,200	6,400	7,000	3,600	3,700	4,100	2,600	2,600	2,900	0	0	0

1082080



PORTLAND OFFICE: 503.283.3111
 SEATTLE OFFICE: 206.784.1054
WWW.NESSCAMPBELL.COM

Rated Lifting Capacities in Pounds

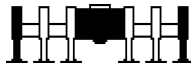

Full

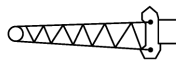

67ft Hydraulic Offset Fly

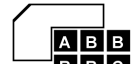

115,500 lbs



Radius (ft)	Boom Length (ft)								
	Fly Offset								
	152.4			169.0			185.5		
	2°-15°	15°-30°	30°-45°	2°-15°	15°-30°	30°-45°	2°-15°	15°-30°	30°-45°
35	16,600			15,500					
40	16,600			15,500			13,500		
45	16,600			15,500			13,500		
50	16,500	16,500		15,400	15,400		13,500		
55	16,500	16,500		15,400	15,400		13,500	13,500	
60	16,500	16,500		15,400	15,400		13,500	13,500	
65	16,400	13,100	13,100	15,400	13,400	13,400	13,500	13,500	
70	15,800	12,700	12,700	15,400	13,000	13,000	13,500	13,200	13,200
75	15,200	12,400	10,700	15,400	12,600	12,600	13,500	12,900	12,900
80	14,600	12,000	10,500	15,200	12,300	10,600	13,500	12,500	12,500
85	14,100	11,700	10,200	14,700	12,000	10,400	13,500	12,200	10,500
90	13,600	11,400	10,000	14,200	11,700	10,200	13,500	11,900	10,300
95	13,200	11,100	9,800	13,700	11,400	10,000	13,500	11,700	10,100
100	12,800	10,800	9,700	13,300	11,100	9,800	13,500	11,400	10,000
105	12,400	10,600	9,500	12,900	10,900	9,700	13,400	11,100	9,800
110	12,000	10,300	9,300	12,500	10,600	9,500	13,000	10,900	9,600
115	11,600	10,100	9,200	12,200	10,400	9,300	12,700	10,700	9,500
120	11,300	9,900	9,000	11,800	10,200	9,200	12,300	10,500	9,400
125	11,000	9,700	8,900	11,500	10,000	9,100	12,000	10,200	9,200
130	10,700	9,500	8,800	11,200	9,800	8,900	11,700	10,000	9,100
135	10,400	9,300	8,700	10,900	9,600	8,800	11,400	9,900	9,000
140	10,200	9,100	8,500	10,700	9,400	8,700	11,100	9,700	8,900
145	9,900	8,900	8,500	10,400	9,200	8,600	10,900	9,500	8,800
150	9,700	8,800	8,400	10,200	9,100	8,500	10,600	9,400	8,700
155	9,400	8,600	8,300	9,900	8,900	8,400	10,400	9,200	8,600
160	9,100	8,500	8,200	9,700	8,800	8,300	10,200	9,100	8,500
165	8,600	8,400	8,200	9,500	8,700	8,300	9,900	8,900	8,400
170	8,200	8,300	8,100	9,200	8,500	8,200	9,700	8,800	8,300
175	7,800	7,900	8,100	8,700	8,400	8,200	9,500	8,700	8,300
180	7,400	7,500	7,600	8,300	8,300	8,100	9,200	8,500	8,200
185	7,000	7,100	7,200	7,900	8,100	8,100	8,600	8,400	8,200
190	6,600	6,700	6,800	7,500	7,700	7,800	8,000	8,300	8,100
195	6,300	6,400		7,200	7,300	7,400	7,400	7,900	8,100
200	5,900	6,000		6,800	6,900	7,000	6,800	7,300	7,700
205	5,600			6,500	6,600	6,700	6,300	6,700	7,100
210				6,200	6,300	6,300	5,800	6,200	6,500
215				5,900	6,000		5,300	5,700	5,900
220				5,600			4,800	5,200	5,200
225							4,400	4,700	4,600
230							4,000	4,200	
235							3,600		

Min Angle	7.5	11.0	30.5	16.0	23.5	19.5	18.0	25.0	17.5
Max Rad. Capacity	209.5	204.1	195.0	225.0	220.0	211.7	240.0	235.0	228.2
	0	0	0	0	0	0	0	0	0

1082080



PORTLAND OFFICE: 503.283.3111
 SEATTLE OFFICE: 206.784.1054
WWW.NESSCAMPBELL.COM

Rated Lifting Capacities in Pounds

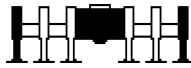

Full

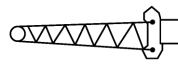

67ft Hydraulic Offset Fly

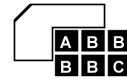

115,500 lbs



Radius (ft)	Boom Length (ft)											
	Fly Offset											
	44.3			73.5			103.8			119.4		
	2°-15°	15°-30°	30°-45°	2°-15°	15°-30°	30°-45°	2°-15°	15°-30°	30°-45°	2°-15°	15°-30°	30°-45°
15	30,000											
20	27,800			27,500								
25	19,800	19,800		27,500			18,200					
30	18,100	18,100		19,900	19,900		18,200			17,800		
35	16,600	16,600		18,500	18,500		18,200			17,800		
40	15,400	13,700	13,700	17,300	17,300		18,100	18,100		17,700	17,700	
45	14,300	12,800	12,800	16,200	13,700	13,700	17,700	17,700		17,700	17,700	
50	13,300	12,100	11,100	15,300	13,100	13,100	16,800	13,800	13,800	17,400	17,400	
55	12,500	11,400	10,600	14,400	12,400	11,100	15,900	13,200	13,200	16,600	13,500	13,500
60	11,700	10,800	10,100	13,600	11,900	10,700	15,200	12,700	12,700	15,800	13,000	13,000
65	11,100	10,300	9,700	12,900	11,400	10,300	14,500	12,200	10,800	15,200	12,600	12,600
70	10,500	9,800	9,300	12,300	10,900	10,000	13,800	11,800	10,500	14,500	12,100	10,600
75	9,900	9,300	8,900	11,700	10,500	9,700	13,200	11,400	10,200	13,900	11,700	10,400
80	9,400	8,900	8,600	11,200	10,100	9,400	12,700	11,000	9,900	13,400	11,400	10,100
85	9,000	8,600	8,400	10,700	9,800	9,100	12,200	10,600	9,700	12,900	11,000	9,900
90	8,600	8,300	8,200	10,300	9,400	8,900	11,700	10,300	9,400	12,400	10,700	9,700
95	8,200	8,000	8,000	9,900	9,100	8,700	11,300	10,000	9,200	12,000	10,400	9,400
100	7,900	7,900		9,500	8,900	8,500	10,900	9,700	9,000	11,500	10,100	9,300
105				9,100	8,600	8,300	10,500	9,500	8,900	11,200	9,900	9,100
110				8,800	8,400	8,200	10,200	9,200	8,700	10,800	9,600	8,900
115				8,500	8,200	8,200	9,800	9,000	8,500	10,500	9,400	8,800
120				8,300	8,000	8,000	9,500	8,800	8,400	10,200	9,200	8,600
125				8,100	8,000	8,000	9,300	8,600	8,300	9,900	9,000	8,500
130							9,000	8,400	8,200	9,600	8,800	8,400
135							8,800	8,300	8,200	9,300	8,600	8,300
140							8,500	8,200	8,200	9,100	8,500	8,200
145							8,300	8,000	8,000	8,800	8,300	8,200
150							8,100	8,000		8,600	8,200	8,200
155							8,000			8,400	8,100	8,100
160										8,300	8,000	8,000
165										8,100	8,000	
170										8,000		
Min Angle	0.0	0.0	0.0	14.0	18.5	0.0	15.5	27.0	11.5	16.5	27.0	12.5
Max Rad.	102.9	102.7	100.7	130.0	130.0	128.9	160.0	155.0	146.4	175.0	170.0	162.0
Capacity	6,200	6,400	7,000	0	0	2,000	0	0	0	0	0	0

1082090



PORTLAND OFFICE: 503.283.3111
 SEATTLE OFFICE: 206.784.1054
WWW.NESSCAMPBELL.COM

Rated Lifting Capacities in Pounds

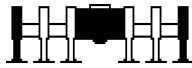

Full

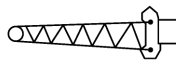

67ft Hydraulic Offset Fly



115,500 lbs



Radius (ft)	Boom Length (ft)								
	Fly Offset								
	135.4			152.0			168.5		
	2°-15°	15°-30°	30°-45°	2°-15°	15°-30°	30°-45°	2°-15°	15°-30°	30°-45°
35	18,100			17,400			15,300		
40	18,100			17,400			15,300		
45	18,000	18,000		17,400			15,300		
50	18,000	18,000		17,300	17,300		15,200	15,200	
55	17,200	17,200		17,300	17,300		15,200	15,200	
60	16,500	13,300	13,300	17,100	17,100		15,200	15,200	
65	15,800	12,900	12,900	16,400	13,100	13,100	15,200	15,200	
70	15,100	12,500	12,500	15,700	12,700	10,900	15,200	13,000	13,000
75	14,500	12,100	10,500	15,200	12,400	10,700	15,200	12,600	12,600
80	14,000	11,700	10,300	14,600	12,000	10,500	15,200	12,300	10,600
85	13,500	11,400	10,100	14,100	11,700	10,200	14,600	12,000	10,400
90	13,000	11,100	9,900	13,600	11,400	10,000	14,200	11,700	10,200
95	12,600	10,800	9,600	13,200	11,100	9,800	13,700	11,400	10,000
100	12,200	10,500	9,500	12,700	10,800	9,600	13,300	11,100	9,800
105	11,800	10,200	9,300	12,400	10,600	9,500	12,900	10,900	9,600
110	11,400	10,000	9,100	12,000	10,300	9,300	12,500	10,600	9,500
115	11,100	9,700	9,000	11,600	10,100	9,200	12,200	10,400	9,300
120	10,700	9,500	8,800	11,300	9,900	9,000	11,800	10,200	9,200
125	10,400	9,300	8,700	11,000	9,600	8,900	11,500	10,000	9,100
130	10,100	9,100	8,600	10,700	9,500	8,800	11,200	9,800	8,900
135	9,900	8,900	8,500	10,400	9,300	8,700	10,900	9,600	8,800
140	9,600	8,800	8,400	10,100	9,100	8,500	10,600	9,400	8,700
145	9,400	8,600	8,300	9,900	8,900	8,500	10,400	9,200	8,600
150	9,100	8,500	8,200	9,700	8,800	8,400	10,100	9,100	8,500
155	8,900	8,300	8,200	9,400	8,600	8,300	9,900	8,900	8,400
160	8,700	8,200	8,100	9,200	8,500	8,200	9,700	8,800	8,300
165	8,500	8,100	8,100	9,000	8,400	8,200	9,500	8,700	8,300
170	8,400	8,000	8,000	8,800	8,300	8,100	9,300	8,500	8,200
175	8,200	8,000	8,000	8,700	8,200	8,100	9,100	8,400	8,200
180	8,100	8,000		8,500	8,100	8,100	8,900	8,300	8,100
185	8,000			8,300	8,000	8,000	8,700	8,200	8,100
190				8,200	8,000	8,000	8,600	8,100	8,100
195				8,100	8,000		8,400	8,100	8,100
200				8,000	8,000		7,800	8,000	8,000
205							7,300	7,600	7,700
210							6,800	7,100	7,000
215							6,300	6,500	
220							5,900		
Min Angle	18.0	27.0	12.5	22.5	9.0	10.0	14.5	22.0	19.5
Max Rad.	190.0	185.0	178.1	205.0	203.6	194.6	225.0	220.0	211.2
Capacity	0	0	0	0	0	0	0	0	0

1082090



PORTLAND OFFICE: 503.283.3111
 SEATTLE OFFICE: 206.784.1054
WWW.NESSCAMPBELL.COM

Rated Lifting Capacities in Pounds

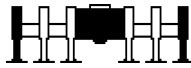

Full

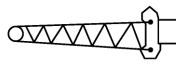

92ft Offset Fly



115,500 lbs



Radius (ft)	Boom Length (ft)											
	Fly Offset											
	44.3				73.5				103.8			
	2°	15°	30°	45°	2°	15°	30°	45°	2°	15°	30°	45°
20	19,800											
25	18,100				17,300							
30	16,700				17,300				15,200			
35	15,500	14,400			17,300				15,200			
40	14,400	13,400			16,300	14,600			15,200			
45	13,400	12,600	11,900		15,300	13,800			15,200	14,700		
50	12,600	11,800	11,200		14,400	13,100			15,200	14,000		
55	11,800	11,200	10,600		13,600	12,400	11,400		15,200	13,400		
60	11,100	10,500	10,000	9,700	12,900	11,800	10,900		14,400	12,800	11,500	
65	10,500	10,000	9,500	9,300	12,200	11,200	10,400	9,800	13,700	12,200	11,000	
70	9,900	9,500	9,100	8,800	11,600	10,700	10,000	9,400	13,100	11,700	10,600	9,800
75	9,400	9,000	8,700	8,400	11,000	10,200	9,500	9,100	12,500	11,300	10,200	9,500
80	8,900	8,600	8,300	8,100	10,500	9,800	9,200	8,700	12,000	10,800	9,900	9,200
85	8,400	8,100	7,800	7,700	10,000	9,400	8,800	8,400	11,500	10,400	9,500	8,900
90	7,900	7,700	7,400	7,300	9,600	9,000	8,500	8,200	11,000	10,000	9,200	8,700
95	7,400	7,200	7,100	7,000	9,200	8,700	8,200	7,900	10,600	9,700	8,900	8,400
100	7,000	6,800	6,700	6,600	8,800	8,300	7,800	7,600	10,200	9,300	8,600	8,200
105	6,500	6,400	6,300	6,300	8,400	7,900	7,500	7,300	9,800	9,000	8,400	8,000
110	6,100	6,000	6,000	6,000	8,000	7,600	7,200	7,000	9,400	8,700	8,100	7,700
115	5,800	5,700	5,700		7,600	7,200	6,900	6,800	9,100	8,400	7,800	7,500
120	5,400	5,400	5,400		7,200	6,900	6,600	6,500	8,800	8,100	7,600	7,300
125	5,100	5,100			6,800	6,500	6,300	6,300	8,400	7,800	7,300	7,100
130					6,500	6,200	6,100	6,100	8,100	7,500	7,100	6,900
135					6,100	6,000	5,800	5,900	7,700	7,200	6,800	6,700
140					5,800	5,700	5,600		7,400	6,900	6,600	6,400
145					5,600	5,500	5,400		7,000	6,700	6,400	6,300
150					5,300	5,200			6,700	6,400	6,200	6,100
155									6,400	6,200	6,000	5,900
160									6,200	5,900	5,800	5,800
165									5,900	5,700	5,600	
170									5,700	5,500	5,400	
175									5,500	5,300	5,300	
180									5,300	5,200		
Min Angle	0.0	0.0	0.0	0.0	14.0	17.0	26.5	26.0	15.5	17.5	25.0	22.5
Max Rad.	127.9	127.5	124.9	120.1	155.0	155.0	150.0	141.2	185.0	185.0	180.0	171.4
Capacity	3,100	3,100	3,400	3,900	0	0	0	0	0	0	0	0

1081100



PORTLAND OFFICE: 503.283.3111
 SEATTLE OFFICE: 206.784.1054
WWW.NESSCAMPBELL.COM

Rated Lifting Capacities in Pounds

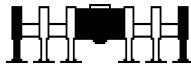

Full

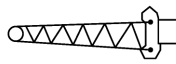

92ft Offset Fly

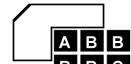

115,500 lbs



Radius (ft)	Boom Length (ft)											
	Fly Offset											
	134.9				167.1				183.6			
	2°	15°	30°	45°	2°	15°	30°	45°	2°	15°	30°	45°
35	12,900											
40	12,900											
45	12,900				10,400							
50	12,900				10,400				9,600			
55	12,900	12,800			10,400				9,600			
60	12,900	12,800			10,400	10,300			9,600			
65	12,900	12,800			10,400	10,300			9,600			
70	12,900	12,600	11,200		10,400	10,300			9,600	9,500		
75	12,900	12,200	10,800		10,400	10,300			9,600	9,500		
80	12,900	11,700	10,500	9,600	10,400	10,300	10,200		9,600	9,500		
85	12,800	11,300	10,100	9,300	10,400	10,300	10,200		9,600	9,500	9,400	
90	12,300	10,900	9,800	9,100	10,400	10,300	10,200	9,400	9,600	9,500	9,400	
95	11,800	10,600	9,500	8,900	10,400	10,300	10,100	9,200	9,600	9,500	9,400	9,300
100	11,400	10,200	9,300	8,600	10,400	10,300	9,800	9,000	9,600	9,500	9,400	9,100
105	11,000	9,900	9,000	8,400	10,400	10,300	9,500	8,800	9,600	9,500	9,400	9,000
110	10,600	9,600	8,800	8,200	10,400	10,300	9,300	8,600	9,600	9,500	9,400	8,800
115	10,300	9,300	8,500	8,000	10,400	10,100	9,100	8,400	9,600	9,500	9,300	8,600
120	9,900	9,000	8,300	7,800	10,400	9,800	8,900	8,300	9,600	9,500	9,100	8,400
125	9,600	8,800	8,100	7,600	10,400	9,600	8,700	8,100	9,600	9,500	8,900	8,300
130	9,300	8,500	7,900	7,400	10,400	9,300	8,500	7,900	9,600	9,500	8,700	8,100
135	9,000	8,300	7,600	7,300	10,000	9,100	8,300	7,700	9,600	9,400	8,500	8,000
140	8,700	8,000	7,400	7,100	9,800	8,800	8,100	7,600	9,600	9,200	8,300	7,800
145	8,400	7,700	7,200	6,900	9,300	8,600	7,900	7,400	9,600	9,000	8,200	7,600
150	8,100	7,500	7,000	6,700	8,800	8,400	7,700	7,200	9,600	8,800	8,000	7,500
155	7,800	7,200	6,800	6,600	8,300	8,200	7,500	7,100	9,100	8,600	7,800	7,300
160	7,500	7,000	6,600	6,400	7,800	7,900	7,300	7,000	8,600	8,300	7,600	7,200
165	7,200	6,800	6,400	6,300	7,300	7,600	7,100	6,800	8,200	8,100	7,400	7,000
170	6,900	6,500	6,200	6,100	6,900	7,200	7,000	6,700	7,700	7,900	7,300	6,900
175	6,500	6,300	6,000	6,000	6,500	6,800	6,800	6,500	7,300	7,500	7,100	6,800
180	6,200	6,100	5,900	5,900	6,100	6,400	6,600	6,400	6,900	7,100	6,900	6,600
185	5,900	5,900	5,700	5,800	5,700	6,000	6,200	6,300	6,500	6,700	6,800	6,500
190	5,500	5,700	5,600		5,300	5,600	5,800	5,900	6,100	6,300	6,600	6,400
195	5,200	5,400	5,400		5,000	5,200	5,400	5,600	5,800	6,000	6,200	6,300
200	5,000	5,100	5,100		4,700	4,900	5,100	5,200	5,400	5,600	5,800	5,900
205	4,700	4,800	4,800		4,400	4,600	4,800	4,800	5,100	5,300	5,500	5,600
210	4,500	4,500			4,100	4,300	4,400	4,500	4,800	5,000	5,200	5,200
215					3,800	4,000	4,100	4,100	4,500	4,700	4,900	4,900
220					3,500	3,700	3,800		4,200	4,400	4,500	4,600
225					3,300	3,400	3,500		4,000	4,100	4,300	4,300
230					3,000	3,200	3,200		3,700	3,900	4,000	4,000
235					2,800	2,900	3,000		3,500	3,600	3,700	
240					2,600	2,700			3,200	3,300	3,400	
245					2,400				3,000	3,100	3,200	
250									2,800	2,900	2,900	
255									2,600	2,700	2,700	
260									2,400	2,500		
Min Angle	18.0	20.0	26.0	19.5	19.0	22.0	19.0	21.5	16.5	17.5	22.5	25.5
Max Rad.	215.0	215.0	210.0	202.6	245.8	245.0	243.7	234.7	265.0	265.0	260.0	251.3
Capacity	0	0	0	0	0	0	0	0	0	0	0	0

1081100



PORTLAND OFFICE: 503.283.3111
SEATTLE OFFICE: 206.784.1054

WWW.NESSCAMPBELL.COM

Rated Lifting Capacities in Pounds

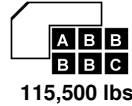
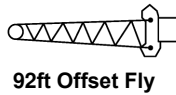
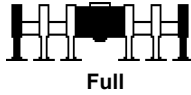

Radius (ft)	Boom Length (ft)			
	Fly Offset			
	200.1			
	2°	15°	30°	45°
55	8,200			
60	8,200			
65	8,200			
70	8,200			
75	8,200	8,100		
80	8,200	8,100		
85	8,200	8,100		
90	8,200	8,100	8,000	
95	8,200	8,100	8,000	
100	8,200	8,100	8,000	7,800
105	8,200	8,100	8,000	7,800
110	8,200	8,100	8,000	7,800
115	8,200	8,100	8,000	7,800
120	8,200	8,100	8,000	7,800
125	8,200	8,100	8,000	7,800
130	8,200	8,100	8,000	7,800
135	8,200	8,100	8,000	7,800
140	8,200	8,100	8,000	7,800
145	8,200	8,100	8,000	7,800
150	8,200	8,100	8,000	7,700
155	8,200	8,100	8,000	7,500
160	8,200	8,100	7,900	7,400
165	8,200	8,100	7,700	7,200
170	8,200	8,100	7,500	7,100
175	8,000	8,100	7,400	7,000
180	7,600	7,800	7,200	6,900
185	7,200	7,400	7,100	6,700
190	6,800	7,000	6,900	6,600
195	6,500	6,700	6,800	6,500
200	6,100	6,300	6,500	6,400
205	5,800	6,000	6,100	6,200
210	5,500	5,600	5,800	5,900
215	5,200	5,300	5,500	5,600
220	4,900	5,000	5,200	5,300
225	4,500	4,800	4,900	5,000
230	4,100	4,500	4,600	4,700
235	3,700	4,100	4,300	4,400
240	3,300	3,700	4,000	4,000
245	2,900	3,300	3,500	3,500
250	2,600	2,900	3,100	
255	2,300	2,500	2,700	
260		2,200	2,300	
Min Angle	33.0	33.5	33.5	32.5
Max Rad.	260.0	263.3	263.8	262.0
Capacity	0	0	0	0

1081100



PORTLAND OFFICE: 503.283.3111
 SEATTLE OFFICE: 206.784.1054
WWW.NESSCAMPBELL.COM

Rated Lifting Capacities in Pounds

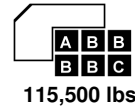
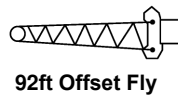
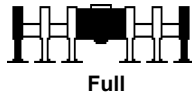

Radius (ft)	Boom Length (ft)											
	Fly Offset											
	44.3				58.9				89.1			
	2°	15°	30°	45°	2°	15°	30°	45°	2°	15°	30°	45°
20	19,800				19,700							
25	18,100				19,200				18,900			
30	16,700				17,700				18,900			
35	15,500	14,400			16,500	15,000			18,300			
40	14,400	13,400			15,400	14,100			17,100	15,100		
45	13,400	12,600	11,900		14,400	13,300			16,200	14,300		
50	12,600	11,800	11,200		13,500	12,500	11,600		15,300	13,600		
55	11,800	11,200	10,600		12,700	11,800	11,000		14,400	12,900	11,700	
60	11,100	10,500	10,000	9,700	12,000	11,200	10,500	10,000	13,700	12,300	11,200	
65	10,500	10,000	9,500	9,300	11,400	10,600	10,000	9,600	13,000	11,800	10,700	
70	9,900	9,500	9,100	8,800	10,800	10,100	9,600	9,200	12,400	11,300	10,300	9,700
75	9,400	9,000	8,700	8,400	10,200	9,600	9,100	8,800	11,800	10,800	9,900	9,300
80	8,900	8,600	8,300	8,100	9,700	9,200	8,700	8,400	11,300	10,400	9,600	9,000
85	8,400	8,100	7,800	7,700	9,300	8,800	8,400	8,100	10,800	9,900	9,200	8,700
90	7,900	7,700	7,400	7,300	8,900	8,400	8,000	7,800	10,300	9,600	8,900	8,400
95	7,400	7,200	7,100	7,000	8,400	8,000	7,700	7,500	9,900	9,200	8,600	8,200
100	7,000	6,800	6,700	6,600	8,000	7,600	7,300	7,200	9,500	8,900	8,300	7,900
105	6,500	6,400	6,300	6,300	7,500	7,200	7,000	6,900	9,200	8,500	8,000	7,700
110	6,100	6,000	6,000	6,000	7,100	6,800	6,600	6,600	8,800	8,200	7,700	7,400
115	5,800	5,700	5,700		6,700	6,500	6,300	6,300	8,400	7,900	7,400	7,200
120	5,400	5,400	5,400		6,300	6,200	6,000	6,000	8,000	7,600	7,200	7,000
125	5,100	5,100			6,000	5,800	5,800		7,700	7,200	6,900	6,700
130					5,700	5,600	5,500		7,300	6,900	6,600	6,500
135					5,400	5,300			7,000	6,600	6,400	6,300
140									6,600	6,300	6,100	6,100
145									6,300	6,100	5,900	5,900
150									6,000	5,800	5,700	
155									5,800	5,600	5,500	
160									5,500	5,400	5,400	
165									5,300	5,200		
Min Angle	0.0	0.0	0.0	0.0	14.5	18.5	28.5	9.5	15.0	18.0	26.0	18.5
Max Rad.	127.9	127.5	124.9	120.1	140.0	140.0	135.0	126.6	170.0	170.0	165.0	156.8
Capacity	3,100	3,100	3,400	3,900	0	0	0	0	0	0	0	0

1081110



PORTLAND OFFICE: 503.283.3111
 SEATTLE OFFICE: 206.784.1054
WWW.NESSCAMPBELL.COM

Rated Lifting Capacities in Pounds

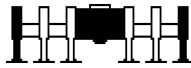

Full

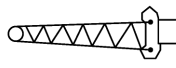

92ft Offset Fly

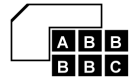

115,500 lbs



Radius (ft)	Boom Length (ft)											
	Fly Offset											
	120.3				152.4				169.0			
	2°	15°	30°	45°	2°	15°	30°	45°	2°	15°	30°	45°
35	16,500											
40	16,500				13,500							
45	16,500				13,500							
50	16,500	14,500			13,500				12,500			
55	15,900	13,900			13,500				12,500			
60	15,200	13,300			13,500	13,400			12,500			
65	14,500	12,700	11,300		13,500	13,400			12,500	12,400		
70	13,800	12,200	10,900		13,500	13,000			12,500	12,400		
75	13,200	11,800	10,500	9,700	13,500	12,600	11,100		12,500	12,400		
80	12,700	11,300	10,200	9,400	13,500	12,200	10,700		12,500	12,400	10,900	
85	12,200	10,900	9,900	9,200	13,400	11,800	10,400	9,500	12,500	12,100	10,700	
90	11,700	10,500	9,600	8,900	12,900	11,400	10,100	9,300	12,500	11,800	10,400	
95	11,200	10,200	9,300	8,700	12,500	11,000	9,800	9,100	12,500	11,400	10,100	9,200
100	10,800	9,800	9,000	8,400	12,000	10,700	9,600	8,800	12,500	11,100	9,800	9,000
105	10,400	9,500	8,700	8,200	11,600	10,300	9,300	8,600	12,200	10,700	9,600	8,800
110	10,100	9,200	8,500	8,000	11,200	10,000	9,100	8,400	11,800	10,400	9,300	8,600
115	9,700	8,900	8,300	7,800	10,900	9,800	8,800	8,300	11,400	10,100	9,100	8,500
120	9,400	8,600	8,000	7,600	10,500	9,500	8,600	8,100	11,100	9,900	8,900	8,300
125	9,100	8,400	7,700	7,400	10,200	9,200	8,400	7,900	10,700	9,600	8,700	8,100
130	8,800	8,100	7,500	7,200	9,900	9,000	8,200	7,700	10,400	9,300	8,500	7,900
135	8,400	7,800	7,300	7,000	9,600	8,700	8,000	7,500	10,100	9,100	8,300	7,800
140	8,100	7,500	7,100	6,800	9,300	8,500	7,800	7,400	9,800	8,900	8,100	7,600
145	7,800	7,300	6,800	6,600	9,000	8,200	7,600	7,200	9,500	8,700	7,900	7,400
150	7,500	7,000	6,600	6,500	8,800	8,000	7,400	7,000	9,300	8,400	7,700	7,300
155	7,200	6,700	6,400	6,300	8,500	7,800	7,200	6,900	9,000	8,200	7,500	7,100
160	6,900	6,500	6,200	6,100	8,200	7,500	7,000	6,700	8,800	8,000	7,300	7,000
165	6,600	6,300	6,000	6,000	7,700	7,300	6,800	6,600	8,500	7,800	7,200	6,800
170	6,400	6,100	5,900	5,800	7,200	7,100	6,600	6,400	8,100	7,500	7,000	6,700
175	6,100	5,900	5,700		6,800	6,900	6,500	6,300	7,700	7,300	6,800	6,600
180	5,900	5,700	5,500		6,400	6,600	6,300	6,200	7,300	7,100	6,600	6,400
185	5,700	5,500	5,400		6,000	6,300	6,100	6,000	6,900	6,900	6,500	6,300
190	5,500	5,300	5,300		5,700	5,900	6,000	5,900	6,500	6,700	6,300	6,200
195	5,300	5,200			5,300	5,500	5,700	5,800	6,100	6,300	6,200	6,100
200					5,000	5,200	5,400	5,400	5,800	6,000	6,000	5,900
205					4,700	4,900	5,000		5,500	5,600	5,800	5,800
210					4,400	4,600	4,700		5,200	5,300	5,500	5,500
215					4,100	4,300	4,300		4,900	5,000	5,100	5,200
220					3,900	4,000	4,000		4,600	4,700	4,800	
225					3,600	3,700			4,300	4,500	4,500	
230					3,400	3,400			4,100	4,200	4,300	
235									3,800	3,900	4,000	
240									3,600	3,700	3,700	
245									3,400	3,400		
Min Angle	18.0	20.0	26.5	17.0	12.5	13.5	15.5	28.5	16.5	18.0	23.0	23.0
Max Rad. Capacity	200.0	200.0	195.0	188.0	235.0	233.9	229.1	220.0	250.0	250.0	245.0	236.6
Capacity	0	0	0	0	0	0	0	0	0	0	0	0

1081110



PORTLAND OFFICE: 503.283.3111
 SEATTLE OFFICE: 206.784.1054
WWW.NESSCAMPBELL.COM

Rated Lifting Capacities in Pounds

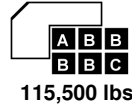
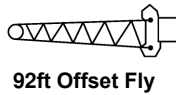
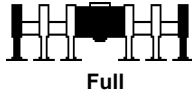

Radius (ft)	Boom Length (ft)			
	Fly Offset			
	185.5			
	2°	15°	30°	45°
50	10,700			
55	10,700			
60	10,700			
65	10,700			
70	10,700	10,600		
75	10,700	10,600		
80	10,700	10,600		
85	10,700	10,600	10,400	
90	10,700	10,600	10,400	
95	10,700	10,600	10,300	
100	10,700	10,600	10,100	9,200
105	10,700	10,600	9,800	9,000
110	10,700	10,600	9,600	8,800
115	10,700	10,500	9,400	8,600
120	10,700	10,200	9,100	8,400
125	10,700	10,000	8,900	8,300
130	10,700	9,700	8,700	8,100
135	10,600	9,500	8,500	8,000
140	10,300	9,200	8,400	7,800
145	10,000	9,000	8,200	7,600
150	9,800	8,800	8,000	7,500
155	9,500	8,600	7,800	7,300
160	9,300	8,400	7,600	7,200
165	9,000	8,200	7,500	7,100
170	8,800	8,000	7,300	6,900
175	8,400	7,700	7,100	6,800
180	8,000	7,600	7,000	6,700
185	7,600	7,400	6,800	6,500
190	7,200	7,200	6,600	6,400
195	6,800	7,000	6,500	6,300
200	6,500	6,700	6,300	6,200
205	6,200	6,300	6,200	6,100
210	5,700	6,000	6,100	6,000
215	5,200	5,700	5,800	5,900
220	4,800	5,200	5,500	5,600
225	4,300	4,700	5,100	5,100
230	3,900	4,300	4,600	4,600
235	3,500	3,900	4,100	
240	3,100	3,400	3,600	
245	2,800	3,000	3,200	
250	2,400	2,700	2,800	
255	2,100	2,300	2,300	
Min Angle	26.0	26.5	25.5	24.0
Max Rad.	256.7	258.8	258.8	253.2
Capacity	0	0	0	0

1081110



PORTLAND OFFICE: 503.283.3111
 SEATTLE OFFICE: 206.784.1054
WWW.NESSCAMPBELL.COM

Rated Lifting Capacities in Pounds

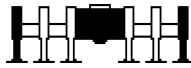

Full

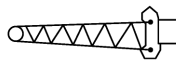

92ft Offset Fly



115,500 lbs



Radius (ft)	Boom Length (ft)											
	Fly Offset											
	44.3				73.5				103.8			
	2°	15°	30°	45°	2°	15°	30°	45°	2°	15°	30°	45°
20	19,800											
25	18,100				17,300							
30	16,700				17,300				15,200			
35	15,500	14,400			17,300				15,200			
40	14,400	13,400			16,300	14,600			15,200			
45	13,400	12,600	11,900		15,300	13,800			15,200	14,700		
50	12,600	11,800	11,200		14,400	13,100			15,200	14,000		
55	11,800	11,200	10,600		13,600	12,400	11,400		15,200	13,400		
60	11,100	10,500	10,000	9,700	12,900	11,800	10,900		14,400	12,800	11,500	
65	10,500	10,000	9,500	9,300	12,200	11,200	10,400	9,800	13,700	12,200	11,000	
70	9,900	9,500	9,100	8,800	11,600	10,700	10,000	9,400	13,100	11,700	10,600	9,800
75	9,400	9,000	8,700	8,400	11,000	10,200	9,500	9,100	12,500	11,300	10,200	9,500
80	8,900	8,600	8,300	8,100	10,500	9,800	9,200	8,700	12,000	10,800	9,900	9,200
85	8,400	8,100	7,800	7,700	10,000	9,400	8,800	8,400	11,500	10,400	9,500	8,900
90	7,900	7,700	7,400	7,300	9,600	9,000	8,500	8,200	11,000	10,000	9,200	8,700
95	7,400	7,200	7,100	7,000	9,200	8,700	8,200	7,900	10,600	9,700	8,900	8,400
100	7,000	6,800	6,700	6,600	8,800	8,300	7,800	7,600	10,200	9,300	8,600	8,200
105	6,500	6,400	6,300	6,300	8,400	7,900	7,500	7,300	9,800	9,000	8,400	8,000
110	6,100	6,000	6,000	6,000	8,000	7,600	7,200	7,000	9,400	8,700	8,100	7,700
115	5,800	5,700	5,700		7,600	7,200	6,900	6,800	9,100	8,400	7,800	7,500
120	5,400	5,400	5,400		7,200	6,900	6,600	6,500	8,800	8,100	7,600	7,300
125	5,100	5,100			6,800	6,500	6,300	6,300	8,400	7,800	7,300	7,100
130					6,500	6,200	6,100	6,100	8,100	7,500	7,100	6,900
135					6,100	6,000	5,800	5,900	7,700	7,200	6,800	6,700
140					5,800	5,700	5,600		7,400	6,900	6,600	6,400
145					5,600	5,500	5,400		7,000	6,700	6,400	6,300
150					5,300	5,200			6,700	6,400	6,200	6,100
155									6,400	6,200	6,000	5,900
160									6,200	5,900	5,800	5,800
165									5,900	5,700	5,600	
170									5,700	5,500	5,400	
175									5,500	5,300	5,300	
180									5,300	5,200		
Min Angle	0.0	0.0	0.0	0.0	14.0	17.0	26.5	26.0	15.5	17.5	25.0	22.5
Max Rad.	127.9	127.5	124.9	120.1	155.0	155.0	150.0	141.2	185.0	185.0	180.0	171.4
Capacity	3,100	3,100	3,400	3,900	0	0	0	0	0	0	0	0

1081120



PORTLAND OFFICE: 503.283.3111
 SEATTLE OFFICE: 206.784.1054
WWW.NESSCAMPBELL.COM

Rated Lifting Capacities in Pounds

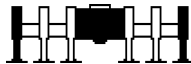

Full

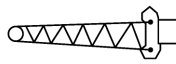

92ft Offset Fly



115,500 lbs



Radius (ft)	Boom Length (ft)											
	Fly Offset											
	119.4				135.4				152.0			
	2°	15°	30°	45°	2°	15°	30°	45°	2°	15°	30°	45°
35	14,900				14,900							
40	14,900				14,900				14,100			
45	14,900				14,900				14,100			
50	14,900	14,500			14,900				14,100			
55	14,900	13,800			14,900	14,200			14,100			
60	14,900	13,300			14,900	13,700			14,100	14,000		
65	14,400	12,700	11,300		14,900	13,100			14,100	13,500		
70	13,800	12,200	10,900		14,500	12,600	11,200		14,100	13,000	11,400	
75	13,200	11,700	10,500	9,700	13,900	12,200	10,800		14,100	12,600	11,100	
80	12,600	11,300	10,200	9,400	13,300	11,700	10,500	9,600	13,900	12,100	10,700	
85	12,100	10,900	9,900	9,200	12,800	11,300	10,100	9,300	13,400	11,700	10,400	9,500
90	11,700	10,500	9,500	8,900	12,300	10,900	9,800	9,100	12,900	11,400	10,100	9,300
95	11,200	10,100	9,300	8,700	11,800	10,600	9,500	8,900	12,500	11,000	9,800	9,100
100	10,800	9,800	9,000	8,400	11,400	10,200	9,300	8,600	12,000	10,700	9,600	8,800
105	10,400	9,500	8,700	8,200	11,000	9,900	9,000	8,400	11,600	10,300	9,300	8,600
110	10,000	9,200	8,500	8,000	10,600	9,600	8,800	8,200	11,200	10,000	9,100	8,400
115	9,700	8,900	8,200	7,800	10,300	9,300	8,500	8,000	10,900	9,700	8,800	8,300
120	9,400	8,600	8,000	7,600	9,900	9,100	8,300	7,800	10,500	9,500	8,600	8,100
125	9,000	8,300	7,700	7,400	9,600	8,800	8,100	7,600	10,200	9,200	8,400	7,900
130	8,700	8,000	7,500	7,200	9,300	8,500	7,900	7,400	9,900	9,000	8,200	7,700
135	8,400	7,800	7,300	7,000	9,000	8,300	7,600	7,300	9,600	8,700	8,000	7,500
140	8,100	7,500	7,100	6,800	8,700	8,000	7,400	7,100	9,300	8,500	7,800	7,300
145	7,800	7,200	6,800	6,600	8,400	7,800	7,200	6,900	9,000	8,200	7,600	7,200
150	7,500	7,000	6,600	6,400	8,100	7,500	7,000	6,800	8,800	8,000	7,400	7,000
155	7,200	6,700	6,400	6,300	7,900	7,300	6,800	6,600	8,500	7,700	7,200	6,900
160	6,900	6,500	6,200	6,100	7,600	7,000	6,600	6,400	8,200	7,500	7,000	6,700
165	6,600	6,200	6,000	6,000	7,300	6,800	6,400	6,300	7,900	7,300	6,800	6,600
170	6,300	6,000	5,800	5,800	7,000	6,500	6,200	6,100	7,700	7,100	6,600	6,400
175	6,100	5,800	5,700		6,700	6,300	6,100	6,000	7,400	6,800	6,400	6,300
180	5,900	5,600	5,500		6,500	6,100	5,900	5,900	7,100	6,600	6,300	6,100
185	5,600	5,500	5,400		6,200	5,900	5,700	5,800	6,900	6,400	6,100	6,000
190	5,400	5,300	5,300		6,000	5,800	5,600		6,600	6,200	6,000	5,900
195	5,300	5,200			5,800	5,600	5,500		6,400	6,000	5,800	5,800
200					5,600	5,400	5,400		6,200	5,900	5,700	5,700
205					5,400	5,300	5,300		6,000	5,700	5,600	
210					5,300	5,200			5,800	5,600	5,400	
215									5,600	5,400	5,300	
220									5,400	5,300	5,300	
225									5,300	5,200		
230									5,100			
Min Angle	16.5	19.0	25.5	19.5	18.0	20.5	26.0	16.5	13.0	22.5	12.5	14.0
Max Rad.	200.0	200.0	195.0	187.0	215.0	215.0	210.0	203.1	233.2	230.0	228.6	219.6
Capacity	0	0	0	0	0	0	0	0	0	0	0	0

1081120



PORTLAND OFFICE: 503.283.3111
 SEATTLE OFFICE: 206.784.1054
 WWW.NESSCAMPBELL.COM

Rated Lifting Capacities in Pounds

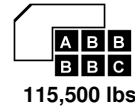
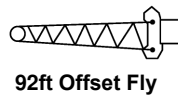
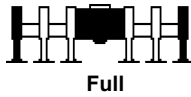

Radius (ft)	Boom Length (ft)			
	Fly Offset			
	168.5			
	2°	15°	30°	45°
45	12,200			
50	12,200			
55	12,200			
60	12,200	12,100		
65	12,200	12,100		
70	12,200	12,100		
75	12,200	12,100		
80	12,200	12,100	10,900	
85	12,200	12,100	10,600	
90	12,200	11,700	10,400	9,400
95	12,200	11,400	10,100	9,200
100	12,200	11,100	9,800	9,000
105	12,200	10,700	9,600	8,800
110	11,800	10,400	9,300	8,600
115	11,400	10,100	9,100	8,400
120	11,100	9,800	8,900	8,300
125	10,700	9,600	8,700	8,100
130	10,400	9,300	8,500	7,900
135	10,100	9,100	8,300	7,800
140	9,800	8,900	8,100	7,600
145	9,500	8,600	7,900	7,400
150	9,300	8,400	7,700	7,300
155	9,000	8,200	7,500	7,100
160	8,800	8,000	7,300	7,000
165	8,500	7,700	7,200	6,800
170	8,200	7,500	7,000	6,700
175	8,000	7,300	6,800	6,500
180	7,700	7,100	6,600	6,400
185	7,500	6,900	6,500	6,300
190	7,200	6,700	6,300	6,200
195	7,000	6,500	6,200	6,000
200	6,800	6,300	6,000	5,900
205	6,500	6,100	5,900	5,800
210	6,300	6,000	5,700	5,700
215	6,100	5,800	5,600	5,700
220	5,800	5,700	5,500	
225	5,300	5,500	5,400	
230	4,900	5,200	5,300	
235	4,500	4,700	4,800	
240	4,100	4,300	4,400	
245	3,800	3,900		
Min Angle	15.5	16.5	22.0	22.0
Max Rad. Capacity	250.0	250.0	245.0	236.2
Capacity	0	0	0	0

1081120



PORTLAND OFFICE: 503.283.3111
 SEATTLE OFFICE: 206.784.1054
WWW.NESSCAMPBELL.COM

Rated Lifting Capacities in Pounds

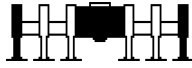

Full

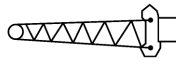

92ft Hydraulic Offset Fly



115,500 lbs



Radius (ft)	Boom Length (ft)											
	Fly Offset											
	44.3			73.5			103.8			134.9		
	2°-15°	15°-30°	30°-45°	2°-15°	15°-30°	30°-45°	2°-15°	15°-30°	30°-45°	2°-15°	15°-30°	30°-45°
20	19,800											
25	18,100			17,300								
30	15,500	15,500		17,300			15,200					
35	14,400	14,400		15,500	15,500		15,200			12,900		
40	13,400	13,400		14,600	14,600		15,200			12,900		
45	12,600	11,900	11,900	13,800	13,800		14,700	14,700		12,900		
50	11,800	11,200	11,200	13,100	11,900	11,900	14,000	14,000		12,800	12,800	
55	11,200	10,600	10,200	12,400	11,400	11,400	13,400	13,400		12,800	12,800	
60	10,500	10,000	9,700	11,800	10,900	10,200	12,800	11,500	11,500	12,800	12,800	
65	10,000	9,500	9,300	11,200	10,400	9,800	12,200	11,000	11,000	12,800	12,800	
70	9,500	9,100	8,800	10,700	10,000	9,400	11,700	10,600	9,800	12,600	11,200	11,200
75	9,000	8,700	8,400	10,200	9,500	9,100	11,300	10,200	9,500	12,200	10,800	10,800
80	8,600	8,300	8,100	9,800	9,200	8,700	10,800	9,900	9,200	11,700	10,500	9,600
85	8,100	7,800	7,700	9,400	8,800	8,400	10,400	9,500	8,900	11,300	10,100	9,300
90	7,700	7,400	7,300	9,000	8,500	8,200	10,000	9,200	8,700	10,900	9,800	9,100
95	7,200	7,100	7,000	8,700	8,200	7,900	9,700	8,900	8,400	10,600	9,500	8,900
100	6,800	6,700	6,600	8,300	7,800	7,600	9,300	8,600	8,200	10,200	9,300	8,600
105	6,400	6,300	6,300	7,900	7,500	7,300	9,000	8,400	8,000	9,900	9,000	8,400
110	6,000	6,000	6,000	7,600	7,200	7,000	8,700	8,100	7,700	9,600	8,800	8,200
115	5,700	5,700	5,700	7,200	6,900	6,800	8,400	7,800	7,500	9,300	8,500	8,000
120	5,400	5,400	5,400	6,900	6,600	6,500	8,100	7,600	7,300	9,000	8,300	7,800
125	5,100	5,100		6,500	6,300	6,300	7,800	7,300	7,100	8,800	8,100	7,600
130				6,200	6,100	6,100	7,500	7,100	6,900	8,500	7,900	7,400
135				6,000	5,800	5,800	7,200	6,800	6,700	8,300	7,600	7,300
140				5,700	5,600	5,600	6,900	6,600	6,400	8,000	7,400	7,100
145				5,500	5,400		6,700	6,400	6,300	7,700	7,200	6,900
150				5,200			6,400	6,200	6,100	7,500	7,000	6,700
155							6,200	6,000	5,900	7,200	6,800	6,600
160							5,900	5,800	5,800	7,000	6,600	6,400
165							5,700	5,600	5,600	6,800	6,400	6,300
170							5,500	5,400	5,400	6,500	6,200	6,100
175							5,300	5,300		6,300	6,000	6,000
180							5,200			6,100	5,900	5,900
185										5,900	5,700	5,700
190										5,500	5,600	5,600
195										5,200	5,400	5,400
200										5,000	5,100	5,100
205										4,700	4,800	
210										4,500		
Min Angle	0.0	0.0	0.0	14.0	26.5	26.0	15.5	25.0	22.5	18.0	26.0	19.5
Max Rad.	127.9	127.5	124.9	155.0	150.0	141.2	185.0	180.0	171.4	215.0	210.0	202.6
Capacity	3,100	3,100	3,400	0	0	0	0	0	0	0	0	0

1082100



PORTLAND OFFICE: 503.283.3111
 SEATTLE OFFICE: 206.784.1054
WWW.NESSCAMPBELL.COM

Rated Lifting Capacities in Pounds

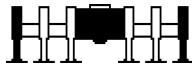

Full

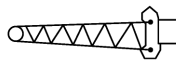

92ft Hydraulic Offset Fly



115,500 lbs



Radius (ft)	Boom Length (ft)								
	Fly Offset								
	167.1			183.6			200.1		
	2°-15°	15°-30°	30°-45°	2°-15°	15°-30°	30°-45°	2°-15°	15°-30°	30°-45°
45	10,400								
50	10,400			9,600					
55	10,300	10,300		9,600			8,200		
60	10,300	10,300		9,500	9,500		8,200		
65	10,300	10,300		9,500	9,500		8,100	8,100	
70	10,300	10,300		9,500	9,500		8,100	8,100	
75	10,300	10,200	10,200	9,500	9,500		8,100	8,100	
80	10,300	10,200	10,200	9,500	9,400	9,400	8,100	8,100	
85	10,300	10,200	9,600	9,500	9,400	9,400	8,100	8,000	8,000
90	10,300	10,200	9,400	9,500	9,400	9,200	8,100	8,000	8,000
95	10,300	10,100	9,200	9,500	9,400	9,200	8,100	8,000	7,800
100	10,300	9,800	9,000	9,500	9,400	9,100	8,100	8,000	7,800
105	10,300	9,500	8,800	9,500	9,400	9,000	8,100	8,000	7,800
110	10,300	9,300	8,600	9,500	9,400	8,800	8,100	8,000	7,800
115	10,100	9,100	8,400	9,500	9,300	8,600	8,100	8,000	7,800
120	9,800	8,900	8,300	9,500	9,100	8,400	8,100	8,000	7,800
125	9,600	8,700	8,100	9,500	8,900	8,300	8,100	8,000	7,800
130	9,300	8,500	7,900	9,500	8,700	8,100	8,100	8,000	7,800
135	9,100	8,300	7,700	9,400	8,500	8,000	8,100	8,000	7,800
140	8,800	8,100	7,600	9,200	8,300	7,800	8,100	8,000	7,800
145	8,600	7,900	7,400	9,000	8,200	7,600	8,100	8,000	7,800
150	8,400	7,700	7,200	8,800	8,000	7,500	8,100	8,000	7,700
155	8,200	7,500	7,100	8,600	7,800	7,300	8,100	8,000	7,500
160	7,800	7,300	7,000	8,300	7,600	7,200	8,100	7,900	7,400
165	7,300	7,100	6,800	8,100	7,400	7,000	8,100	7,700	7,200
170	6,900	7,000	6,700	7,700	7,300	6,900	8,100	7,500	7,100
175	6,500	6,800	6,500	7,300	7,100	6,800	8,000	7,400	7,000
180	6,100	6,400	6,400	6,900	6,900	6,600	7,600	7,200	6,900
185	5,700	6,000	6,200	6,500	6,700	6,500	7,200	7,100	6,700
190	5,300	5,600	5,800	6,100	6,300	6,400	6,800	6,900	6,600
195	5,000	5,200	5,400	5,800	6,000	6,200	6,500	6,700	6,500
200	4,700	4,900	5,100	5,400	5,600	5,800	6,100	6,300	6,400
205	4,400	4,600	4,800	5,100	5,300	5,500	5,800	6,000	6,100
210	4,100	4,300	4,400	4,800	5,000	5,200	5,500	5,600	5,800
215	3,800	4,000	4,100	4,500	4,700	4,900	5,200	5,300	5,500
220	3,500	3,700	3,800	4,200	4,400	4,500	4,900	5,000	5,200
225	3,300	3,400	3,500	4,000	4,100	4,300	4,500	4,800	4,900
230	3,000	3,200	3,200	3,700	3,900	4,000	4,100	4,500	4,600
235	2,800	2,900		3,500	3,600	3,700	3,700	4,100	4,300
240	2,600	2,700		3,200	3,300	3,400	3,300	3,700	4,000
245				3,000	3,100	3,100	2,900	3,300	3,500
250				2,800	2,900	2,800	2,600	2,900	3,100
255				2,600	2,700		2,300	2,500	2,600
260				2,400				2,200	2,200
Min Angle	22.0	19.0	21.5	16.5	22.5	25.5	33.0	33.5	32.5
Max Rad.	245.0	243.7	234.7	265.0	260.0	251.3	260.0	263.3	262.0
Capacity	0	0	0	0	0	0	0	0	0

1082100



PORTLAND OFFICE: 503.283.3111
 SEATTLE OFFICE: 206.784.1054
WWW.NESSCAMPBELL.COM

Rated Lifting Capacities in Pounds

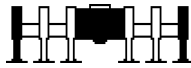

Full

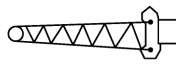

92ft Hydraulic Offset Fly



115,500 lbs



Radius (ft)	Boom Length (ft)											
	Fly Offset											
	44.3			58.9			89.1			120.3		
	2°-15°	15°-30°	30°-45°	2°-15°	15°-30°	30°-45°	2°-15°	15°-30°	30°-45°	2°-15°	15°-30°	30°-45°
20	19,800			19,700								
25	18,100			19,200			18,900					
30	15,500	15,500		16,000	16,000		18,900					
35	14,400	14,400		15,000	15,000		18,300			16,500		
40	13,400	13,400		14,100	14,100		15,100	15,100		16,500		
45	12,600	11,900	11,900	13,300	12,200	12,200	14,300	14,300		16,500		
50	11,800	11,200	11,200	12,500	11,600	11,600	13,600	13,600		14,500	14,500	
55	11,200	10,600	10,200	11,800	11,000	11,000	12,900	11,700	11,700	13,900	13,900	
60	10,500	10,000	9,700	11,200	10,500	10,000	12,300	11,200	11,200	13,300	11,700	11,700
65	10,000	9,500	9,300	10,600	10,000	9,600	11,800	10,700	10,000	12,700	11,300	11,300
70	9,500	9,100	8,800	10,100	9,600	9,200	11,300	10,300	9,700	12,200	10,900	10,000
75	9,000	8,700	8,400	9,600	9,100	8,800	10,800	9,900	9,300	11,800	10,500	9,700
80	8,600	8,300	8,100	9,200	8,700	8,400	10,400	9,600	9,000	11,300	10,200	9,400
85	8,100	7,800	7,700	8,800	8,400	8,100	9,900	9,200	8,700	10,900	9,900	9,200
90	7,700	7,400	7,300	8,400	8,000	7,800	9,600	8,900	8,400	10,500	9,600	8,900
95	7,200	7,100	7,000	8,000	7,700	7,500	9,200	8,600	8,200	10,200	9,300	8,700
100	6,800	6,700	6,600	7,600	7,300	7,200	8,900	8,300	7,900	9,800	9,000	8,400
105	6,400	6,300	6,300	7,200	7,000	6,900	8,500	8,000	7,700	9,500	8,700	8,200
110	6,000	6,000	6,000	6,800	6,600	6,600	8,200	7,700	7,400	9,200	8,500	8,000
115	5,700	5,700	5,700	6,500	6,300	6,300	7,900	7,400	7,200	8,900	8,300	7,800
120	5,400	5,400	5,400	6,200	6,000	6,000	7,600	7,200	7,000	8,600	8,000	7,600
125	5,100	5,100		5,800	5,800	5,800	7,200	6,900	6,700	8,400	7,700	7,400
130				5,600	5,500		6,900	6,600	6,500	8,100	7,500	7,200
135				5,300			6,600	6,400	6,300	7,800	7,300	7,000
140							6,300	6,100	6,100	7,500	7,100	6,800
145							6,100	5,900	5,900	7,300	6,800	6,600
150							5,800	5,700	5,700	7,000	6,600	6,500
155							5,600	5,500	5,500	6,700	6,400	6,300
160							5,400	5,400		6,500	6,200	6,100
165							5,200			6,300	6,000	6,000
170										6,100	5,900	5,800
175										5,900	5,700	5,700
180										5,700	5,500	5,500
185										5,500	5,400	5,400
190										5,300	5,300	
195										5,200		
Min Angle	0.0	0.0	0.0	14.5	28.5	9.5	15.0	26.0	18.5	18.0	26.5	17.0
Max Rad. Capacity	127.9	127.5	124.9	140.0	135.0	126.6	170.0	165.0	156.8	200.0	195.0	188.0
	3,100	3,100	3,400	0	0	0	0	0	0	0	0	0

1082110



PORTLAND OFFICE: 503.283.3111
 SEATTLE OFFICE: 206.784.1054
WWW.NESSCAMPBELL.COM

Rated Lifting Capacities in Pounds

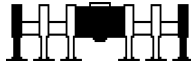

Full

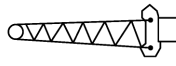

92ft Hydraulic Offset Fly

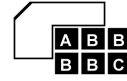

115,500 lbs



Radius (ft)	Boom Length (ft)								
	Fly Offset								
	152.4			169.0			185.5		
	2°-15°	15°-30°	30°-45°	2°-15°	15°-30°	30°-45°	2°-15°	15°-30°	30°-45°
40	13,500								
45	13,500								
50	13,500			12,500			10,700		
55	13,300	13,300		12,500			10,700		
60	13,300	13,300		12,400	12,400		10,700		
65	13,300	13,300		12,400	12,400		10,600	10,600	
70	13,000	11,400	11,400	12,400	12,400		10,600	10,600	
75	12,600	11,100	11,100	12,400	11,300	11,300	10,600	10,600	
80	12,200	10,700	9,800	12,400	10,900	10,900	10,600	10,400	10,400
85	11,800	10,400	9,500	12,100	10,700	10,700	10,600	10,400	10,400
90	11,400	10,100	9,300	11,800	10,400	9,400	10,600	10,400	10,400
95	11,000	9,800	9,100	11,400	10,100	9,200	10,600	10,300	9,400
100	10,700	9,600	8,800	11,100	9,800	9,000	10,600	10,100	9,200
105	10,300	9,300	8,600	10,700	9,600	8,800	10,600	9,800	9,000
110	10,000	9,100	8,400	10,400	9,300	8,600	10,600	9,600	8,800
115	9,800	8,800	8,300	10,100	9,100	8,500	10,500	9,400	8,600
120	9,500	8,600	8,100	9,900	8,900	8,300	10,200	9,100	8,400
125	9,200	8,400	7,900	9,600	8,700	8,100	10,000	8,900	8,300
130	9,000	8,200	7,700	9,300	8,500	7,900	9,700	8,700	8,100
135	8,700	8,000	7,500	9,100	8,300	7,800	9,500	8,500	8,000
140	8,500	7,800	7,400	8,900	8,100	7,600	9,200	8,400	7,800
145	8,200	7,600	7,200	8,700	7,900	7,400	9,000	8,200	7,600
150	8,000	7,400	7,000	8,400	7,700	7,300	8,800	8,000	7,500
155	7,800	7,200	6,900	8,200	7,500	7,100	8,600	7,800	7,300
160	7,500	7,000	6,700	8,000	7,300	7,000	8,400	7,600	7,200
165	7,300	6,800	6,600	7,800	7,200	6,800	8,200	7,500	7,100
170	7,100	6,600	6,400	7,500	7,000	6,700	8,000	7,300	6,900
175	6,800	6,500	6,300	7,300	6,800	6,600	7,700	7,100	6,800
180	6,400	6,300	6,200	7,100	6,600	6,400	7,600	7,000	6,700
185	6,000	6,100	6,000	6,900	6,500	6,300	7,400	6,800	6,500
190	5,700	5,900	5,900	6,500	6,300	6,200	7,200	6,600	6,400
195	5,300	5,500	5,700	6,100	6,200	6,100	6,800	6,500	6,300
200	5,000	5,200	5,400	5,800	6,000	5,900	6,500	6,300	6,200
205	4,700	4,900	5,000	5,500	5,600	5,800	6,200	6,200	6,100
210	4,400	4,600	4,700	5,200	5,300	5,500	5,700	6,000	6,000
215	4,100	4,300	4,300	4,900	5,000	5,100	5,200	5,700	5,800
220	3,900	4,000		4,600	4,700	4,800	4,800	5,200	5,500
225	3,600	3,700		4,300	4,500	4,500	4,300	4,700	5,100
230	3,400			4,100	4,200	4,200	3,900	4,300	4,600
235				3,800	3,900	3,900	3,500	3,900	4,100
240				3,600	3,700		3,100	3,400	3,600
245				3,400			2,800	3,000	3,100
250							2,400	2,700	2,600
255							2,100	2,300	

Min Angle	13.5	15.5	28.5	16.5	23.0	23.0	26.0	25.5	24.0
Max Rad. Capacity	233.9	229.1	220.0	250.0	245.0	236.6	256.7	258.8	253.2
	0	0	0	0	0	0	0	0	0

1082110



PORTLAND OFFICE: 503.283.3111
 SEATTLE OFFICE: 206.784.1054
WWW.NESSCAMPBELL.COM

Rated Lifting Capacities in Pounds

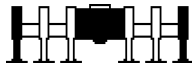

Full

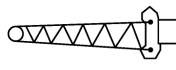

92ft Hydraulic Offset Fly



115,500 lbs



Radius (ft)	Boom Length (ft)											
	Fly Offset											
	44.3			73.5			103.8			119.4		
	2°-15°	15°-30°	30°-45°	2°-15°	15°-30°	30°-45°	2°-15°	15°-30°	30°-45°	2°-15°	15°-30°	30°-45°
20	19,800											
25	18,100			17,300								
30	15,500	15,500		17,300			15,200					
35	14,400	14,400		15,500	15,500		15,200			14,900		
40	13,400	13,400		14,600	14,600		15,200			14,900		
45	12,600	11,900	11,900	13,800	13,800		14,700	14,700		14,900		
50	11,800	11,200	11,200	13,100	11,900	11,900	14,000	14,000		14,500	14,500	
55	11,200	10,600	10,200	12,400	11,400	11,400	13,400	13,400		13,800	13,800	
60	10,500	10,000	9,700	11,800	10,900	10,200	12,800	11,500	11,500	13,300	13,300	
65	10,000	9,500	9,300	11,200	10,400	9,800	12,200	11,000	11,000	12,700	11,300	11,300
70	9,500	9,100	8,800	10,700	10,000	9,400	11,700	10,600	9,800	12,200	10,900	10,900
75	9,000	8,700	8,400	10,200	9,500	9,100	11,300	10,200	9,500	11,700	10,500	9,700
80	8,600	8,300	8,100	9,800	9,200	8,700	10,800	9,900	9,200	11,300	10,200	9,400
85	8,100	7,800	7,700	9,400	8,800	8,400	10,400	9,500	8,900	10,900	9,900	9,200
90	7,700	7,400	7,300	9,000	8,500	8,200	10,000	9,200	8,700	10,500	9,500	8,900
95	7,200	7,100	7,000	8,700	8,200	7,900	9,700	8,900	8,400	10,100	9,300	8,700
100	6,800	6,700	6,600	8,300	7,800	7,600	9,300	8,600	8,200	9,800	9,000	8,400
105	6,400	6,300	6,300	7,900	7,500	7,300	9,000	8,400	8,000	9,500	8,700	8,200
110	6,000	6,000	6,000	7,600	7,200	7,000	8,700	8,100	7,700	9,200	8,500	8,000
115	5,700	5,700	5,700	7,200	6,900	6,800	8,400	7,800	7,500	8,900	8,200	7,800
120	5,400	5,400	5,400	6,900	6,600	6,500	8,100	7,600	7,300	8,600	8,000	7,600
125	5,100	5,100		6,500	6,300	6,300	7,800	7,300	7,100	8,300	7,700	7,400
130				6,200	6,100	6,100	7,500	7,100	6,900	8,000	7,500	7,200
135				6,000	5,800	5,800	7,200	6,800	6,700	7,800	7,300	7,000
140				5,700	5,600	5,600	6,900	6,600	6,400	7,500	7,100	6,800
145				5,500	5,400		6,700	6,400	6,300	7,200	6,800	6,600
150				5,200			6,400	6,200	6,100	7,000	6,600	6,400
155							6,200	6,000	5,900	6,700	6,400	6,300
160							5,900	5,800	5,800	6,500	6,200	6,100
165							5,700	5,600	5,600	6,200	6,000	6,000
170							5,500	5,400	5,400	6,000	5,800	5,800
175							5,300	5,300		5,800	5,700	5,700
180							5,200			5,600	5,500	5,500
185										5,500	5,400	5,400
190										5,300	5,300	
195										5,200		
Min Angle	0.0	0.0	0.0	14.0	26.5	26.0	15.5	25.0	22.5	16.5	25.5	19.5
Max Rad. Capacity	127.9	127.5	124.9	155.0	150.0	141.2	185.0	180.0	171.4	200.0	195.0	187.0
	3,100	3,100	3,400	0	0	0	0	0	0	0	0	0

1082120



PORTLAND OFFICE: 503.283.3111
 SEATTLE OFFICE: 206.784.1054
WWW.NESSCAMPBELL.COM

Rated Lifting Capacities in Pounds

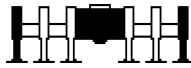

Full

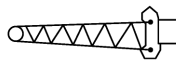

92ft Hydraulic Offset Fly

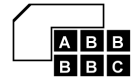

115,500 lbs



Radius (ft)	Boom Length (ft)								
	Fly Offset								
	135.4			152.0			168.5		
	2°-15°	15°-30°	30°-45°	2°-15°	15°-30°	30°-45°	2°-15°	15°-30°	30°-45°
35	14,900								
40	14,900			14,100					
45	14,900			14,100			12,200		
50	14,900			14,100			12,200		
55	14,200	14,200		14,000	14,000		12,200		
60	13,700	13,700		14,000	14,000		12,100	12,100	
65	13,100	11,500	11,500	13,500	13,500		12,100	12,100	
70	12,600	11,200	11,200	13,000	11,400	11,400	12,100	12,100	
75	12,200	10,800	9,900	12,600	11,100	11,100	12,100	11,300	11,300
80	11,700	10,500	9,600	12,100	10,700	9,800	12,100	10,900	10,900
85	11,300	10,100	9,300	11,700	10,400	9,500	12,100	10,600	9,700
90	10,900	9,800	9,100	11,400	10,100	9,300	11,700	10,400	9,400
95	10,600	9,500	8,900	11,000	9,800	9,100	11,400	10,100	9,200
100	10,200	9,300	8,600	10,700	9,600	8,800	11,100	9,800	9,000
105	9,900	9,000	8,400	10,300	9,300	8,600	10,700	9,600	8,800
110	9,600	8,800	8,200	10,000	9,100	8,400	10,400	9,300	8,600
115	9,300	8,500	8,000	9,700	8,800	8,300	10,100	9,100	8,400
120	9,100	8,300	7,800	9,500	8,600	8,100	9,800	8,900	8,300
125	8,800	8,100	7,600	9,200	8,400	7,900	9,600	8,700	8,100
130	8,500	7,900	7,400	9,000	8,200	7,700	9,300	8,500	7,900
135	8,300	7,600	7,300	8,700	8,000	7,500	9,100	8,300	7,800
140	8,000	7,400	7,100	8,500	7,800	7,300	8,900	8,100	7,600
145	7,800	7,200	6,900	8,200	7,600	7,200	8,600	7,900	7,400
150	7,500	7,000	6,800	8,000	7,400	7,000	8,400	7,700	7,300
155	7,300	6,800	6,600	7,700	7,200	6,900	8,200	7,500	7,100
160	7,000	6,600	6,400	7,500	7,000	6,700	8,000	7,300	7,000
165	6,800	6,400	6,300	7,300	6,800	6,600	7,700	7,200	6,800
170	6,500	6,200	6,100	7,100	6,600	6,400	7,500	7,000	6,700
175	6,300	6,100	6,000	6,800	6,400	6,300	7,300	6,800	6,500
180	6,100	5,900	5,900	6,600	6,300	6,100	7,100	6,600	6,400
185	5,900	5,700	5,700	6,400	6,100	6,000	6,900	6,500	6,300
190	5,800	5,600	5,600	6,200	6,000	5,900	6,700	6,300	6,200
195	5,600	5,500	5,500	6,000	5,800	5,800	6,500	6,200	6,000
200	5,400	5,400	5,400	5,900	5,700	5,700	6,300	6,000	5,900
205	5,300	5,300		5,700	5,600	5,600	6,100	5,900	5,800
210	5,200			5,600	5,400	5,400	6,000	5,700	5,700
215				5,400	5,300	5,300	5,800	5,600	5,600
220				5,300	5,300		5,700	5,500	5,500
225				5,200	5,200		5,300	5,400	5,400
230							4,900	5,200	5,200
235							4,500	4,700	4,600
240							4,100	4,300	
245							3,800		
Min Angle	18.0	26.0	16.5	22.5	12.5	14.0	15.5	22.0	22.0
Max Rad. Capacity	215.0	210.0	203.1	230.0	228.6	219.6	250.0	245.0	236.2
	0	0	0	0	0	0	0	0	0

1082120



PORTLAND OFFICE: 503.283.3111
 SEATTLE OFFICE: 206.784.1054
WWW.NESSCAMPBELL.COM

Rated Lifting Capacities in Pounds

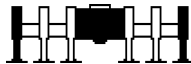

Full

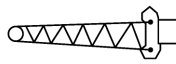

117ft Offset Fly

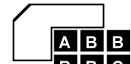

115,500 lbs



Radius (ft)	Boom Length (ft)											
	Fly Offset											
	44.3				73.5				103.8			
	2°	15°	30°	45°	2°	15°	30°	45°	2°	15°	30°	45°
25	15,800											
30	14,500				14,800							
35	13,300				14,800				13,100			
40	12,300	11,900			13,800				13,100			
45	11,400	11,000			12,900	12,000			13,100			
50	10,600	10,300	10,000		12,100	11,300			13,100			
55	9,900	9,600	9,400		11,300	10,700			12,600	11,500		
60	9,200	9,000	8,800		10,600	10,000	9,500		11,900	10,900		
65	8,600	8,400	8,300	8,200	10,000	9,500	9,000		11,300	10,400		
70	8,100	7,900	7,800	7,800	9,400	9,000	8,600	8,300	10,700	9,900	9,200	
75	7,600	7,500	7,400	7,300	8,900	8,500	8,200	7,900	10,100	9,400	8,800	
80	7,000	6,900	6,900	6,900	8,400	8,100	7,800	7,600	9,600	9,000	8,400	8,000
85	6,600	6,500	6,400	6,400	8,000	7,700	7,400	7,200	9,100	8,500	8,000	7,700
90	6,100	6,100	6,000	6,000	7,500	7,200	7,000	6,800	8,700	8,200	7,700	7,400
95	5,600	5,600	5,600	5,700	7,100	6,800	6,600	6,500	8,300	7,800	7,400	7,100
100	5,200	5,200	5,300	5,300	6,700	6,400	6,200	6,100	7,900	7,500	7,000	6,800
105	4,800	4,900	4,900	4,900	6,300	6,100	5,900	5,800	7,500	7,100	6,700	6,500
110	4,500	4,500	4,600	4,600	5,900	5,700	5,600	5,500	7,100	6,700	6,400	6,200
115	4,200	4,200	4,200	4,300	5,500	5,400	5,300	5,200	6,800	6,400	6,100	5,900
120	3,900	3,900	3,900	4,000	5,200	5,000	5,000	4,900	6,400	6,100	5,800	5,700
125	3,600	3,600	3,700	3,700	4,800	4,700	4,700	4,700	6,100	5,800	5,600	5,400
130	3,300	3,400	3,400	3,500	4,500	4,500	4,400	4,400	5,700	5,500	5,300	5,200
135	3,100	3,100	3,200		4,300	4,200	4,200	4,200	5,400	5,200	5,000	4,900
140	2,900	2,900	2,900		4,000	3,900	3,900	3,900	5,100	4,900	4,800	4,700
145	2,600	2,700			3,700	3,700	3,700	3,700	4,800	4,700	4,500	4,500
150	2,500	2,500			3,500	3,500	3,500	3,500	4,600	4,400	4,300	4,300
155					3,300	3,300	3,300	3,300	4,300	4,200	4,100	4,100
160					3,100	3,100	3,100		4,100	4,000	3,900	3,900
165					2,900	2,900	2,900		3,900	3,800	3,700	3,700
170					2,700	2,700	2,700		3,700	3,600	3,500	3,600
175					2,600	2,600			3,500	3,400	3,400	3,400
180									3,300	3,200	3,200	3,200
185									3,100	3,100	3,100	
190									3,000	2,900	2,900	
195									2,800	2,800	2,800	
200									2,700	2,600	2,700	
205									2,500	2,500		
Min Angle	0.0	0.0	0.0	0.0	13.5	16.0	24.0	29.5	15.0	17.0	23.5	27.5
Max Rad. Capacity	152.9	152.4	149.4	144.0	180.0	180.0	175.0	166.2	210.0	210.0	205.0	196.4
	2,400	2,400	2,500	2,700	0	0	0	0	0	0	0	0

1081130



PORTLAND OFFICE: 503.283.3111
 SEATTLE OFFICE: 206.784.1054
WWW.NESSCAMPBELL.COM

Rated Lifting Capacities in Pounds

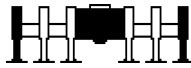

Full

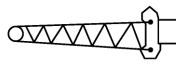

117ft Offset Fly



115,500 lbs



Radius (ft)	Boom Length (ft)											
	Fly Offset											
	134.9				167.1				183.6			
	2°	15°	30°	45°	2°	15°	30°	45°	2°	15°	30°	45°
45	11,000											
50	11,000				8,600							
55	11,000				8,600							
60	11,000				8,600				7,900			
65	11,000	10,900			8,600				7,900			
70	11,000	10,600			8,600	8,500			7,900			
75	11,000	10,200			8,600	8,500			7,900	7,800		
80	10,700	9,700	8,900		8,600	8,500			7,900	7,800		
85	10,200	9,300	8,600		8,600	8,500			7,900	7,800		
90	9,800	8,900	8,300	7,800	8,600	8,500	8,400		7,900	7,800		
95	9,300	8,600	8,000	7,500	8,600	8,500	8,400		7,900	7,800	7,700	
100	8,900	8,200	7,700	7,300	8,600	8,500	8,200	7,600	7,900	7,800	7,700	
105	8,600	7,900	7,400	7,000	8,600	8,500	7,900	7,400	7,900	7,800	7,700	7,500
110	8,200	7,600	7,100	6,700	8,600	8,300	7,600	7,200	7,900	7,800	7,700	7,400
115	7,900	7,300	6,800	6,500	8,600	8,000	7,400	6,900	7,900	7,800	7,600	7,200
120	7,500	7,000	6,500	6,200	8,500	7,800	7,100	6,700	7,900	7,800	7,400	6,900
125	7,200	6,700	6,300	6,000	8,200	7,500	6,900	6,500	7,900	7,800	7,200	6,700
130	6,900	6,400	6,000	5,800	7,900	7,200	6,600	6,300	7,900	7,600	6,900	6,500
135	6,600	6,100	5,800	5,600	7,600	6,900	6,400	6,100	7,900	7,300	6,700	6,300
140	6,300	5,900	5,500	5,400	7,300	6,700	6,200	5,900	7,700	7,000	6,500	6,100
145	6,000	5,600	5,300	5,100	7,000	6,400	6,000	5,700	7,400	6,800	6,200	5,900
150	5,700	5,300	5,100	4,900	6,700	6,200	5,700	5,500	7,100	6,500	6,000	5,700
155	5,400	5,100	4,900	4,700	6,400	5,900	5,500	5,300	6,900	6,300	5,800	5,600
160	5,100	4,900	4,700	4,500	6,200	5,700	5,300	5,100	6,600	6,100	5,600	5,400
165	4,900	4,600	4,500	4,400	5,900	5,500	5,100	4,900	6,400	5,900	5,400	5,200
170	4,600	4,400	4,300	4,200	5,600	5,200	4,900	4,800	6,100	5,600	5,200	5,000
175	4,400	4,200	4,100	4,000	5,400	5,000	4,700	4,600	5,900	5,400	5,100	4,900
180	4,200	4,000	3,900	3,900	5,100	4,800	4,600	4,400	5,600	5,200	4,900	4,700
185	4,000	3,900	3,800	3,700	4,800	4,600	4,400	4,300	5,400	5,000	4,700	4,600
190	3,800	3,700	3,600	3,600	4,500	4,400	4,200	4,100	5,100	4,800	4,500	4,400
195	3,700	3,500	3,500	3,500	4,100	4,300	4,100	4,000	4,800	4,600	4,400	4,300
200	3,500	3,400	3,300	3,300	3,800	4,100	3,900	3,900	4,500	4,500	4,200	4,100
205	3,300	3,200	3,200	3,200	3,500	3,800	3,800	3,700	4,100	4,300	4,100	4,000
210	3,200	3,100	3,100		3,200	3,500	3,700	3,600	3,800	4,100	3,900	3,900
215	3,000	3,000	2,900		2,900	3,200	3,400	3,500	3,600	3,800	3,800	3,800
220	2,900	2,800	2,800		2,700	2,900	3,100	3,200	3,300	3,500	3,700	3,600
225	2,700	2,700	2,700		2,400	2,600	2,800	2,900	3,000	3,200	3,400	3,500
230	2,500	2,600	2,600		2,200	2,400	2,500	2,600	2,800	3,000	3,200	3,200
235	2,400	2,400				2,100	2,300	2,300	2,500	2,700	2,900	3,000
240									2,300	2,500	2,600	2,700
245									2,100	2,200	2,400	2,400
250											2,100	2,200
Min Angle	18.0	20.0	25.0	26.0	41.0	41.5	42.0	41.5	42.5	43.0	43.5	43.0
Max Rad. Capacity	240.0	240.0	235.0	227.6	233.3	237.5	240.0	240.0	246.7	250.0	252.5	253.3
	0	0	0	0	0	0	0	0	0	0	0	0

1081130



PORTLAND OFFICE: 503.283.3111
 SEATTLE OFFICE: 206.784.1054
WWW.NESSCAMPBELL.COM

Rated Lifting Capacities in Pounds

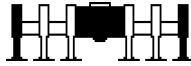

Full

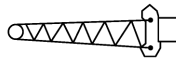

117ft Offset Fly

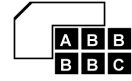

115,500 lbs



Radius (ft)	Boom Length (ft)			
	Fly Offset			
	200.1			
	2°	15°	30°	45°
60	6,700			
65	6,700			
70	6,700			
75	6,700			
80	6,700	6,600		
85	6,700	6,600		
90	6,700	6,600		
95	6,700	6,600	6,400	
100	6,700	6,600	6,400	
105	6,700	6,600	6,400	
110	6,700	6,600	6,400	6,300
115	6,700	6,600	6,400	6,300
120	6,700	6,600	6,400	6,300
125	6,700	6,600	6,400	6,300
130	6,700	6,600	6,400	6,300
135	6,700	6,600	6,400	6,300
140	6,700	6,600	6,400	6,300
145	6,700	6,600	6,400	6,100
150	6,700	6,600	6,300	5,900
155	6,700	6,600	6,100	5,800
160	6,700	6,400	5,900	5,600
165	6,700	6,200	5,700	5,400
170	6,500	6,000	5,500	5,300
175	6,300	5,800	5,400	5,100
180	6,100	5,600	5,200	4,900
185	5,800	5,400	5,000	4,800
190	5,600	5,200	4,800	4,600
195	5,400	5,000	4,700	4,500
200	5,100	4,800	4,500	4,400
205	4,700	4,600	4,400	4,200
210	4,400	4,500	4,200	4,100
215	4,100	4,300	4,100	4,000
220	3,800	4,100	3,900	3,900
225	3,600	3,800	3,800	3,800
230	3,300	3,500	3,700	3,600
235	3,100	3,300	3,500	3,500
240	2,800	3,000	3,200	3,300
245	2,600	2,800	2,900	3,000
250	2,400	2,600	2,700	2,800
255		2,300	2,500	2,500
260			2,200	2,300
Min Angle	45.0	45.5	46.0	45.0
Max Rad. Capacity	255.0	260.0	263.3	263.8
Capacity	0	0	0	0

1081130



PORTLAND OFFICE: 503.283.3111
 SEATTLE OFFICE: 206.784.1054
WWW.NESSCAMPBELL.COM

Rated Lifting Capacities in Pounds

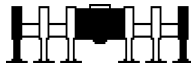

Full

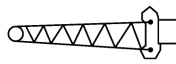

117ft Offset Fly



115,500 lbs



Radius (ft)	Boom Length (ft)											
	Fly Offset											
	44.3				58.9				89.1			
	2°	15°	30°	45°	2°	15°	30°	45°	2°	15°	30°	45°
25	15,800				16,400							
30	14,500				15,300							
35	13,300				14,100				15,600			
40	12,300	11,900			13,100	12,400			14,500			
45	11,400	11,000			12,200	11,600			13,600			
50	10,600	10,300	10,000		11,400	10,800			12,800	11,800		
55	9,900	9,600	9,400		10,600	10,200	9,800		12,000	11,100		
60	9,200	9,000	8,800		10,000	9,600	9,200		11,300	10,500		
65	8,600	8,400	8,300	8,200	9,400	9,000	8,700	8,500	10,700	10,000	9,400	
70	8,100	7,900	7,800	7,800	8,800	8,500	8,200	8,100	10,100	9,500	8,900	
75	7,600	7,500	7,400	7,300	8,300	8,000	7,800	7,700	9,600	9,000	8,500	8,200
80	7,000	6,900	6,900	6,900	7,800	7,600	7,400	7,300	9,100	8,500	8,100	7,800
85	6,600	6,500	6,400	6,400	7,300	7,100	6,900	6,900	8,600	8,100	7,700	7,500
90	6,100	6,100	6,000	6,000	6,800	6,700	6,500	6,500	8,200	7,800	7,400	7,200
95	5,600	5,600	5,600	5,700	6,400	6,300	6,200	6,100	7,800	7,400	7,000	6,800
100	5,200	5,200	5,300	5,300	6,000	5,900	5,800	5,800	7,300	7,000	6,700	6,500
105	4,800	4,900	4,900	4,900	5,600	5,500	5,400	5,400	6,900	6,600	6,300	6,200
110	4,500	4,500	4,600	4,600	5,200	5,100	5,100	5,100	6,600	6,300	6,000	5,900
115	4,200	4,200	4,200	4,300	4,800	4,800	4,800	4,800	6,200	6,000	5,700	5,600
120	3,900	3,900	3,900	4,000	4,500	4,500	4,500	4,500	5,800	5,600	5,400	5,300
125	3,600	3,600	3,700	3,700	4,200	4,200	4,200	4,200	5,500	5,300	5,200	5,100
130	3,300	3,400	3,400	3,500	3,900	3,900	3,900	4,000	5,200	5,000	4,900	4,800
135	3,100	3,100	3,200		3,700	3,700	3,700	3,700	4,900	4,700	4,600	4,600
140	2,900	2,900	2,900		3,400	3,400	3,500	3,500	4,600	4,500	4,400	4,400
145	2,600	2,700			3,200	3,200	3,200		4,300	4,200	4,200	4,100
150	2,500	2,500			3,000	3,000	3,000		4,100	4,000	3,900	3,900
155					2,800	2,800	2,800		3,800	3,800	3,700	3,700
160					2,600	2,600			3,600	3,600	3,500	3,500
165									3,400	3,400	3,400	3,400
170									3,200	3,200	3,200	
175									3,000	3,000	3,000	
180									2,900	2,900	2,900	
185									2,700	2,700	2,700	
190									2,600	2,600		
Min Angle	0.0	0.0	0.0	0.0	14.0	17.0	25.5	30.0	14.5	17.0	24.0	27.0
Max Rad. Capacity	152.9	152.4	149.4	144.0	165.0	165.0	160.0	151.6	195.0	195.0	190.0	181.8
	2,400	2,400	2,500	2,700	0	0	0	0	0	0	0	0

1081140



PORTLAND OFFICE: 503.283.3111
 SEATTLE OFFICE: 206.784.1054
WWW.NESSCAMPBELL.COM

Rated Lifting Capacities in Pounds

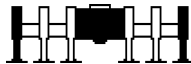

Full

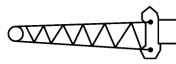

117ft Offset Fly



115,500 lbs



Radius (ft)	Boom Length (ft)											
	Fly Offset											
	120.3				152.4				169.0			
	2°	15°	30°	45°	2°	15°	30°	45°	2°	15°	30°	45°
40	14,400											
45	14,400											
50	14,000				11,500							
55	13,200				11,500				10,600			
60	12,500	11,300			11,500				10,600			
65	11,900	10,800			11,500	11,400			10,600			
70	11,300	10,300	9,500		11,500	11,000			10,600			
75	10,700	9,800	9,100		11,500	10,600			10,600	10,500		
80	10,200	9,400	8,700	8,200	11,300	10,100	9,200		10,600	10,500		
85	9,700	9,000	8,300	7,900	10,800	9,700	8,900		10,600	10,100		
90	9,300	8,600	8,000	7,600	10,300	9,300	8,500	8,000	10,600	9,700	8,800	
95	8,900	8,200	7,700	7,400	9,900	9,000	8,200	7,700	10,400	9,300	8,500	
100	8,500	7,900	7,400	7,100	9,500	8,600	8,000	7,500	9,900	9,000	8,200	7,700
105	8,100	7,600	7,100	6,800	9,100	8,300	7,700	7,300	9,600	8,700	7,900	7,400
110	7,800	7,200	6,800	6,500	8,700	8,000	7,400	7,000	9,200	8,400	7,700	7,200
115	7,400	6,900	6,500	6,200	8,400	7,700	7,100	6,700	8,900	8,100	7,400	7,000
120	7,000	6,600	6,200	6,000	8,100	7,400	6,900	6,500	8,500	7,800	7,200	6,700
125	6,700	6,300	6,000	5,800	7,800	7,100	6,600	6,300	8,200	7,500	6,900	6,500
130	6,400	6,000	5,700	5,500	7,400	6,800	6,400	6,100	7,900	7,200	6,700	6,300
135	6,100	5,700	5,400	5,300	7,100	6,600	6,100	5,900	7,600	7,000	6,400	6,100
140	5,700	5,400	5,200	5,100	6,800	6,300	5,900	5,700	7,300	6,700	6,200	5,900
145	5,400	5,200	5,000	4,800	6,500	6,100	5,700	5,500	7,000	6,400	6,000	5,700
150	5,200	4,900	4,700	4,600	6,300	5,800	5,500	5,300	6,700	6,200	5,800	5,500
155	4,900	4,700	4,500	4,400	6,000	5,600	5,200	5,100	6,500	6,000	5,600	5,300
160	4,700	4,500	4,300	4,300	5,700	5,300	5,000	4,900	6,200	5,700	5,400	5,100
165	4,400	4,200	4,100	4,100	5,400	5,100	4,800	4,700	5,900	5,500	5,200	5,000
170	4,200	4,000	3,900	3,900	5,200	4,900	4,600	4,500	5,700	5,300	5,000	4,800
175	4,000	3,900	3,800	3,700	4,900	4,700	4,500	4,400	5,400	5,100	4,800	4,600
180	3,800	3,700	3,600	3,600	4,700	4,500	4,300	4,200	5,200	4,900	4,600	4,500
185	3,600	3,500	3,400	3,400	4,500	4,300	4,100	4,000	5,000	4,700	4,400	4,300
190	3,400	3,300	3,300	3,300	4,300	4,100	4,000	3,900	4,800	4,500	4,300	4,200
195	3,300	3,200	3,200	3,200	4,100	3,900	3,800	3,800	4,600	4,300	4,100	4,000
200	3,100	3,000	3,000		3,900	3,800	3,700	3,600	4,400	4,100	4,000	3,900
205	2,900	2,900	2,900		3,800	3,600	3,500	3,500	4,200	4,000	3,800	3,800
210	2,800	2,800	2,800		3,500	3,500	3,400	3,400	4,000	3,800	3,700	3,700
215	2,700	2,600	2,700		3,300	3,300	3,300	3,300	3,800	3,700	3,600	3,500
220	2,500	2,500			3,000	3,200	3,100	3,200	3,600	3,500	3,400	3,400
225					2,700	2,900	3,000		3,400	3,400	3,300	3,300
230					2,500	2,700	2,800		3,100	3,300	3,200	3,200
235					2,300	2,400	2,500		2,900	3,100	3,100	3,100
240						2,200	2,300		2,600	2,800	2,900	
245									2,400	2,600	2,700	
250									2,200	2,300	2,400	
255										2,100	2,200	
Min Angle	17.5	19.5	25.0	24.5	31.0	30.5	31.0	29.0	32.0	33.0	32.0	31.0
Max Rad.	225.0	225.0	220.0	213.0	240.0	245.0	245.0	243.3	255.0	257.5	260.0	257.5
Capacity	0	0	0	0	0	0	0	0	0	0	0	0

1081140



PORTLAND OFFICE: 503.283.3111
 SEATTLE OFFICE: 206.784.1054
WWW.NESSCAMPBELL.COM

Rated Lifting Capacities in Pounds

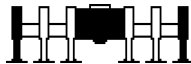

Full

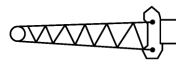

117ft Offset Fly

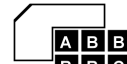

115,500 lbs



Radius (ft)	Boom Length (ft)			
	Fly Offset			
	185.5			
	2°	15°	30°	45°
60	9,000			
65	9,000			
70	9,000			
75	9,000			
80	9,000	9,000		
85	9,000	9,000		
90	9,000	9,000		
95	9,000	9,000	8,700	
100	9,000	9,000	8,400	
105	9,000	9,000	8,200	7,600
110	9,000	8,700	7,900	7,400
115	9,000	8,400	7,700	7,200
120	9,000	8,100	7,400	6,900
125	8,600	7,900	7,200	6,700
130	8,300	7,600	6,900	6,500
135	8,100	7,300	6,700	6,300
140	7,800	7,100	6,500	6,100
145	7,500	6,800	6,300	5,900
150	7,200	6,600	6,100	5,800
155	6,900	6,300	5,900	5,600
160	6,700	6,100	5,700	5,400
165	6,400	5,900	5,500	5,200
170	6,200	5,700	5,300	5,100
175	5,900	5,500	5,100	4,900
180	5,700	5,200	4,900	4,700
185	5,400	5,000	4,700	4,600
190	5,200	4,900	4,600	4,400
195	5,000	4,700	4,400	4,300
200	4,800	4,500	4,300	4,200
205	4,600	4,300	4,100	4,000
210	4,400	4,200	4,000	3,900
215	4,200	4,000	3,800	3,800
220	4,100	3,900	3,700	3,700
225	3,900	3,700	3,600	3,600
230	3,700	3,600	3,500	3,400
235	3,400	3,500	3,400	3,300
240	3,000	3,300	3,200	3,200
245	2,600	3,000	3,100	3,200
250	2,200	2,600	2,900	2,900
255		2,200	2,500	
260			2,100	
Min Angle	40.0	40.5	40.5	40.5
Max Rad. Capacity	253.3	258.3	261.3	260.0
	0	0	0	0

1081140



PORTLAND OFFICE: 503.283.3111
 SEATTLE OFFICE: 206.784.1054
WWW.NESSCAMPBELL.COM

Rated Lifting Capacities in Pounds

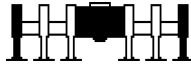

Full

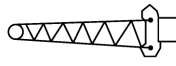

117ft Offset Fly

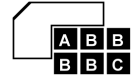

115,500 lbs



Radius (ft)	Boom Length (ft)											
	Fly Offset											
	44.3				73.5				103.8			
	2°	15°	30°	45°	2°	15°	30°	45°	2°	15°	30°	45°
25	15,800											
30	14,500				14,800							
35	13,300				14,800				13,100			
40	12,300	11,900			13,800				13,100			
45	11,400	11,000			12,900	12,000			13,100			
50	10,600	10,300	10,000		12,100	11,300			13,100			
55	9,900	9,600	9,400		11,300	10,700			12,600	11,500		
60	9,200	9,000	8,800		10,600	10,000	9,500		11,900	10,900		
65	8,600	8,400	8,300	8,200	10,000	9,500	9,000		11,300	10,400		
70	8,100	7,900	7,800	7,800	9,400	9,000	8,600	8,300	10,700	9,900	9,200	
75	7,600	7,500	7,400	7,300	8,900	8,500	8,200	7,900	10,100	9,400	8,800	
80	7,000	6,900	6,900	6,900	8,400	8,100	7,800	7,600	9,600	9,000	8,400	8,000
85	6,600	6,500	6,400	6,400	8,000	7,700	7,400	7,200	9,100	8,500	8,000	7,700
90	6,100	6,100	6,000	6,000	7,500	7,200	7,000	6,800	8,700	8,200	7,700	7,400
95	5,600	5,600	5,600	5,700	7,100	6,800	6,600	6,500	8,300	7,800	7,400	7,100
100	5,200	5,200	5,300	5,300	6,700	6,400	6,200	6,100	7,900	7,500	7,000	6,800
105	4,800	4,900	4,900	4,900	6,300	6,100	5,900	5,800	7,500	7,100	6,700	6,500
110	4,500	4,500	4,600	4,600	5,900	5,700	5,600	5,500	7,100	6,700	6,400	6,200
115	4,200	4,200	4,200	4,300	5,500	5,400	5,300	5,200	6,800	6,400	6,100	5,900
120	3,900	3,900	3,900	4,000	5,200	5,000	5,000	4,900	6,400	6,100	5,800	5,700
125	3,600	3,600	3,700	3,700	4,800	4,700	4,700	4,700	6,100	5,800	5,600	5,400
130	3,300	3,400	3,400	3,500	4,500	4,500	4,400	4,400	5,700	5,500	5,300	5,200
135	3,100	3,100	3,200		4,300	4,200	4,200	4,200	5,400	5,200	5,000	4,900
140	2,900	2,900	2,900		4,000	3,900	3,900	3,900	5,100	4,900	4,800	4,700
145	2,600	2,700			3,700	3,700	3,700	3,700	4,800	4,700	4,500	4,500
150	2,500	2,500			3,500	3,500	3,500	3,500	4,600	4,400	4,300	4,300
155					3,300	3,300	3,300	3,300	4,300	4,200	4,100	4,100
160					3,100	3,100	3,100		4,100	4,000	3,900	3,900
165					2,900	2,900	2,900		3,900	3,800	3,700	3,700
170					2,700	2,700	2,700		3,700	3,600	3,500	3,600
175					2,600	2,600			3,500	3,400	3,400	3,400
180									3,300	3,200	3,200	3,200
185									3,100	3,100	3,100	
190									3,000	2,900	2,900	
195									2,800	2,800	2,800	
200									2,700	2,600	2,700	
205									2,500	2,500		
Min Angle	0.0	0.0	0.0	0.0	13.5	16.0	24.0	29.5	15.0	17.0	23.5	27.5
Max Rad. Capacity	152.9	152.4	149.4	144.0	180.0	180.0	175.0	166.2	210.0	210.0	205.0	196.4
	2,400	2,400	2,500	2,700	0	0	0	0	0	0	0	0

1081150



PORTLAND OFFICE: 503.283.3111
 SEATTLE OFFICE: 206.784.1054
WWW.NESSCAMPBELL.COM

Rated Lifting Capacities in Pounds

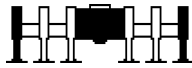

Full

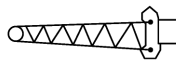

117ft Offset Fly



115,500 lbs



Radius (ft)	Boom Length (ft)											
	Fly Offset											
	119.4				135.4				152.0			
	2°	15°	30°	45°	2°	15°	30°	45°	2°	15°	30°	45°
40	12,800											
45	12,800				12,700							
50	12,800				12,700				11,900			
55	12,800				12,700				11,900			
60	12,500	11,300			12,700	11,700			11,900			
65	11,800	10,800			12,400	11,100			11,900	11,500		
70	11,200	10,300			11,800	10,700			11,900	11,000		
75	10,700	9,800	9,100		11,200	10,200	9,300		11,800	10,500		
80	10,200	9,400	8,700		10,700	9,800	8,900		11,200	10,100	9,200	
85	9,700	9,000	8,300	7,900	10,200	9,300	8,600	8,100	10,800	9,700	8,900	
90	9,300	8,600	8,000	7,600	9,800	9,000	8,300	7,800	10,300	9,300	8,500	8,000
95	8,800	8,200	7,700	7,300	9,400	8,600	8,000	7,500	9,900	9,000	8,200	7,700
100	8,400	7,900	7,400	7,000	9,000	8,300	7,700	7,300	9,500	8,600	8,000	7,500
105	8,100	7,600	7,100	6,800	8,600	7,900	7,400	7,000	9,100	8,300	7,700	7,300
110	7,700	7,200	6,800	6,500	8,200	7,600	7,100	6,700	8,700	8,000	7,400	7,000
115	7,400	6,900	6,500	6,200	7,900	7,300	6,800	6,500	8,400	7,700	7,100	6,700
120	7,000	6,600	6,200	6,000	7,600	7,000	6,500	6,200	8,100	7,400	6,900	6,500
125	6,700	6,300	5,900	5,700	7,200	6,700	6,300	6,000	7,800	7,100	6,600	6,300
130	6,300	6,000	5,700	5,500	6,900	6,400	6,000	5,800	7,400	6,800	6,400	6,100
135	6,000	5,700	5,400	5,300	6,600	6,100	5,800	5,600	7,100	6,600	6,100	5,800
140	5,700	5,400	5,200	5,000	6,300	5,900	5,600	5,400	6,800	6,300	5,900	5,600
145	5,400	5,100	4,900	4,800	6,000	5,600	5,300	5,100	6,500	6,000	5,700	5,400
150	5,100	4,900	4,700	4,600	5,700	5,400	5,100	4,900	6,200	5,800	5,400	5,200
155	4,900	4,700	4,500	4,400	5,400	5,100	4,900	4,700	6,000	5,500	5,200	5,000
160	4,600	4,400	4,300	4,200	5,100	4,900	4,700	4,600	5,700	5,300	5,000	4,900
165	4,400	4,200	4,100	4,100	4,900	4,700	4,500	4,400	5,400	5,100	4,800	4,700
170	4,200	4,000	3,900	3,900	4,700	4,400	4,300	4,200	5,200	4,900	4,600	4,500
175	4,000	3,800	3,700	3,700	4,400	4,200	4,100	4,000	4,900	4,700	4,400	4,300
180	3,800	3,700	3,600	3,600	4,200	4,100	3,900	3,900	4,700	4,500	4,300	4,200
185	3,600	3,500	3,400	3,400	4,000	3,900	3,800	3,700	4,500	4,300	4,100	4,000
190	3,400	3,300	3,300	3,300	3,800	3,700	3,600	3,600	4,300	4,100	3,900	3,900
195	3,200	3,200	3,100	3,200	3,700	3,500	3,500	3,500	4,100	3,900	3,800	3,800
200	3,100	3,000	3,000		3,500	3,400	3,300	3,300	3,900	3,800	3,700	3,600
205	2,900	2,900	2,900		3,300	3,200	3,200	3,200	3,800	3,600	3,500	3,500
210	2,800	2,700	2,700		3,200	3,100	3,100		3,600	3,500	3,400	3,400
215	2,600	2,600	2,600		3,000	3,000	2,900		3,400	3,300	3,300	3,300
220	2,500	2,500			2,900	2,800	2,800		3,300	3,200	3,100	3,200
225					2,800	2,700	2,700		3,100	3,100	3,000	
230					2,600	2,600	2,600		3,000	2,900	2,900	
235					2,500	2,500			2,900	2,800	2,800	
240									2,800	2,700	2,700	
245									2,600	2,600	2,600	
250									2,500	2,500		
255									2,400			
Min Angle	16.5	18.5	24.0	26.0	18.0	20.0	25.0	24.0	18.5	22.0	18.5	22.0
Max Rad.	225.0	225.0	220.0	212.0	240.0	240.0	235.0	228.1	255.8	255.0	253.6	244.6
Capacity	0	0	0	0	0	0	0	0	0	0	0	0

1081150



PORTLAND OFFICE: 503.283.3111
 SEATTLE OFFICE: 206.784.1054
WWW.NESSCAMPBELL.COM

Rated Lifting Capacities in Pounds

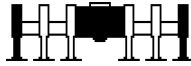

Full

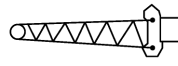

117ft Offset Fly

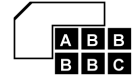

115,500 lbs



Radius (ft)	Boom Length (ft)			
	Fly Offset			
	168.5			
	2°	15°	30°	45°
50	10,200			
55	10,200			
60	10,200			
65	10,200			
70	10,200	10,100		
75	10,200	10,100		
80	10,200	10,100		
85	10,200	10,100	9,100	
90	10,200	9,700	8,800	
95	10,200	9,300	8,500	7,900
100	9,900	9,000	8,200	7,700
105	9,500	8,700	7,900	7,400
110	9,200	8,300	7,700	7,200
115	8,800	8,100	7,400	7,000
120	8,500	7,800	7,200	6,700
125	8,200	7,500	6,900	6,500
130	7,900	7,200	6,700	6,300
135	7,600	7,000	6,400	6,100
140	7,300	6,700	6,200	5,900
145	7,000	6,400	6,000	5,700
150	6,700	6,200	5,800	5,500
155	6,500	6,000	5,600	5,300
160	6,200	5,700	5,400	5,100
165	5,900	5,500	5,200	5,000
170	5,700	5,300	5,000	4,800
175	5,400	5,100	4,800	4,600
180	5,200	4,900	4,600	4,500
185	5,000	4,700	4,400	4,300
190	4,800	4,500	4,300	4,200
195	4,500	4,300	4,100	4,000
200	4,400	4,100	4,000	3,900
205	4,200	4,000	3,800	3,800
210	4,000	3,800	3,700	3,600
215	3,800	3,700	3,500	3,500
220	3,700	3,500	3,400	3,400
225	3,500	3,400	3,300	3,300
230	3,400	3,300	3,200	3,200
235	3,200	3,100	3,100	3,100
240	3,100	3,000	3,000	
245	3,000	2,900	2,900	
250	2,900	2,800	2,800	
255	2,800	2,700	2,700	
260	2,600	2,600	2,600	
265	2,300	2,400	2,400	
270		2,100		
Min Angle	22.0	21.0	22.0	28.5
Max Rad. Capacity	270.0	271.7	270.0	260.0
Capacity	0	0	0	0

1081150



PORTLAND OFFICE: 503.283.3111
 SEATTLE OFFICE: 206.784.1054
WWW.NESSCAMPBELL.COM

Rated Lifting Capacities in Pounds

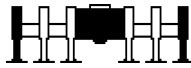

Full

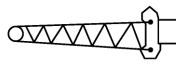

117ft Hydraulic Offset Fly



115,500 lbs



Radius (ft)	Boom Length (ft)											
	Fly Offset											
	44.3			73.5			103.8			134.9		
	2°-15°	15°-30°	30°-45°	2°-15°	15°-30°	30°-45°	2°-15°	15°-30°	30°-45°	2°-15°	15°-30°	30°-45°
25	15,800											
30	14,500			14,800								
35	12,800	12,800		14,800			13,100					
40	11,900	11,900		12,900	12,900		13,100					
45	11,000	11,000		12,000	12,000		13,100			11,000		
50	10,300	10,000	10,000	11,300	11,300		12,200	12,200		11,000		
55	9,600	9,400	9,400	10,700	10,100	10,100	11,500	11,500		11,000		
60	9,000	8,800	8,700	10,000	9,500	9,500	10,900	10,900		10,900	10,900	
65	8,400	8,300	8,200	9,500	9,000	8,700	10,400	9,600	9,600	10,900	10,900	
70	7,900	7,800	7,800	9,000	8,600	8,300	9,900	9,200	9,200	10,600	10,600	
75	7,500	7,400	7,300	8,500	8,200	7,900	9,400	8,800	8,400	10,200	9,300	9,300
80	6,900	6,900	6,900	8,100	7,800	7,600	9,000	8,400	8,000	9,700	8,900	8,900
85	6,500	6,400	6,400	7,700	7,400	7,200	8,500	8,000	7,700	9,300	8,600	8,100
90	6,100	6,000	6,000	7,200	7,000	6,800	8,200	7,700	7,400	8,900	8,300	7,800
95	5,600	5,600	5,600	6,800	6,600	6,500	7,800	7,400	7,100	8,600	8,000	7,500
100	5,200	5,200	5,300	6,400	6,200	6,100	7,500	7,000	6,800	8,200	7,700	7,300
105	4,800	4,900	4,900	6,100	5,900	5,800	7,100	6,700	6,500	7,900	7,400	7,000
110	4,500	4,500	4,600	5,700	5,600	5,500	6,700	6,400	6,200	7,600	7,100	6,700
115	4,200	4,200	4,200	5,400	5,300	5,200	6,400	6,100	5,900	7,300	6,800	6,500
120	3,900	3,900	3,900	5,000	5,000	4,900	6,100	5,800	5,700	7,000	6,500	6,200
125	3,600	3,600	3,700	4,700	4,700	4,700	5,800	5,600	5,400	6,700	6,300	6,000
130	3,300	3,400	3,400	4,500	4,400	4,400	5,500	5,300	5,200	6,400	6,000	5,800
135	3,100	3,100	3,200	4,200	4,200	4,200	5,200	5,000	4,900	6,100	5,800	5,600
140	2,900	2,900	2,900	3,900	3,900	3,900	4,900	4,800	4,700	5,900	5,500	5,400
145	2,600	2,700		3,700	3,700	3,700	4,700	4,500	4,500	5,600	5,300	5,100
150	2,500	2,500		3,500	3,500	3,500	4,400	4,300	4,300	5,300	5,100	4,900
155				3,300	3,300	3,300	4,200	4,100	4,100	5,100	4,900	4,700
160				3,100	3,100	3,100	4,000	3,900	3,900	4,900	4,700	4,500
165				2,900	2,900	2,900	3,800	3,700	3,700	4,600	4,500	4,400
170				2,700	2,700		3,600	3,500	3,500	4,400	4,300	4,200
175				2,600			3,400	3,400	3,400	4,200	4,100	4,000
180							3,200	3,200	3,200	4,000	3,900	3,900
185							3,100	3,100	3,100	3,900	3,800	3,700
190							2,900	2,900	2,900	3,700	3,600	3,600
195							2,800	2,800	2,800	3,500	3,500	3,500
200							2,600	2,600		3,400	3,300	3,300
205							2,500			3,200	3,200	3,200
210										3,100	3,100	3,100
215										3,000	2,900	2,900
220										2,800	2,800	2,800
225										2,700	2,700	2,700
230										2,500	2,600	
235										2,400		
Min Angle	0.0	0.0	0.0	13.5	24.0	29.5	15.0	23.5	27.5	18.0	25.0	26.0
Max Rad. Capacity	152.9	152.4	149.4	180.0	175.0	166.2	210.0	205.0	196.4	240.0	235.0	227.6
	2,400	2,400	2,500	0	0	0	0	0	0	0	0	0

1082130



PORTLAND OFFICE: 503.283.3111
 SEATTLE OFFICE: 206.784.1054
WWW.NESSCAMPBELL.COM

Rated Lifting Capacities in Pounds

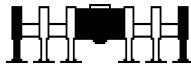

Full

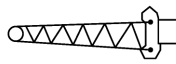

117ft Hydraulic Offset Fly

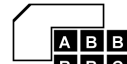

115,500 lbs



Radius (ft)	Boom Length (ft)								
	Fly Offset								
	167.1			183.6			200.1		
	2°-15°	15°-30°	30°-45°	2°-15°	15°-30°	30°-45°	2°-15°	15°-30°	30°-45°
50	8,600								
55	8,600								
60	8,600			7,900			6,700		
65	8,500	8,500		7,900			6,700		
70	8,500	8,500		7,800	7,800		6,600	6,600	
75	8,500	8,500		7,800	7,800		6,600	6,600	
80	8,500	8,500		7,800	7,800		6,600	6,600	
85	8,500	8,400	8,400	7,800	7,600	7,600	6,600	6,600	
90	8,500	8,400	8,400	7,800	7,600	7,600	6,600	6,600	
95	8,500	8,400	7,900	7,800	7,600	7,600	6,600	6,400	6,400
100	8,500	8,200	7,600	7,800	7,600	7,400	6,600	6,400	6,400
105	8,500	7,900	7,400	7,800	7,600	7,400	6,600	6,400	6,200
110	8,300	7,600	7,200	7,800	7,600	7,400	6,600	6,400	6,200
115	8,000	7,400	6,900	7,800	7,600	7,200	6,600	6,400	6,200
120	7,800	7,100	6,700	7,800	7,400	6,900	6,600	6,400	6,200
125	7,500	6,900	6,500	7,800	7,200	6,700	6,600	6,400	6,200
130	7,200	6,600	6,300	7,600	6,900	6,500	6,600	6,400	6,200
135	6,900	6,400	6,100	7,300	6,700	6,300	6,600	6,400	6,200
140	6,700	6,200	5,900	7,000	6,500	6,100	6,600	6,400	6,200
145	6,400	6,000	5,700	6,800	6,200	5,900	6,600	6,400	6,100
150	6,200	5,700	5,500	6,500	6,000	5,700	6,600	6,300	5,900
155	5,900	5,500	5,300	6,300	5,800	5,600	6,600	6,100	5,800
160	5,700	5,300	5,100	6,100	5,600	5,400	6,400	5,900	5,600
165	5,500	5,100	4,900	5,900	5,400	5,200	6,200	5,700	5,400
170	5,200	4,900	4,800	5,600	5,200	5,000	6,000	5,500	5,300
175	5,000	4,700	4,600	5,400	5,100	4,900	5,800	5,400	5,100
180	4,800	4,600	4,400	5,200	4,900	4,700	5,600	5,200	4,900
185	4,600	4,400	4,300	5,000	4,700	4,600	5,400	5,000	4,800
190	4,400	4,200	4,100	4,800	4,500	4,400	5,200	4,800	4,600
195	4,100	4,100	4,000	4,600	4,400	4,300	5,000	4,700	4,500
200	3,800	3,900	3,900	4,500	4,200	4,100	4,800	4,500	4,400
205	3,500	3,800	3,700	4,100	4,100	4,000	4,600	4,400	4,200
210	3,200	3,500	3,600	3,800	3,900	3,900	4,400	4,200	4,100
215	2,900	3,200	3,400	3,600	3,800	3,800	4,100	4,100	4,000
220	2,700	2,900	3,100	3,300	3,500	3,600	3,800	3,900	3,900
225	2,400	2,600	2,800	3,000	3,200	3,400	3,600	3,800	3,800
230	2,200	2,400	2,500	2,800	3,000	3,200	3,300	3,500	3,600
235		2,100	2,300	2,500	2,700	2,900	3,100	3,300	3,500
240				2,300	2,500	2,600	2,800	3,000	3,200
245				2,100	2,200	2,400	2,600	2,800	2,900
250						2,100	2,400	2,600	2,700
255								2,300	2,500
260									2,200
Min Angle	41.0	41.5	41.5	42.5	43.0	43.5	45.0	45.5	46.0
Max Rad. Capacity	233.3	237.5	240.0	246.7	250.0	252.5	255.0	260.0	263.3
	0	0	0	0	0	0	0	0	0

1082130



PORTLAND OFFICE: 503.283.3111
 SEATTLE OFFICE: 206.784.1054
WWW.NESSCAMPBELL.COM

Rated Lifting Capacities in Pounds

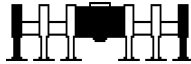

Full

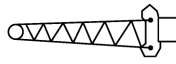

117ft Hydraulic Offset Fly

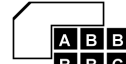

115,500 lbs



Radius (ft)	Boom Length (ft)											
	Fly Offset											
	44.3			58.9			89.1			120.3		
	2°-15°	15°-30°	30°-45°	2°-15°	15°-30°	30°-45°	2°-15°	15°-30°	30°-45°	2°-15°	15°-30°	30°-45°
25	15,800			16,400								
30	14,500			15,300								
35	12,800	12,800		13,300	13,300		15,600					
40	11,900	11,900		12,400	12,400		14,500			14,400		
45	11,000	11,000		11,600	11,600		12,500	12,500		14,400		
50	10,300	10,000	10,000	10,800	10,400	10,400	11,800	11,800		14,000		
55	9,600	9,400	9,400	10,200	9,800	9,800	11,100	11,100		11,900	11,900	
60	9,000	8,800	8,700	9,600	9,200	9,200	10,500	9,800	9,800	11,300	11,300	
65	8,400	8,300	8,200	9,000	8,700	8,500	10,000	9,400	9,400	10,800	9,900	9,900
70	7,900	7,800	7,800	8,500	8,200	8,100	9,500	8,900	8,500	10,300	9,500	9,500
75	7,500	7,400	7,300	8,000	7,800	7,700	9,000	8,500	8,200	9,800	9,100	9,100
80	6,900	6,900	6,900	7,600	7,400	7,300	8,500	8,100	7,800	9,400	8,700	8,200
85	6,500	6,400	6,400	7,100	6,900	6,900	8,100	7,700	7,500	9,000	8,300	7,900
90	6,100	6,000	6,000	6,700	6,500	6,500	7,800	7,400	7,200	8,600	8,000	7,600
95	5,600	5,600	5,600	6,300	6,200	6,100	7,400	7,000	6,800	8,200	7,700	7,400
100	5,200	5,200	5,300	5,900	5,800	5,800	7,000	6,700	6,500	7,900	7,400	7,100
105	4,800	4,900	4,900	5,500	5,400	5,400	6,600	6,300	6,200	7,600	7,100	6,800
110	4,500	4,500	4,600	5,100	5,100	5,100	6,300	6,000	5,900	7,200	6,800	6,500
115	4,200	4,200	4,200	4,800	4,800	4,800	6,000	5,700	5,600	6,900	6,500	6,200
120	3,900	3,900	3,900	4,500	4,500	4,500	5,600	5,400	5,300	6,600	6,200	6,000
125	3,600	3,600	3,700	4,200	4,200	4,200	5,300	5,200	5,100	6,300	6,000	5,800
130	3,300	3,400	3,400	3,900	3,900	3,900	5,000	4,900	4,800	6,000	5,700	5,500
135	3,100	3,100	3,200	3,700	3,700	3,700	4,700	4,600	4,600	5,700	5,400	5,300
140	2,900	2,900	2,900	3,400	3,400	3,500	4,500	4,400	4,400	5,400	5,200	5,100
145	2,600	2,700		3,200	3,200	3,200	4,200	4,200	4,100	5,200	5,000	4,800
150	2,500	2,500		3,000	3,000	3,000	4,000	3,900	3,900	4,900	4,700	4,600
155				2,800	2,800		3,800	3,700	3,700	4,700	4,500	4,400
160				2,600			3,600	3,500	3,500	4,500	4,300	4,300
165							3,400	3,400	3,400	4,200	4,100	4,100
170							3,200	3,200	3,200	4,000	3,900	3,900
175							3,000	3,000	3,000	3,900	3,800	3,700
180							2,900	2,900	2,900	3,700	3,600	3,600
185							2,700	2,700		3,500	3,400	3,400
190							2,600			3,300	3,300	3,300
195										3,200	3,200	3,200
200										3,000	3,000	3,000
205										2,900	2,900	2,900
210										2,800	2,800	2,800
215										2,600	2,600	
220										2,500		
Min Angle	0.0	0.0	0.0	14.0	25.5	30.0	14.5	24.0	27.0	17.5	25.0	24.5
Max Rad.	152.9	152.4	149.4	165.0	160.0	151.6	195.0	190.0	181.8	225.0	220.0	213.0
Capacity	2,400	2,400	2,500	0	0	0	0	0	0	0	0	0

1082140



PORTLAND OFFICE: 503.283.3111
 SEATTLE OFFICE: 206.784.1054
WWW.NESSCAMPBELL.COM