



BOOM TRUCK
21 TONS
NATIONAL SERIES 800C

BOOM LENGTHS:
25FT TO 80FT

JIB LENGTHS:
24FT TO 43FT

JIB OFFSETS:
0



NOTES:

National Series 800C Booms and Jibs

Boom and Jib Combination

Note: An angling jib (8FJ15A) is available *for Models 869C and 880C*

869C: 27-69 ft. three section



869C: 27-69 ft. three section



8FJ27: 27 ft. single section



869C: 27-69 ft. three section



8FJ48M: 21-48 ft. manual pullout



880C: 24-80 ft. four section



880C: 24-80 ft. four section



8FJ24: 24 1/2 ft. single section



880C: 24-80 ft. four section



8FJ43M: 21-43 ft. manual pull-out



Reaches to 133 feet

The Series 800C is available in two basic models:
1. 869C with a 27-69 foot three-section boom. This

model reaches to a height of 122 feet when equipped with a 48-foot jib. It reaches to a height of 79 feet hydraulically.

2. 880C with a 24.5-80 foot four-section boom. This model reaches to a height of 133 feet when equipped with the 43-foot

jib. It reaches to a height of 90 feet hydraulically. Both models are available with the optional jibs shown in the chart above.

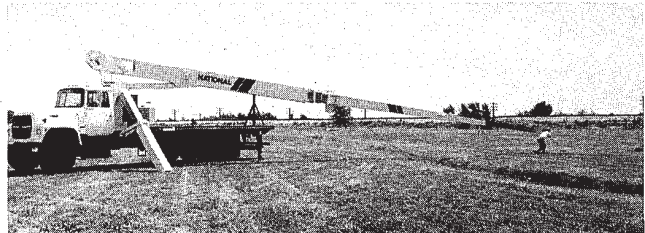
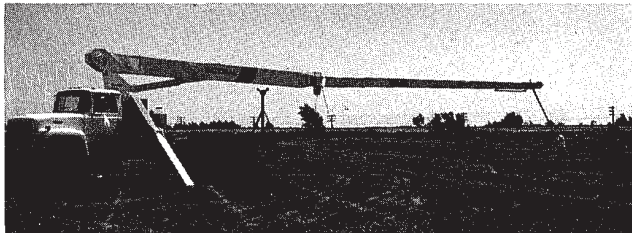
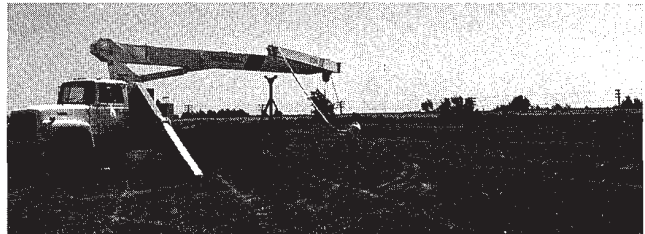
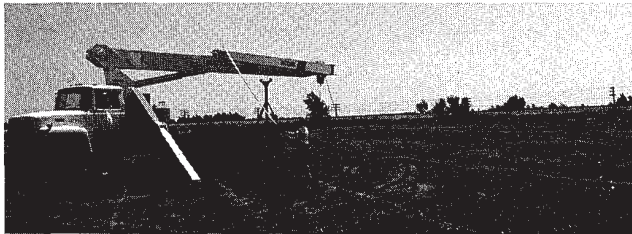







This sequence of photos shows how a National jib *folds* out into a *working position*.



PORTLAND OFFICE: 503.283.3111
SEATTLE OFFICE: 206.784.1054
WWW.NESSCAMPBELL.COM

National Series 800C Winch Data

NATIONAL SERIES 800C WINCH DATA			1 Part Line	2 Part Line	3 Part Line	4 Part Line	5 Part Line	6 Part Line
CAUTION								
<ul style="list-style-type: none"> Do not deadhead lineblock against boom tip when extending boom. Keep at least three wraps of loadline on drum at all times. Use only 9/16" diameter rotation resistant cable with 38,500 pounds breaking strength on this machine. Maximum capacity with "Burst-of-Speed" is 3,000 pounds. 								
Winch	Cable Supplied	Average Breaking Strength	Lift and Speed	Lift and Speed	Lift and Speed	Lift and Speed	Lift and Speed	Lift and Speed
Standard Planetary Winch	9/16" diameter rotation resistant 19 x 7 IWRC	38,500 lbs.	7,700 lbs. 164 fpm	15,400 lbs. 82 fpm	23,100 lbs. 55 fpm	30,800 lbs. 41 fpm	38,500 lbs. 33 fpm	42,000 lbs. 27 fpm
	Optional 9/16" diameter 6 x 25 IWRC	29,750 lbs.	7,700 lbs. 164 fpm	15,400 lbs. 82 fpm	23,100 lbs. 55 fpm	30,800 lbs. 41 fpm	38,500 lbs. 33 fpm	42,000 lbs. 27 fpm
with "Burst-of-Speed" Feature	Same as corresponding cable data shown above		3,000 lbs. 265 fpm	6,000 lbs. 133 fpm	9,000 lbs. 88 fpm	12,000 lbs. 66 fpm	15,000 lbs. 53 fpm	18,000 lbs. 44 fpm

All winch pulls and speeds are shown on the fourth layer. Winch pulls would increase on the first, second and third layers. Winch line pulls would decrease on the first, second and third layers. Winch line pulls may be limited by the winch capacity or the cable safety factor. These are shown below:

Winch	Bare Drum Pull	Allowable Cable Pull
With standard rotation resistant rope	10,000 pounds	7,700 pounds
With optional 6 x 25 IWRC rope	10,000 pounds	8,400 pounds

<p>Do not operate crane booms, jib extensions, any accessories, or loads within 10-feet (3m) of live power lines or other conductors of electricity</p>	<p>1. Load ratings shown on the following load rating charts are maximum allowable loads with the outriggers properly extended on a firm, level surface and the crane leveled and mounted on a factory-recommended truck.</p>	<p>2. Always level the crane with the level indicator located on the crane frame. 3. The operator must reduce loads to allow for factors such as wind, ground conditions, operating speeds, and the effect of freely suspended loads.</p>	<p>4. Overloading this crane may cause structural collapse or instability. 5. Weights of any accessories attached to the boom or loadline must be deducted from the load chart capacities. 6. Do not exceed jib capacities at any reduced boom lengths.</p>
--	---	---	---

Dimensional Specification

Series	Retracted Length	Extended Length	G	Dry* Wt/Lb	With Oil* Wt/Lb
880C	24.5 ft.	80 ft.	87 in.	17,750*	18,500*
869C	27 ft.	69 ft.	90 in.	17,400*	18,150*

*Weight includes all items except ASH (600#).

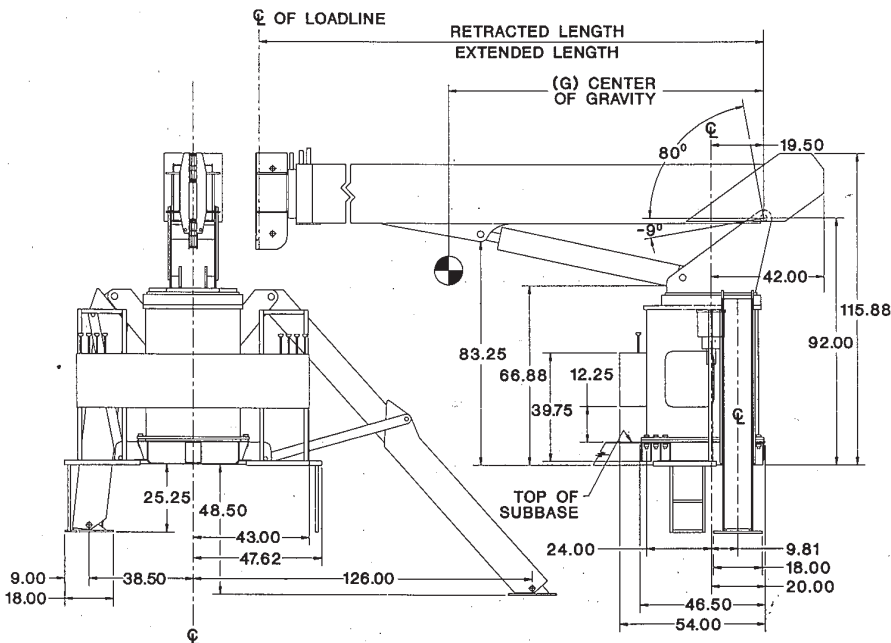
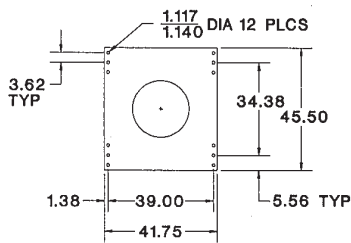

Cranes are tough when they are in use, but they can be severely damaged during travel from job to job. The only way a crane can be protected from this type of wear and damage is a strong, solid boom rest.

Boom Rests

- Add years to the life of your crane
- Reduce stress on the crane frame
- Protect rotation gear from transit damage
- Remove stress from truck frame
- Spread crane load more evenly
- Reduce maintenance and downtime

In addition, boom rests are required to provide a positive way to immobilize your crane for transit.

National Crane supplies two heavy-duty boom rests for strong, sure protection of your crane. There is a quality National boom rest to fit your mounting configuration. All National cranes must be fitted with a boom rest. All factory mounted cranes will be supplied with a boom rest.

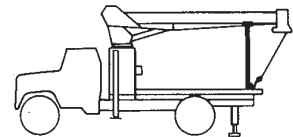

*Horizontal rear bed mount
for greater load space*

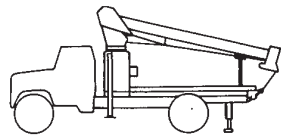

*Low-profile rear bed mount
for lower center of gravity*

LOAD RATINGS SERIES 880C WITH NO JIB

LOAD RADIUS (FEET)	LOADED BOOM ANGLE	24.5 FT BOOM LBS	LOADED BOOM ANGLE	36 FT BOOM LBS	LOADED BOOM ANGLE	47 FT BOOM LBS	LOADED BOOM ANGLE	58 FT BOOM LBS	LOADED BOOM ANGLE	69 FT BOOM LBS	LOADED BOOM ANGLE	80 FT BOOM LBS
5	77.5	42000										
8	70	29500										
10	64.5	24500	73.5	22400	78	20800						
12	58.5	21200	70	19200	75.5	17700	78.5	16400				
14	52.5	18500	66.5	6800	73	15600	76.5	14300	79.5	13300		
16	46	16200	63	14900	70	13700	74.5	12700	77.5	11800	79.5	11400
20	29	12500	55	12100	64.5	11200	70	10300	74	9700	76.5	9200
25			44	9700	57.5	9100	65	8400	69.5	7700	72.5	7300
30			31	7600	50	7500	59	6900	65	6400	68.5	6050
35					41	6300	53	5900	60	5500	64.5	5100
40					30	5100	46.5	5000	55	4700	60.5	4400
45							38.5	4300	49.5	4100	56.5	3850
50							29	3500	43.5	3500	52	3360
55							13	2400	37	3000	47	2900
60									29	2500	41.5	2500
65									17	1800	35.5	2100
70											28	1700
75											18	1200

DEDUCTS

- DOWNHAUL WEIGHT = 150
- ONE SHEAVE BLOCK = 200
- TWO SHEAVE BLOCK = 355
- THREE SHEAVE BLOCK = 530



PORTLAND OFFICE: 503.283.3111
 SEATTLE OFFICE: 206.784.1054
WWW.NESSCAMPBELL.COM

LOAD RATINGS SERIES 880C WITH 24.5 FT JIB

LOAD RADIUS (FEET)	LOADED BOOM ANGLE	24.5 FT BOOM LBS	LOADED BOOM ANGLE	36 FT BOOM LBS	LOADED BOOM ANGLE	47 FT BOOM LBS	LOADED BOOM ANGLE	58 FT BOOM LBS	LOADED BOOM ANGLE	69 FT BOOM LBS	LOADED BOOM ANGLE	80 FT BOOM LBS	LOAD RADIUS (FEET)	LOADED BOOM ANGLE	24.5 FT JIB (LBS)
5	77.5	42000											20	79.5	5600
8	70	29200											25	77	4900
10	64.5	24200	73.5	22200	78	20600							30	74	4300
12	58.5	20900	70	19000	75.5	17500	78.5	16200					35	71	3650
14	52.5	18200	66.5	16600	73	15300	76.5	14100	79.5	13200			40	68	3100
16	46	15900	63	14700	70	13500	74.5	12500	77.5	11700	79.5	11300	45	65	2600
20	29	12200	55	11900	64.5	11000	70	10100	74	9800	76.5	9100	50	62	2200
25			44	9500	57.5	8900	65	8200	69.5	7600	72.5	7200	55	59	1900
30			31	7400	50	7300	59	6700	65	6300	68.5	5950	60	55.5	1600
35					41	6100	53	5700	60	5400	64.5	5000	65	52	1350
40					30	4900	46.5	4800	55	4600	60.5	4300	70	48.5	1100
45							38.5	4100	49.5	4000	56.5	3750	75	45	850
50							29	3300	43.5	3400	52	3250	80	41	650
55							13	2200	37	2900	47	2800	85		
60									29	2400	41.5	2400	90		
65									17	1700	35.5	2000			
70											28	1600			
75											18	1100			

DEDUCTS

DOWNHAUL WEIGHT = 150
 ONE SHEAVE BLOCK = 200
 TWO SHEAVE BLOCK = 355
 THREE SHEAVE BLOCK = 530



PORTLAND OFFICE: 503.283.3111
 SEATTLE OFFICE: 206.784.1054
WWW.NESSCAMPBELL.COM

LOAD RATINGS SERIES 880C WITH 43 FT JIB

LOAD RADIUS (FEET)	LOADED BOOM ANGLE	24.5 FT BOOM LBS	LOADED BOOM ANGLE	36 FT BOOM LBS	LOADED BOOM ANGLE	47 FT BOOM LBS	LOADED BOOM ANGLE	58 FT BOOM LBS	LOADED BOOM ANGLE	69 FT BOOM LBS	LOADED BOOM ANGLE	80 FT BOOM LBS	LOAD RADIUS (FEET)	LOADED BOOM ANGLE	43 FT JIB (LBS)
5	77.5	42000											20		
8	70	29200											25	79	3350
10	64.5	24200	73.5	22200	78	20600							30	77	3000
12	58.5	20900	70	19000	75.5	17500	78.5	16200					35	75	2650
14	52.5	18200	66.5	16600	73	15300	76.5	14100	79.5	13200			40	72.5	240
16	46	15900	63	14700	70	13500	74.5	12500	77.5	11700	79.5	11300	45	70	2200
20	29	12200	55	11900	64.5	11000	70	10100	74	9800	76.5	9100	50	67.5	2000
25			44	9500	57.5	8900	65	8200	69.5	7600	72.5	7200	55	65	1800
30			31	7400	50	7300	59	6700	65	6300	68.5	5950	60	62.5	1600
35					41	6100	53	5700	60	5400	64.5	5000	65	60	1400
40					30	4900	46.5	4800	55	4600	60.5	4300	70	57	1200
45							38.5	4100	49.5	4000	56.5	3750	75	54	1000
50							29	3300	43.5	3400	52	3250	80	51	850
55							13	2200	37	2900	47	2800	85	48	700
60									29	2400	41.5	2400	90	44	550
65									17	1700	35.5	2000			
70											28	1600			
75											18	1100			

DEDUCTS

DOWNHAUL WEIGHT = 150
 ONE SHEAVE BLOCK = 200
 TWO SHEAVE BLOCK = 355
 THREE SHEAVE BLOCK = 530



PORTLAND OFFICE: 503.283.3111
 SEATTLE OFFICE: 206.784.1054
WWW.NESSCAMPBELL.COM

National Series 800C Load Rating Charts

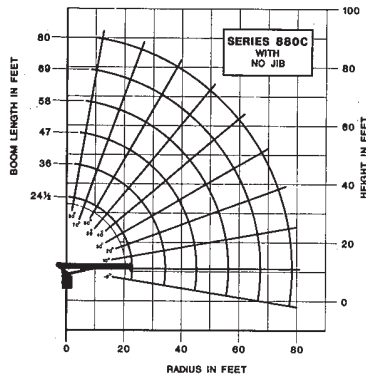

LOAD RATINGS												
LOAD RADIUS (FEET)	LOADED BOOM ANGLE	24½ FT BOOM (LBS)	36 FT BOOM (LBS)	47 FT BOOM (LBS)	58 FT BOOM (LBS)	69 FT BOOM (LBS)	80 FT BOOM (LBS)	91 FT BOOM (LBS)	102 FT BOOM (LBS)	113 FT BOOM (LBS)		
5	77.5	42,000										
8	70	29,500										
10	64.5	24,500	73.5	22,400	78	20,800						
12	58.5	21,200	70	19,200	75.5	17,700	78.5	16,400				
14	52.5	18,200	66.5	16,800	73	15,600	76.5	14,300	79.5	13,300		
16	46	16,200	63	14,900	70	13,700	74.5	12,700	77.5	11,800		
20	29	12,500	55	12,100	64.5	11,200	70	10,300	74	9,700		
25			44	9,700	57.5	9,100	65	8,400	69.5	7,700		
30			31	7,800	50	7,500	59	6,900	65	6,400		
35					41	6,300	53	5,900	60	5,600		
40					30	5,100	46.5	5,000	55	4,700		
45							38.5	4,300	49.5	4,100		
50							29	3,500	43.5	3,350		
55							19	2,400	37	2,300		
60								29	2,500	41.5	2,300	
70								17	1,800	35.5	2,100	
75									28	1,700	18	1,200

LOADLINE EQUIPMENT DEDUCT

DOWNHAUL WEIGHT = 150
ONE SHEAVE BLOCK = 200
TWO SHEAVE BLOCK = 355
THREE SHEAVE BLOCK = 530

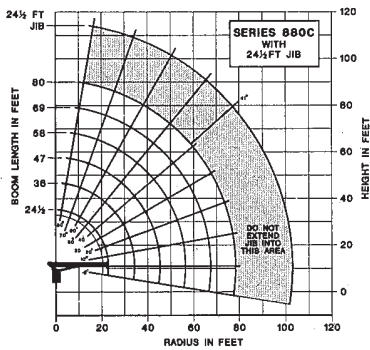

LOAD RATINGS												
LOAD RADIUS (FEET)	LOADED BOOM ANGLE	24½ FT BOOM (LBS)	36 FT BOOM (LBS)	47 FT BOOM (LBS)	58 FT BOOM (LBS)	69 FT BOOM (LBS)	80 FT BOOM (LBS)	91 FT BOOM (LBS)	102 FT BOOM (LBS)	113 FT BOOM (LBS)		
5	77.5	42,000										
8	70	29,200										
10	64.5	24,200	73.5	22,200	78	20,800						
12	58.5	20,900	70	19,000	75.5	17,500	78.5	16,200				
14	52.5	18,200	66.5	16,800	73	15,300	76.5	14,100	79.5	13,200		
16	46	16,200	63	14,700	70	13,500	74.5	12,600	77.5	11,700		
20	29	12,200	55	11,900	64.5	11,000	70	10,100	74	9,800		
25			44	9,500	57.5	8,900	65	8,200	69.5	7,600		
30			31	7,400	50	7,300	59	6,700	65	6,300		
35					41	6,100	53	5,700	60	5,400		
40					30	4,900	46.5	4,800	55	4,600		
45							38.5	4,100	49.5	4,000		
50							29	3,300	43.5	3,250		
55							19	2,200	37	2,100		
60								29	2,400	41.5	2,400	
70								17	1,700	35.5	2,000	
75									28	1,800	18	1,100

LOAD RADIUS (FEET)	LOADED BOOM ANGLE	24½ FT JIB (LBS)
20	79.5	5,600
25	77	4,900
30	74	4,300
35	71	3,850
40	68	3,100
45	65	2,600
50	62	2,200
55	59	1,900
60	55.5	1,600
65	52	1,350
70	48.5	1,100
75	45	850
80	41	650
90		

LOADLINE EQUIPMENT DEDUCT
DOWNHAUL WEIGHT = 150
ONE SHEAVE BLOCK = 200
TWO SHEAVE BLOCK = 355
THREE SHEAVE BLOCK = 530

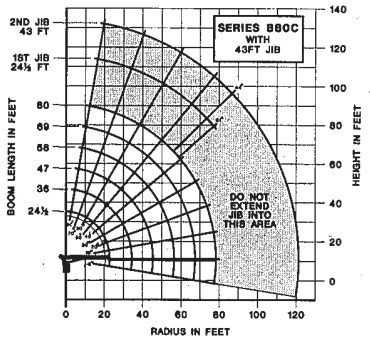

LOAD RATINGS												
LOAD RADIUS (FEET)	LOADED BOOM ANGLE	24½ FT BOOM (LBS)	36 FT BOOM (LBS)	47 FT BOOM (LBS)	58 FT BOOM (LBS)	69 FT BOOM (LBS)	80 FT BOOM (LBS)	91 FT BOOM (LBS)	102 FT BOOM (LBS)	113 FT BOOM (LBS)		
5	77.5	42,000										
8	70	29,200										
10	64.5	24,200	73.5	22,200	78	20,800						
12	58.5	20,900	70	19,000	75.5	17,500	78.5	16,200				
14	52.5	18,200	66.5	16,800	73	15,300	76.5	14,100	79.5	13,200		
16	46	16,200	63	14,700	70	13,500	74.5	12,600	77.5	11,700		
20	29	12,200	55	11,900	64.5	11,000	70	10,100	74	9,800		
25			44	9,500	57.5	8,900	65	8,200	69.5	7,600		
30			31	7,400	50	7,300	59	6,700	65	6,300		
35					41	6,100	53	5,700	60	5,400		
40					30	4,900	46.5	4,800	55	4,600		
45							38.5	4,100	49.5	4,000		
50							29	3,300	43.5	3,250		
55							19	2,200	37	2,100		
60								29	2,400	41.5	2,400	
70								17	1,700	35.5	2,000	
75									28	1,800	18	1,100

LOAD RADIUS (FEET)	LOADED BOOM ANGLE	24½ FT JIB (LBS)	43 FT JIB (LBS)	
20	79.5	5,600		
25	77	4,900	77	3,350
30	74	4,300	74	3,000
35	71	3,850	75	2,650
40	68	3,100	72.5	2,400
45	65	2,600	70	2,200
50	62	2,200	67.5	2,000
55	59	1,900	65	1,800
60	55.5	1,600	62.5	1,600
65	52	1,350	60	1,400
70	48.5	1,100	57	1,200
75	45	850	54	1,000
80	41	650	51	850
85			48	700
90			44	550

LOADLINE EQUIPMENT DEDUCT
DOWNHAUL WEIGHT = 150
ONE SHEAVE BLOCK = 200
TWO SHEAVE BLOCK = 355
THREE SHEAVE BLOCK = 530

The capacities shown will be reduced when accessories are attached to the boom or loadline. Rated loads do not exceed 85% of the tipping load. Structural strength ratings in the charts below are shaded.

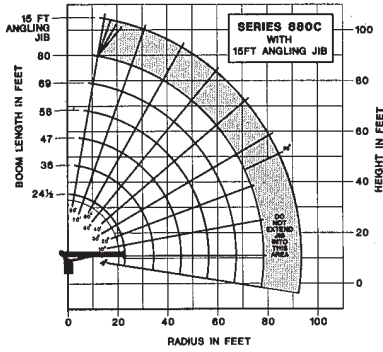

LOAD RATINGS											MAIN BOOM ANGLE							
LOAD RADIUS (FEET)	LOADED BOOM ANGLE	24 1/2 FT BOOM (LBS)	LOADED BOOM ANGLE	28 FT BOOM (LBS)	LOADED BOOM ANGLE	47 FT BOOM (LBS)	LOADED BOOM ANGLE	58 FT BOOM (LBS)	LOADED BOOM ANGLE	68 FT BOOM (LBS)	LOADED BOOM ANGLE	80 FT BOOM (LBS)	LOAD RADIUS (FEET)	JIB IN LINE	JIB OFFSET 10°	JIB OFFSET 21°	JIB OFFSET 30°	RATED LOAD (LBS)
5	77.5	42,000											20	79	79.5			6,000
8	70	29,200											25	76	76.5	78	79	5,000
10	64.5	24,200	73.5	22,200	78	20,600							30	73	73.5	75	78	4,500
12	58.5	20,900	70	19,000	75.5	17,500	78.5	16,200					35	70	70.5	71.5	72.5	4,050
14	52.5	18,200	66.5	16,800	73	15,300	76.5	14,100	79.5	13,200			40	66.5	67	68	89	3,800
18	46	15,900	63	14,700	70	13,500	74.5	12,500	77.5	11,700	79.5	11,300	45	63	63.5	64.5	85.5	3,150
20	29	12,200	55	11,900	64.5	11,000	70	10,100	74	9,800	76.5	9,100	50	59.5	60	61	62	2,760
25			44	9,500	57.5	8,900	65	8,200	69.5	7,800	72.5	7,200	55	55.5	58	57	58	2,400
30			31	7,400	50	7,300	59	6,700	66	6,300	68.5	5,950	60	51.5	52	53	54	2,050
35					41	6,100	53	5,700	60	5,400	64.5	5,000	65	47.5	48	49	49.5	1,750
40					30	4,900	46.5	4,800	55	4,800	60.5	4,300	70	43	43.5	44.5	45	1,500
45							38.5	4,100	49.5	4,000	58.5	3,750	75	38	38.5	39.5	40	1,220
50							29	3,300	43.5	3,400	52	3,250	80	32	33	33.5	34	950
55							19	2,200	37	2,900	47	2,800	85	25	26	26	28	690
60									29	2,400	41.5	2,400						
65									17	1,700	35.5	2,000						
70											28	1,800						
75											18	1,100						

LOADLINE EQUIPMENT DEDUCT
 DOWNHAUL WEIGHT = 150
 ONE SHEAVE BLOCK = 200
 TWO SHEAVE BLOCK = 355
 THREE SHEAVE BLOCK = 530

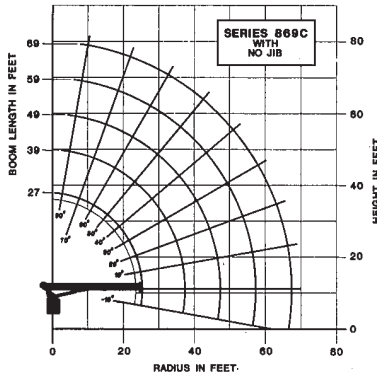

LOAD RATINGS											LOADLINE EQUIPMENT DEDUCT			
LOAD RADIUS (FEET)	LOADED BOOM ANGLE	27 FT BOOM (LBS)	LOADED BOOM ANGLE	39 FT BOOM (LBS)	LOADED BOOM ANGLE	49 FT BOOM (LBS)	LOADED BOOM ANGLE	59 FT BOOM (LBS)	LOADED BOOM ANGLE	69 FT BOOM (LBS)	DOWNHAUL WEIGHT	ONE SHEAVE BLOCK	TWO SHEAVE BLOCK	THREE SHEAVE BLOCK
5	79	42,000									150	200	355	530
8	72	28,600												
10	67	23,800	75	21,800	78.5	20,600								
12	62	20,100	72	18,500	76	17,400	79	16,600						
14	57	17,500	68.5	16,100	73.5	15,100	78.5	14,300	78	13,700				
18	51.5	15,600	65	14,300	71	13,300	74.5	12,800	77	12,100				
20	38.5	12,200	58.5	11,600	66	10,800	70.5	10,200	74	9,700				
25			49	9,200	59	8,650	65	8,200	69.5	7,800				
30			37.5	7,400	51.5	7,150	59.5	6,750	65	6,400				
35			21	5,500	43.5	6,000	53.5	5,700	60	5,400				
40					33.5	4,900	47	4,850	54.5	4,850				
45					19	3,600	39.5	4,150	49	4,000				
50							31	3,450	43	3,450				
55							17.5	2,800	36.5	2,900				
60									28.5	2,400				
65									16	1,700				

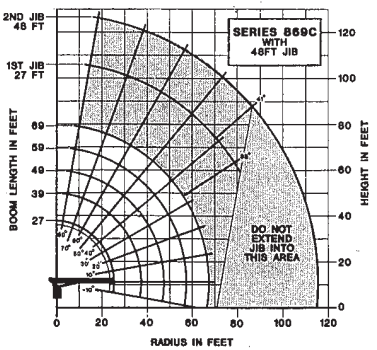

LOAD RATINGS											LOADLINE EQUIPMENT DEDUCT				
LOAD RADIUS (FEET)	LOADED BOOM ANGLE	27 FT BOOM (LBS)	LOADED BOOM ANGLE	39 FT BOOM (LBS)	LOADED BOOM ANGLE	49 FT BOOM (LBS)	LOADED BOOM ANGLE	59 FT BOOM (LBS)	LOADED BOOM ANGLE	69 FT BOOM (LBS)	DOWNHAUL WEIGHT	ONE SHEAVE BLOCK	TWO SHEAVE BLOCK	THREE SHEAVE BLOCK	
5	79	42,000									150	200	355	530	
8	72	28,200													
10	67	23,200													
12	62	19,700	75	21,500	78.5	20,400	79	16,400							
14	57	17,100	72	16,200	76	17,200	78.5	14,100	79	13,600					
18	51.5	15,100	68.5	15,800	73.5	14,800	74.5	12,400	77	12,000					
20	38.5	11,800	65	14,000	71	13,100	70.5	10,000	74	9,800					
25			55.5	11,300	66	10,600	65	8,000	69.5	7,700					
30			49	8,900	59	8,450	59.5	6,550	65	6,300					
35			37.5	7,100	51.5	6,950	53.5	5,500	60	5,300					
40			21	5,200	43.5	5,800	47	4,950	54.5	4,550					
45					33.5	4,700	39.5	3,950	49	3,900					
50					19	3,400	31	3,250	43	3,350					
55							17.5	2,300	36.5	2,600					
60									28.5	2,300					
65									16	1,600					

National Series 800C Truck Specifications

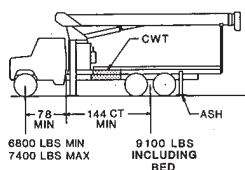
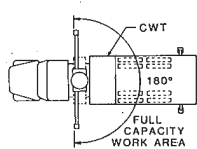
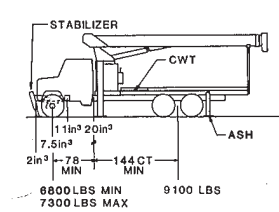
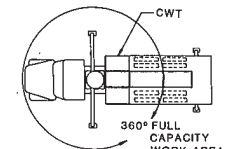
Mounting Configurations	Configuration 1 with Torsion Box	Configuration 2 with Torsion Box
	The versatility of the Series 800C can be enhanced by the mounting configurations described at the right. The configurations are based on the Series 800C with an 85% stability factor. The complete unit must be installed in accordance with factory requirements and a test performed to determine actual stability and counterweight requirements since individual truck chassis vary.	This configuration is the least expensive method for the Series 800C. This mount, with the crane mounted behind the cab, requires the least weight of all mounts for stability, thus, you can haul larger payloads on your truck. It requires standard subbase and rear (ASH) stabilizers.
Stable	180°	360°
Gross Axle Weight Rating (GAWR), front	12,000 lbs.	12,000 lbs.
Gross Axle Weight Rating (GAWR), rear	34,000 lbs.	34,000 lbs.
Wheelbase (WB)	222 inches	222 inches
Cab to axle/trunnion (CA/CT)	144 inches	144 inches
Frame Section Modulus (SM) under crane 50,000 PSI or	35.0 inch ³	Not applicable (see note above)
110,000 PSI	15.9 inch ³	20.0 inch ³
Frame Section Modulus (SM) over rear stabilizers: 50,000 PSI or	17.0 inch ³	Not applicable (see note above)
110,000 PSI	13.0 inch ³	13.0 inch ³
Stability Weight, Front	6,800 lbs. minimum* 7,400 lbs. maximum*	6,800 lbs. minimum* 7,300 lbs. maximum*
Stability Weight, Rear	9,100 lbs. minimum*	9,100 lbs. minimum*
Estimated Average Final Weight (880C)	35,000 lbs.	35,300 lbs.
Notes: (1) GAWR means Gross Axle Weight Rating and is dependent on all components of the vehicle such as axles, tires, springs, frame, etc., meeting manufacturer's recommendations. Always specify GAWR when purchasing trucks. (2) Minimum axle requirements may increase with use of longer wheelbase, service bodies, diesel engines, or front stabilizers. (3) Diesel engines require variable speed governor and energize-to-run fuel solenoid for smooth crane operation.	 	 
*Estimated axle scale weights prior to installation of crane, stabilizers, and subbase for 85% stability.		